

List of pages in this Trip Kit

Trip Kit Index
Departure and Destination ACA118
Entire Route ACA118
Strip Charts ACA118
Airport Information For CYVR
Terminal Charts For CYVR
Airport Information For CYYZ
Terminal Charts For CYYZ
Revision Letter For Cycle 09-2023
Change Notices
Notebook
FIR/UIR Communications
Operational Notes Operational Notes
Regional Notes Regional Notes
Reference Notes Reference Notes

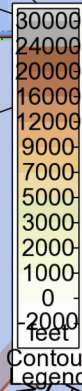

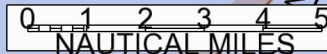

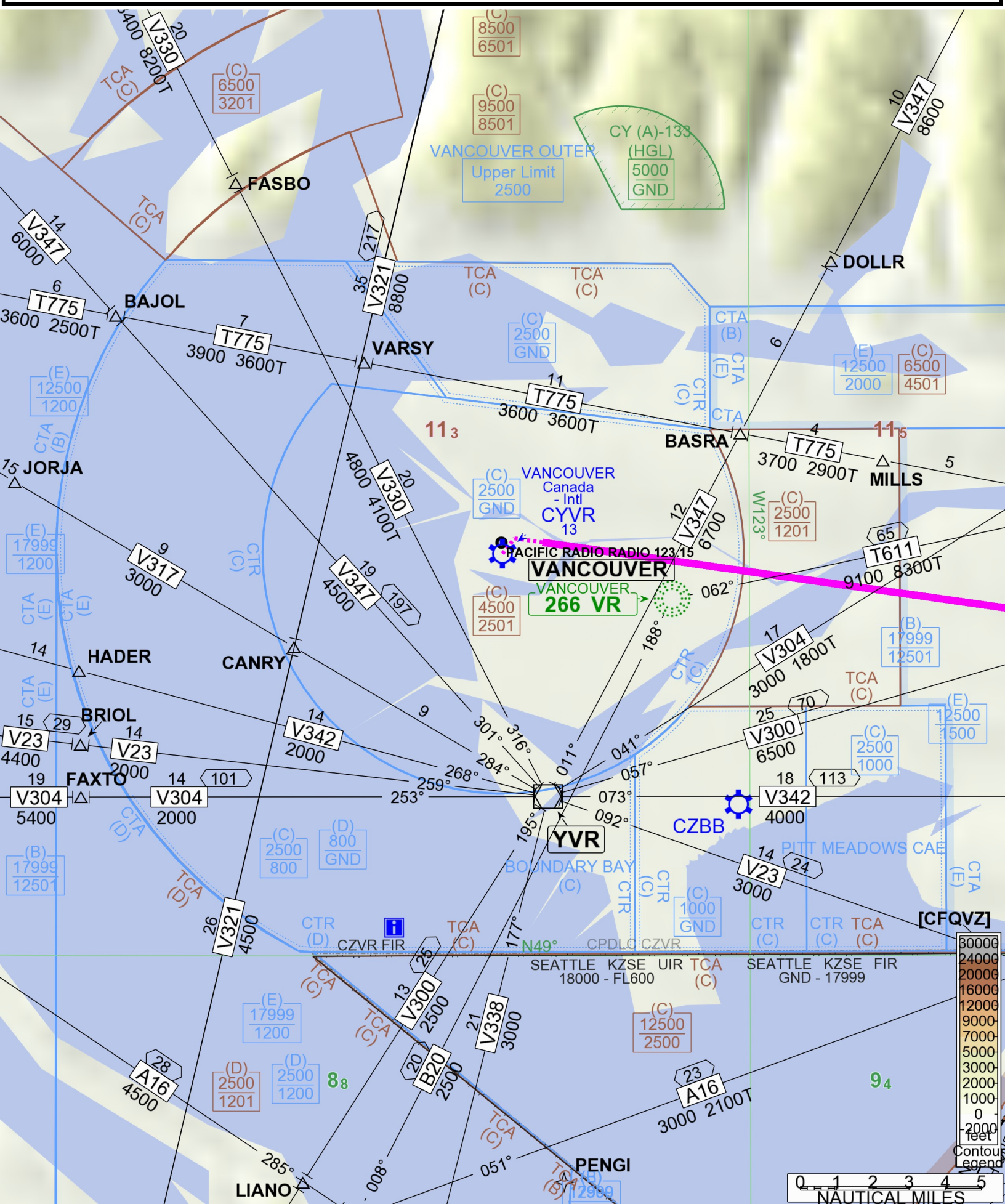
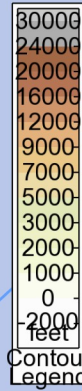
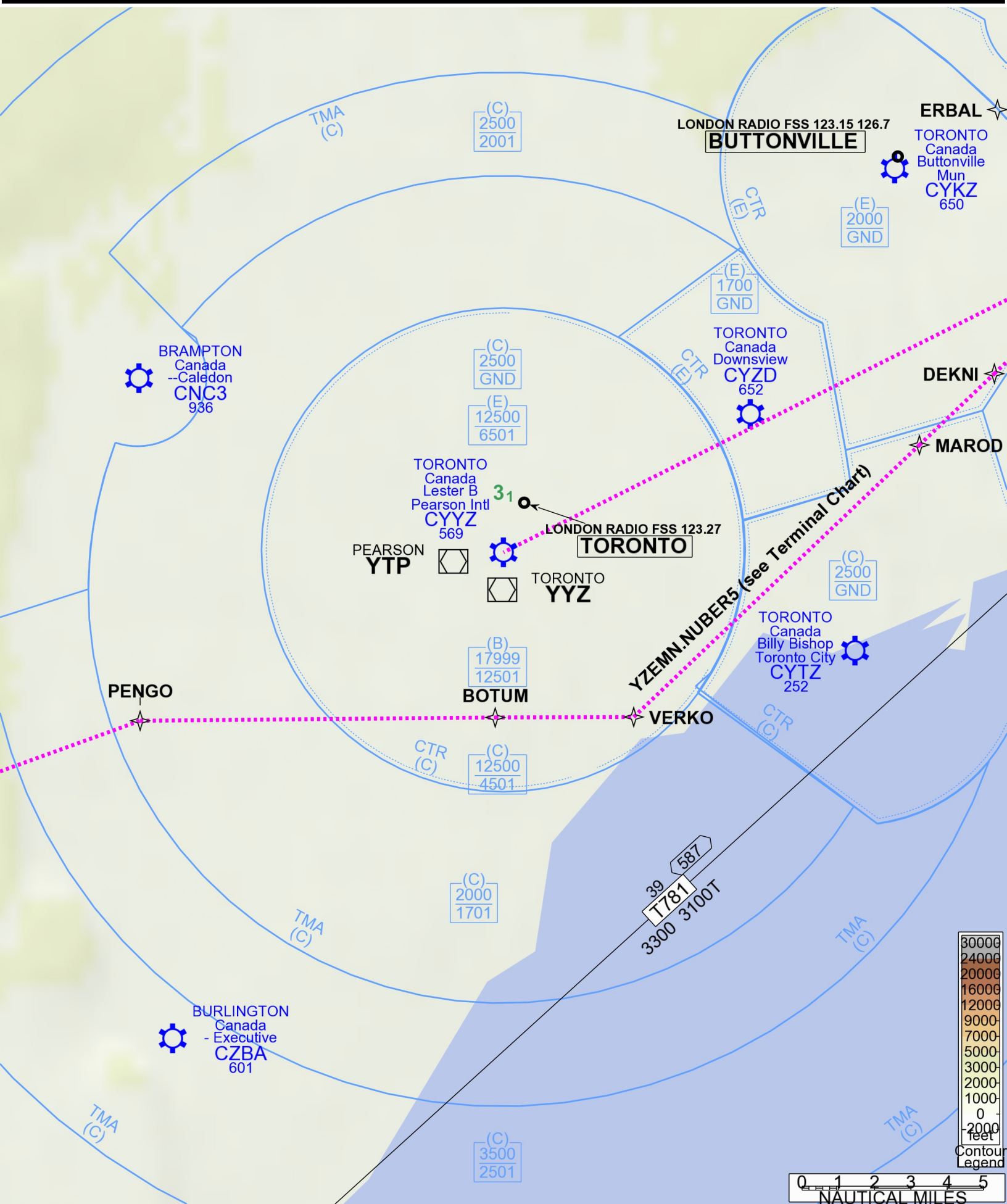
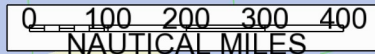
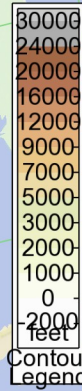

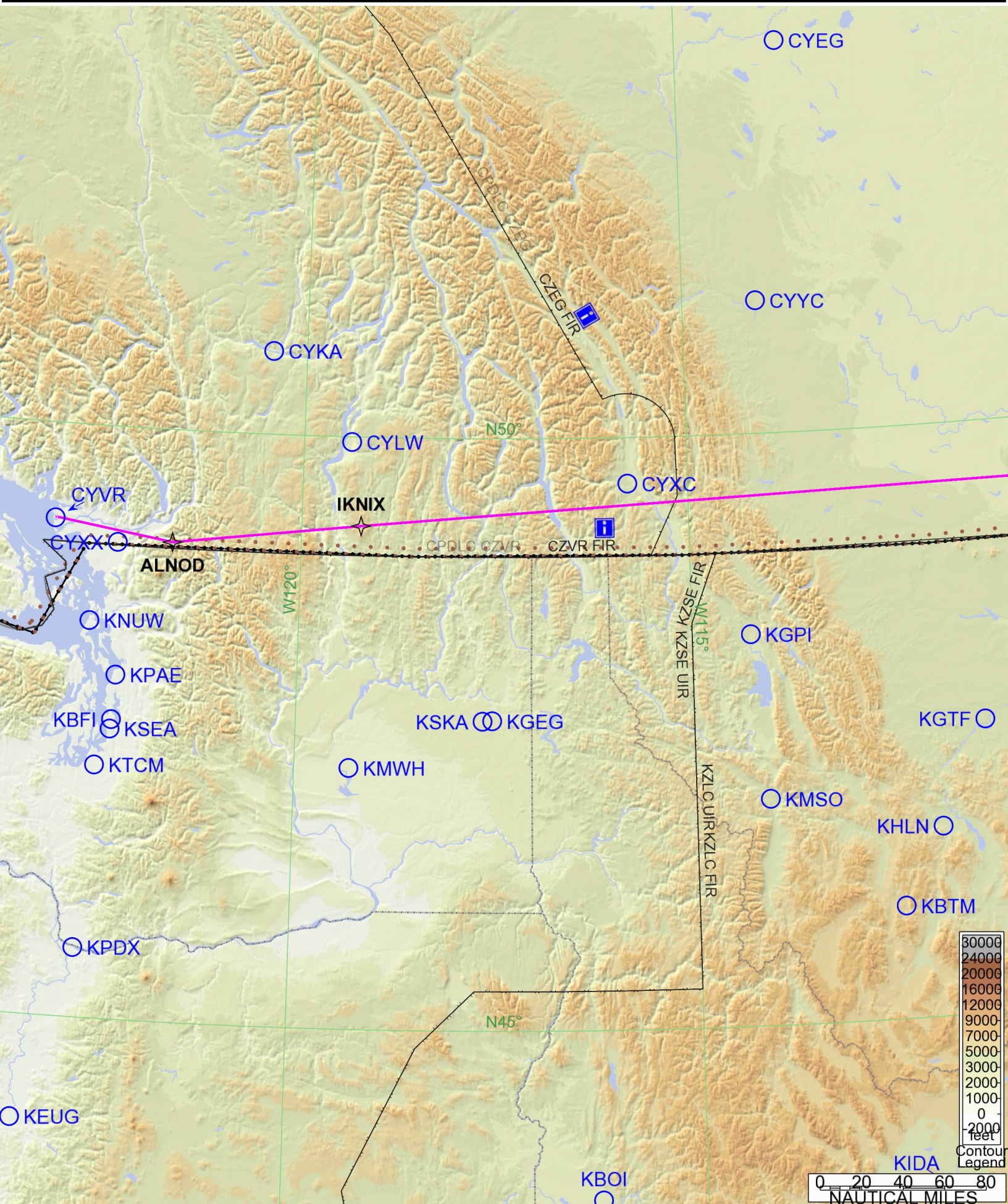

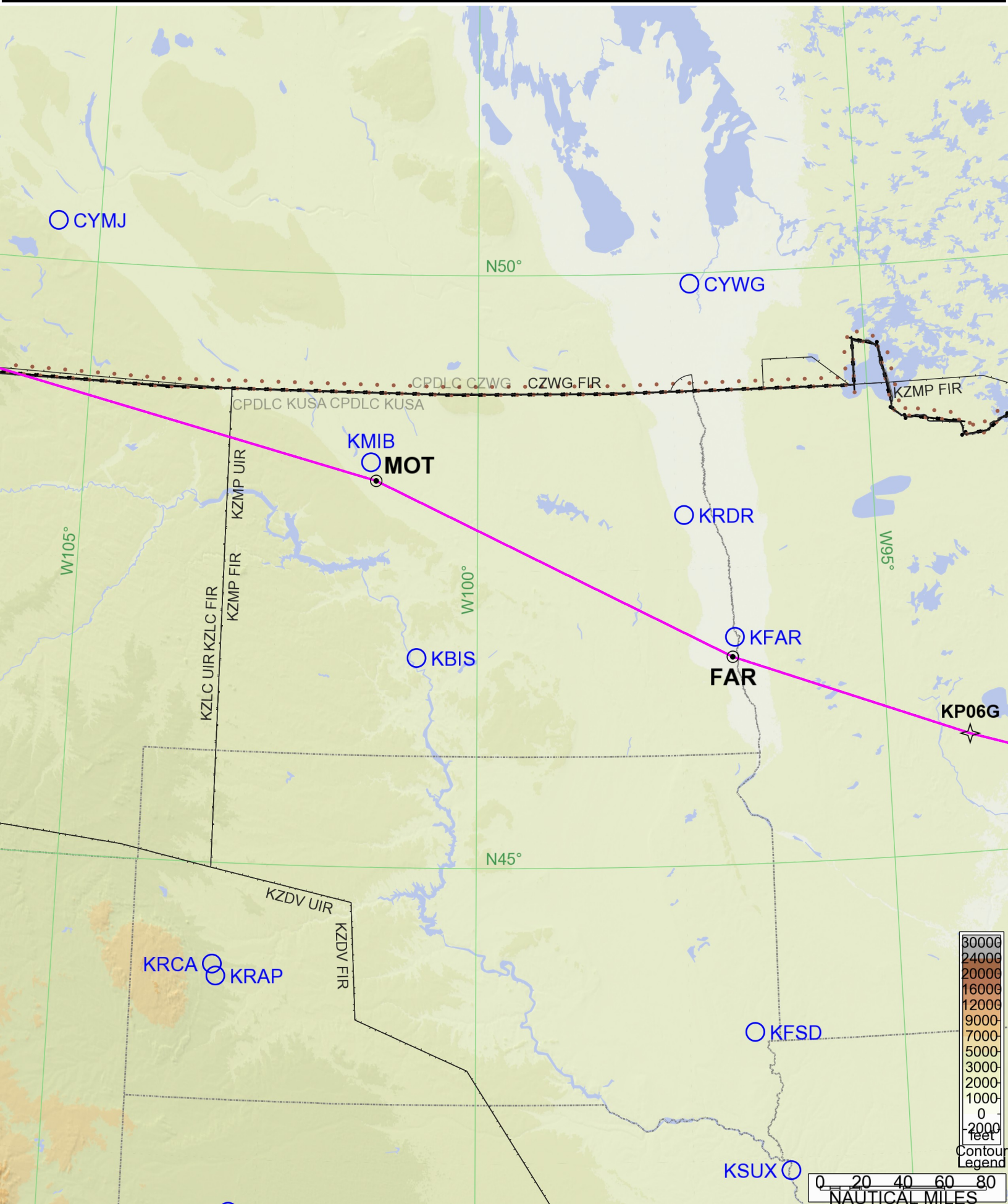

30000
24000
20000
16000
12000
9000
7000
5000
3000
2000
1000
0
-2000
feet

0 20 40 60 80
NAUTICAL MILES

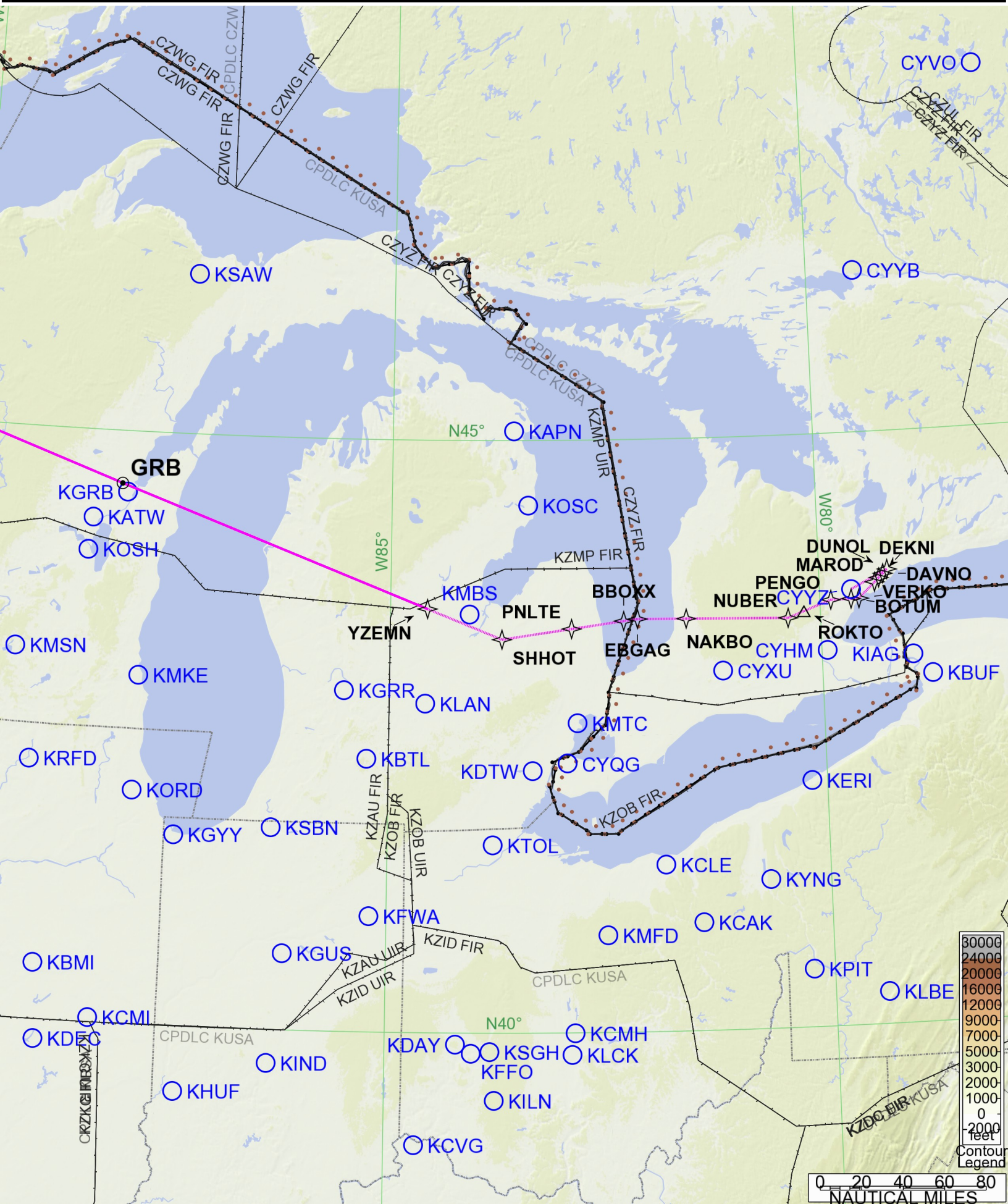

General Information

Location: VANCOUVER BC CAN
ICAO/IATA: CYVR / YVR
Lat/Long: N49° 11.7', W123° 11.0'
Elevation: 13 ft

Airport Use: Public
Daylight Savings: Observed
UTC Conversion: +8:00 = UTC
Magnetic Variation: 17.0° E

Fuel Types: 100 Octane (LL), Jet A, Jet A-1
Oxygen Types: High Pressure, Low Pressure
Repair Types: Major Airframe, Major Engine
Customs: Yes
Airport Type: IFR
Landing Fee: Yes
Control Tower: Yes
Jet Start Unit: Yes
LLWS Alert: No
Beacon: No

Sunrise: 1332 Z
Sunset: 0257 Z

Runway Information

Runway: 08L
Length x Width: 9941 ft x 200 ft
Surface Type: concrete
TDZ-Elev: 13 ft
Lighting: Edge, ALS, Centerline, TDZ

Runway: 08R
Length x Width: 10803 ft x 200 ft
Surface Type: asphalt
TDZ-Elev: 9 ft
Lighting: Edge, ALS, Centerline, TDZ

Runway: 13
Length x Width: 7300 ft x 200 ft
Surface Type: asphalt
TDZ-Elev: 8 ft
Lighting: Edge, ALS

Runway: 26L
Length x Width: 10803 ft x 200 ft
Surface Type: asphalt
TDZ-Elev: 7 ft
Lighting: Edge, ALS, Centerline, TDZ

Runway: 26R
Length x Width: 9941 ft x 200 ft
Surface Type: concrete
TDZ-Elev: 9 ft
Lighting: Edge, ALS, Centerline, TDZ

Runway: 31
Length x Width: 7300 ft x 200 ft
Surface Type: asphalt
TDZ-Elev: 8 ft
Lighting: Edge, ALS

Communication Information

ATIS: 124.600
Vancouver Tower: 118.700
Vancouver Tower: 125.650
Vancouver Tower: 124.025
Vancouver Tower: 119.550
Vancouver Ground: 127.150
Vancouver Ground: 121.700
Vancouver Clearance Delivery: 121.400
Vancouver Arrival: 128.175
Vancouver Arrival: 128.600
Vancouver Arrival: 133.100
Vancouver Arrival: 134.225
Vancouver Departure: 126.125
Vancouver Departure: 132.300
Pacific Radio Radio: 123.150 Flight Info Service RCO
Vancouver De-Ice Operations: 129.950
Vancouver Terminal Area: 125.200
Pad Control Operations: 131.975
Iceman Operations: 130.925
Iceman Operations: 130.700

CYVR/YVR
VANCOUVER INTL

JEPPesen

VANCOUVER, BC

17 FEB 23

10-2

Eff 23 Feb

RNAV STAR

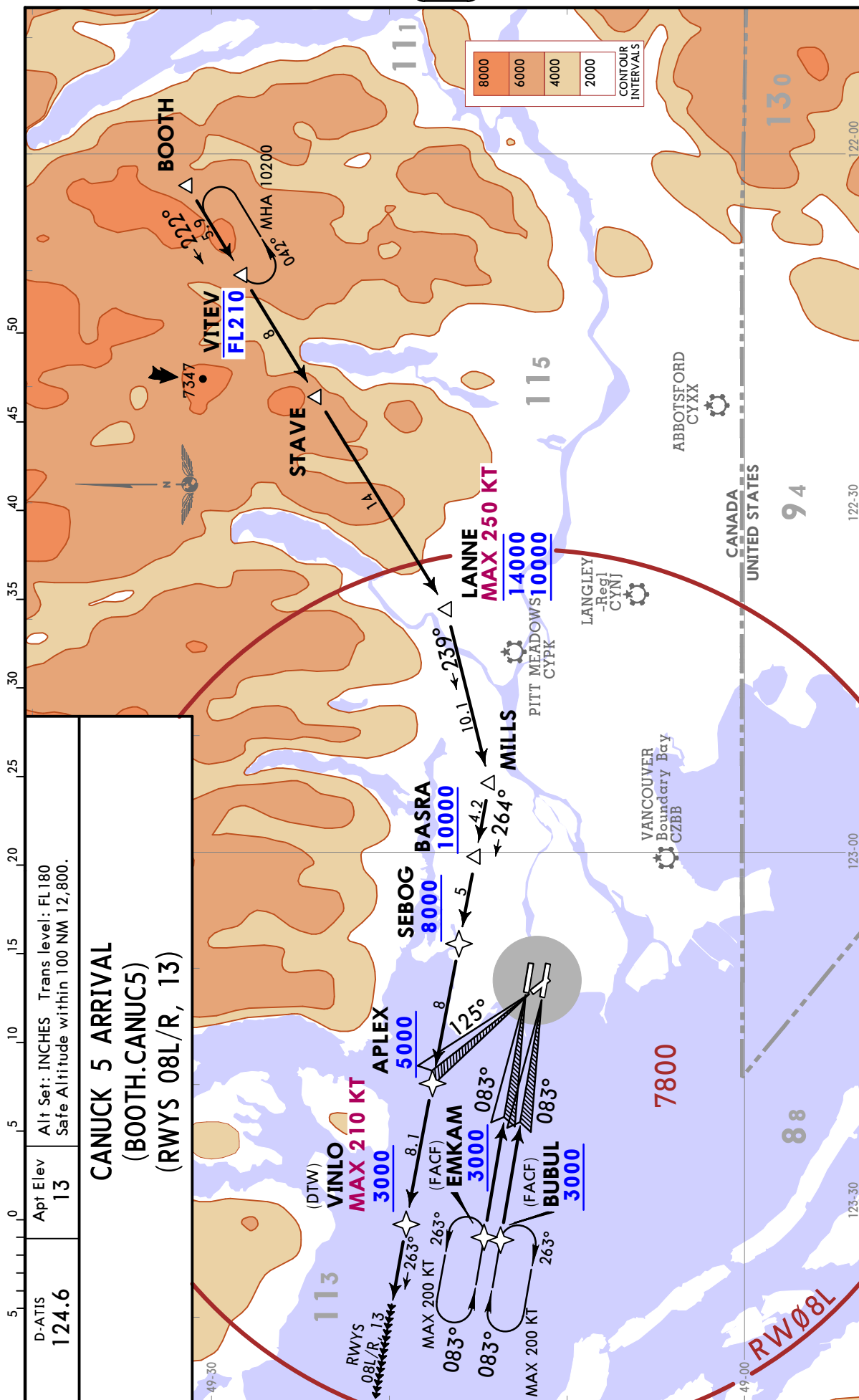

D-ATIS 124.6	Apt Elev 13	Alt Set: INCHES Trans level: FL180 Safe Altitude within 100 NM 12,800.
------------------------	----------------	--

CANUCK 5 ARRIVAL
(BOOTH.CANUC5)
(RWYS 08L/R, 13)

CHANGES: None.

© JEPPESEN, 2018, 2022. ALL RIGHTS RESERVED.

CYVR/YVR
VANCOUVER INTL

JEPPESEN
17 FEB 23 **10-2A** Eff 23 Feb

VANCOUVER, BC
RNAV STAR

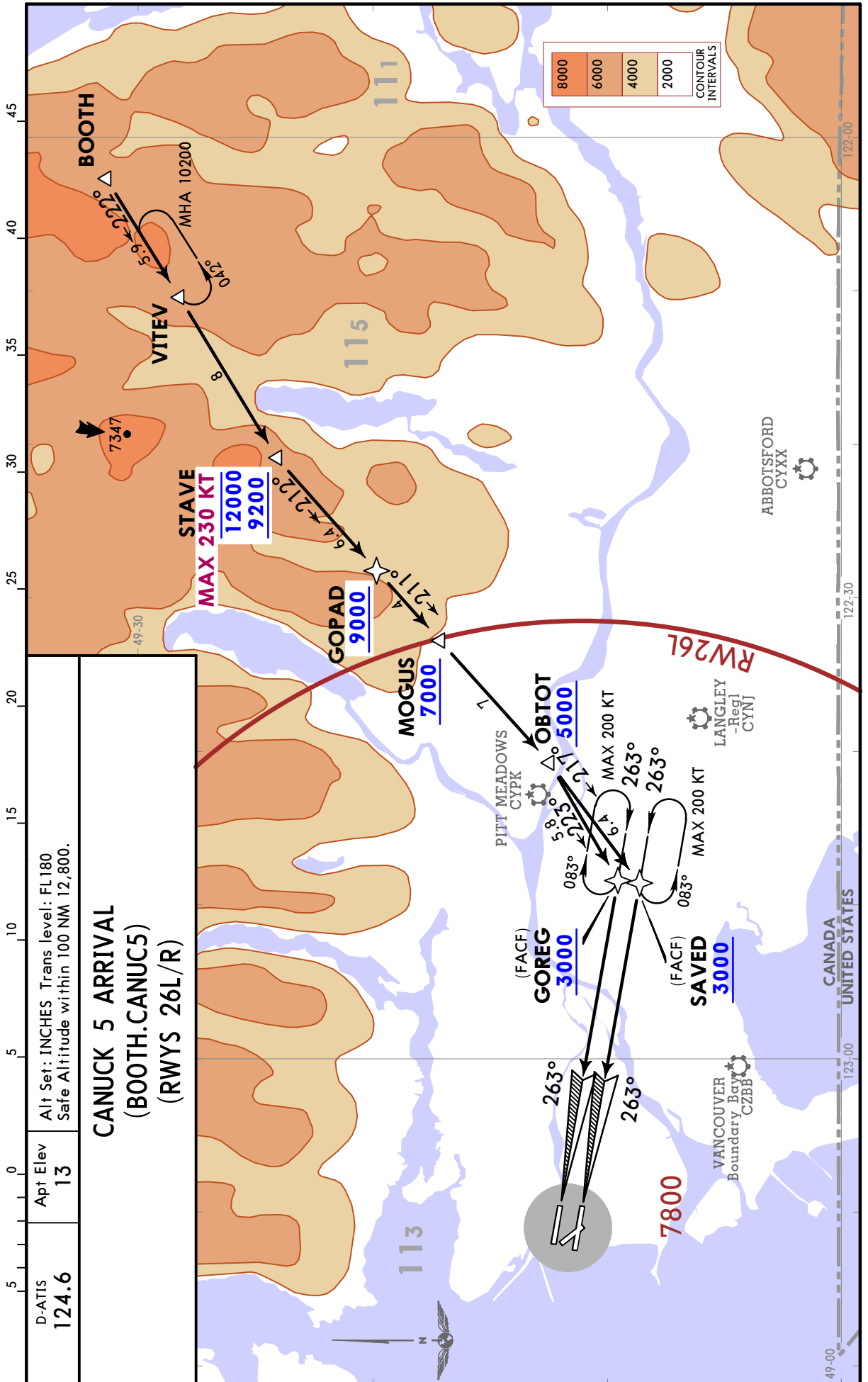

CHANGES: MSA revised.

CYVR/YVR
VANCOUVER INTL

JEPPesen
17 FEB 23 **10-2B** Eff 23 Feb

VANCOUVER, BC
RNAV STAR

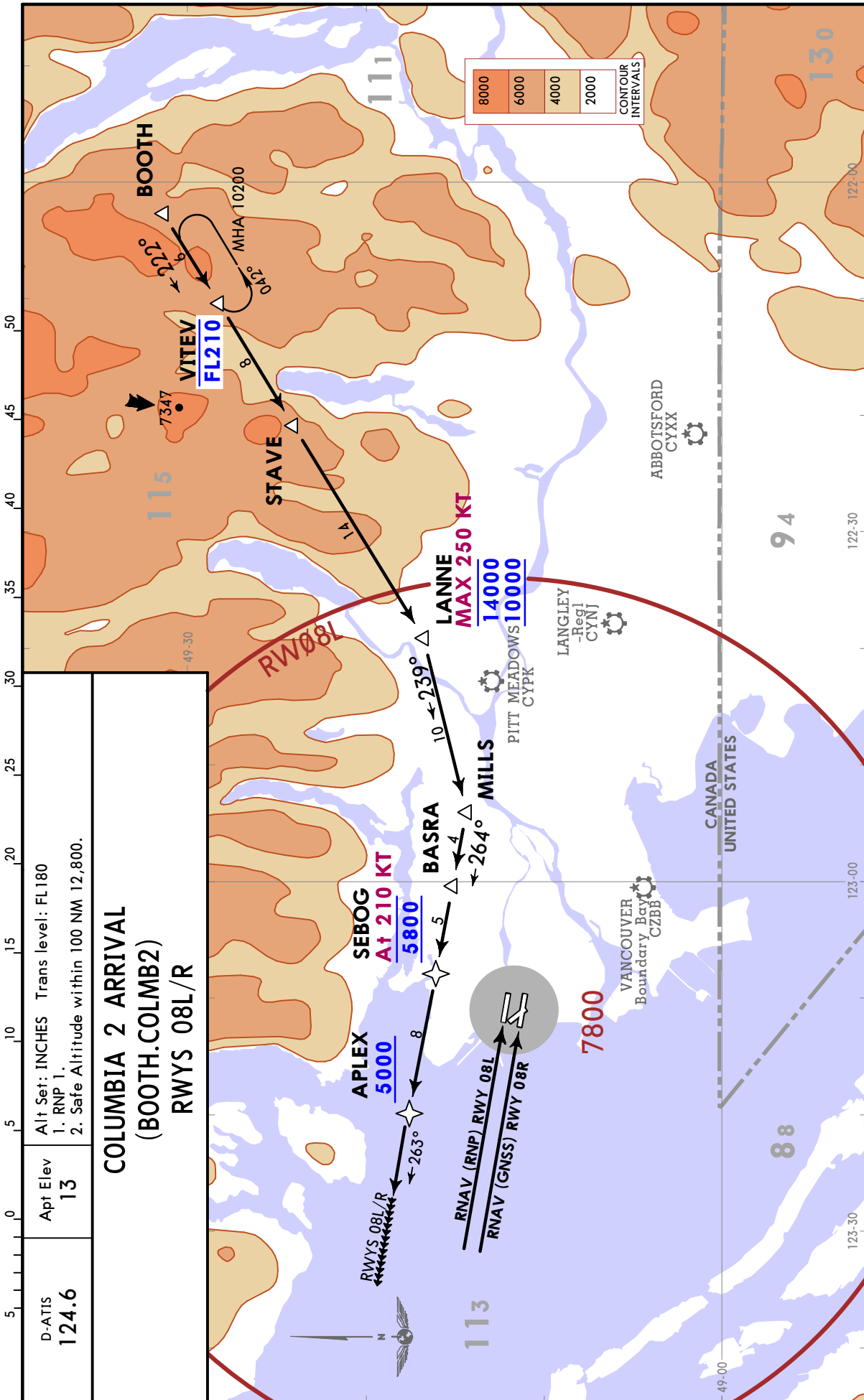

CHANGES: None.

© JEPPESEN, 2018, 2022. ALL RIGHTS RESERVED.

CYVR/YVR
VANCOUVER INTL

JEPPESEN

VANCOUVER, BC

17 FEB 23

10-2C

Eff 23 Feb

RNAV STAR

D-ATIS
124.6

Apt Elev
13

Alt Set: INCHES Trans level: FL180
Safe Altitude within 100 NM 12,800.

DUXUM 5 ARRIVAL (DUXUM.DUXUM5) RWYS 26L/R

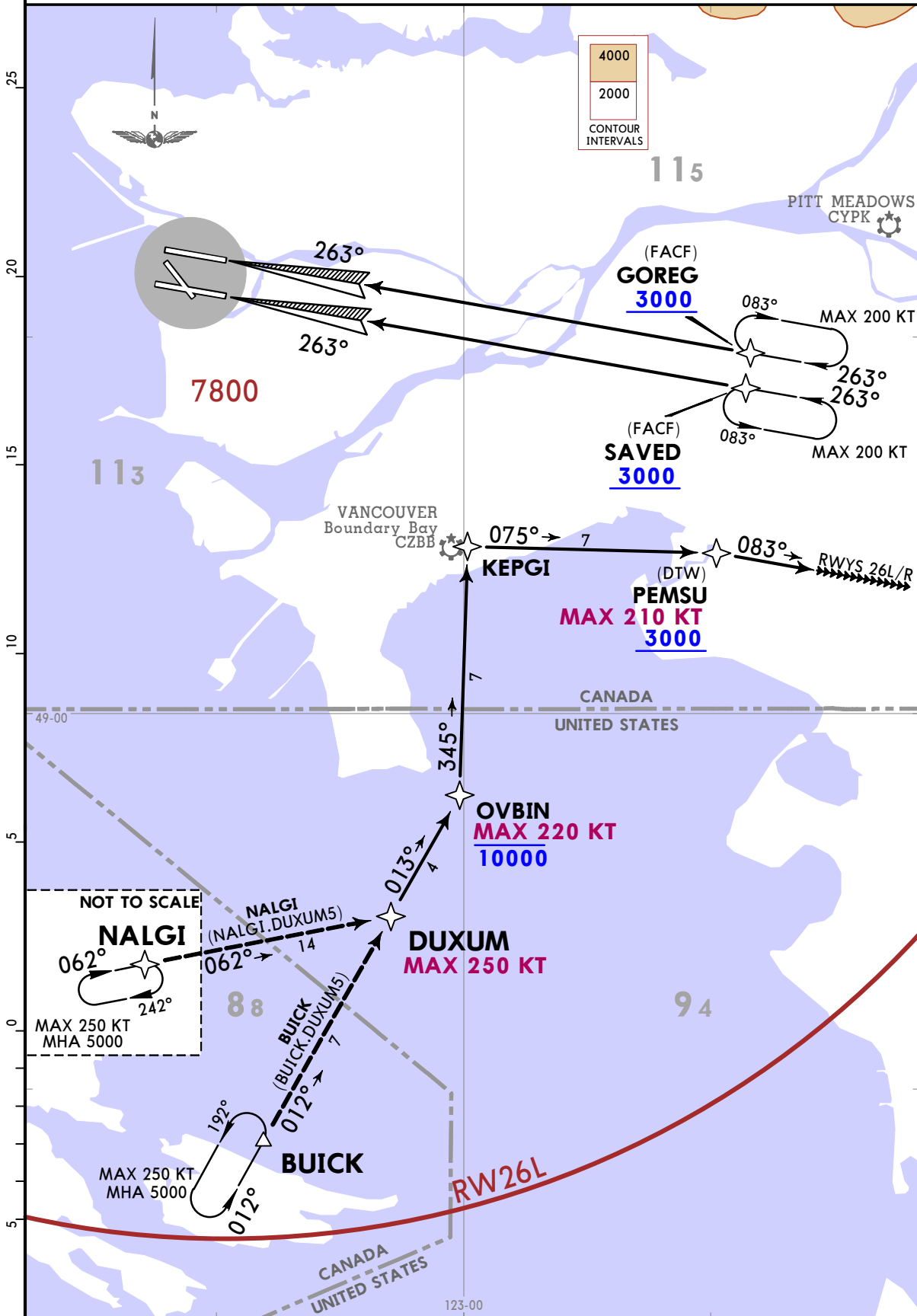

JEPPESEN VANCOUVER, BC
17 FEB 23 (10-2D) Eff: 23 Feb
RNAV STAR

D-ATIS 124.6
Apt Elev 13
Alt Set: INCHES Trans level: FL180
Safe Altitude within 100 NM 12,800.

**GRIZZ 7 ARRIVAL (EGRET.GRIZZ7)
RWYS 08L/R & 13**

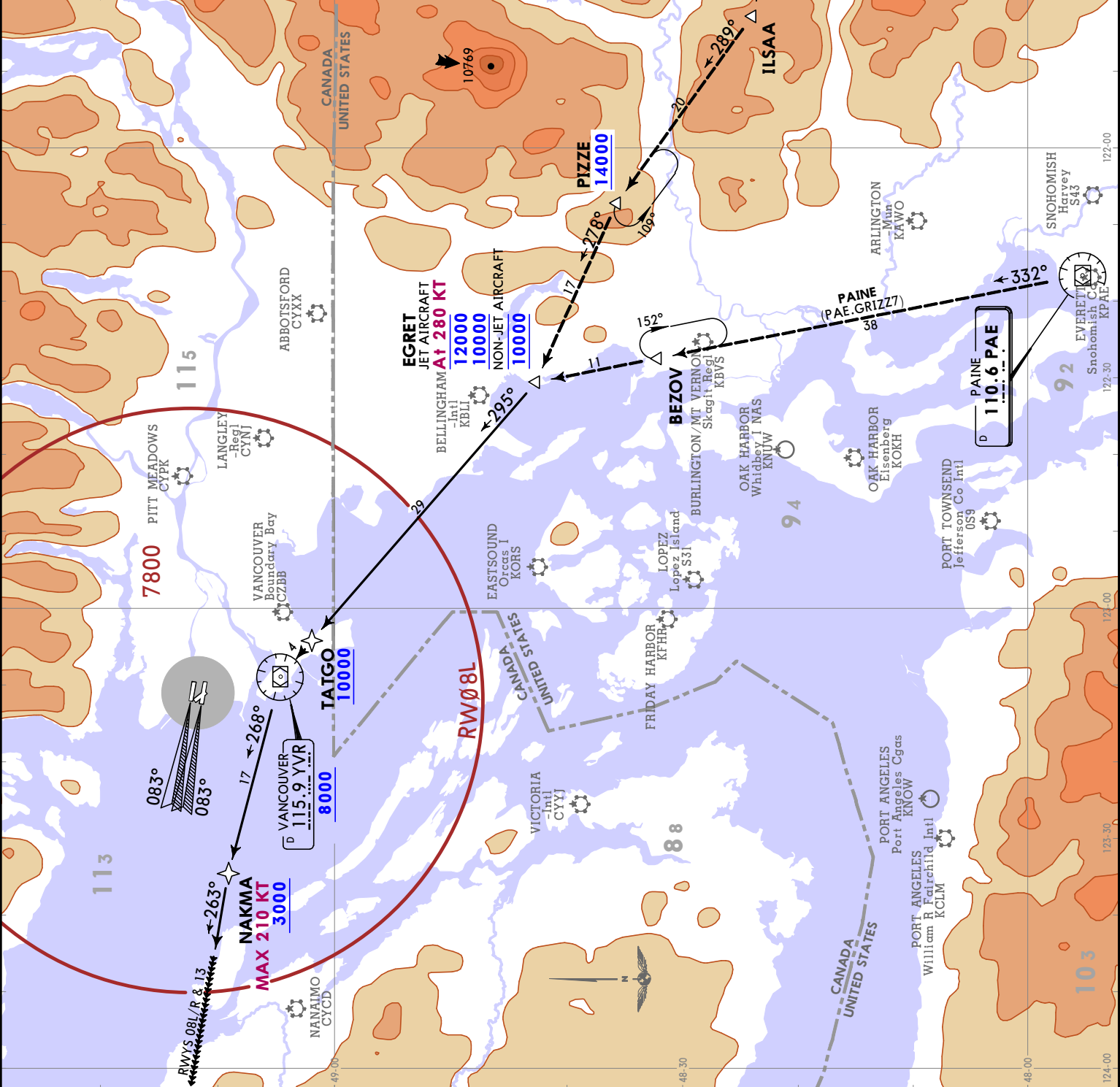

CYVR/YVR
VANCOUVER INTL

JEPPESEN VANCOUVER, BC
17 FEB 25 (10-2E) Eft 23 Feb RNAV STAR

CYVR/YVR
VANCOUVER INTL

D-ATIS
124.6

Apt Elev
13

Alt Set: INCHES Trans level: FL 180
Safe Altitude within 100 NM 12,800.

GRIZZ 7 ARRIVAL (EGRET.GRIZZ7)
RWYS 26L/R

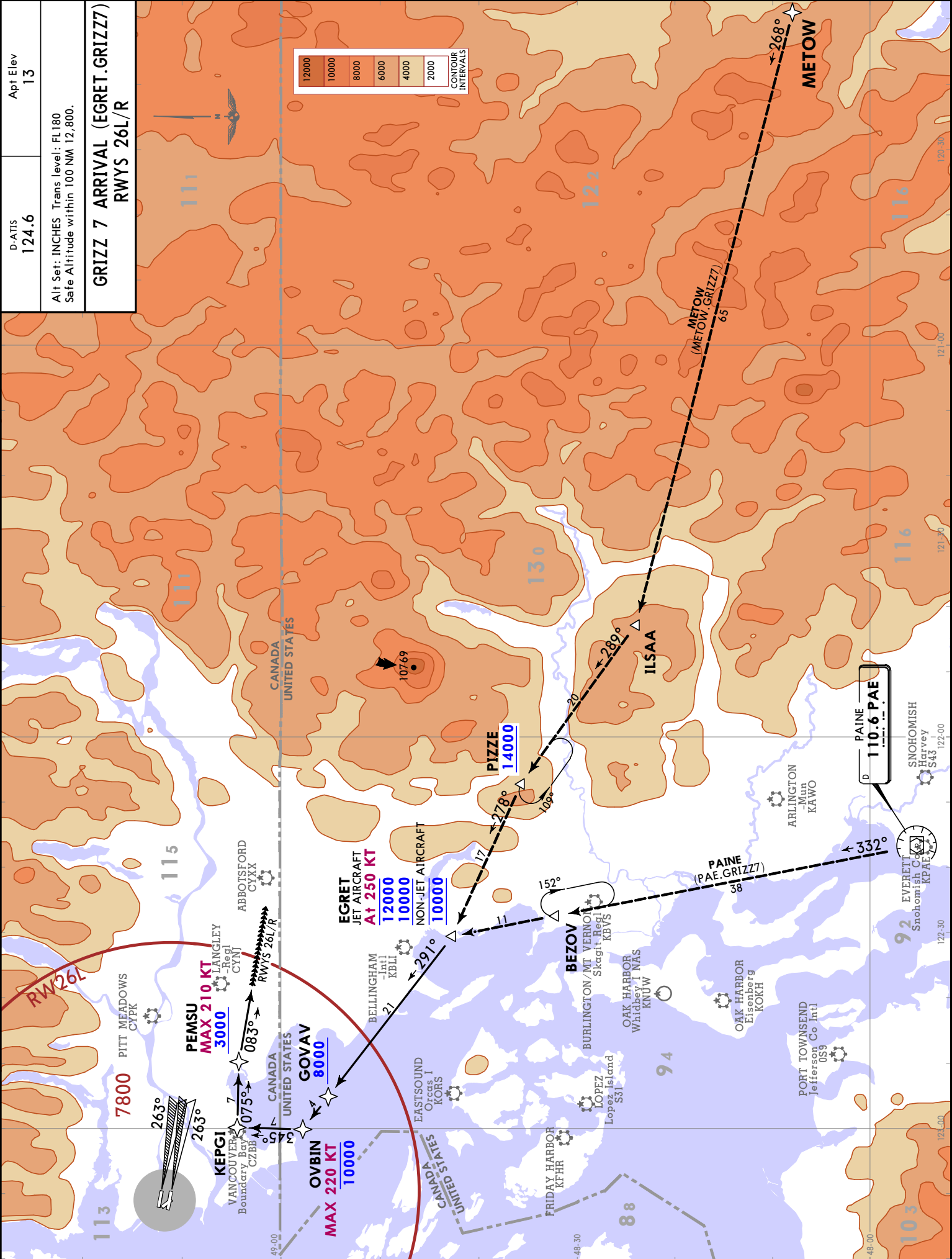
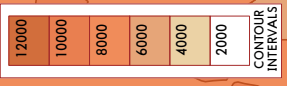

EGRET
JET AIRCRAFT
A+ 250 KT
12000
10000
NON-JET AIRCRAFT
10000

PEMSU
MAX 210 KT
3000

GOVAV
8000

OVBIN
MAX 220 KT
10000

PIZZE
14000

BEZOV
BURLINGTON / MT VERNON
Skagit-Regl
KBVS

PAINE
(PAE.GRIZZ7)

PAINE
110.6 PAE

EVERETT
Snohomish Co
KPAF

SNOHOMISH
Harvey
S43

CYVR/YVR
VANCOUVER INTL

JEPPESEN
5 AUG 22 (10-2F)

VANCOUVER, BC
RNAV STAR

D-ATIS 124.6	Apt Elev 13	Alt Set: INCHES Trans level: FL180 Safe Altitude within 100 NM 12,800.
------------------------	-----------------------	---

ISLAND 5 ARRIVAL (MEPMU.ILAND5) (RWYS 08L/R, 13)

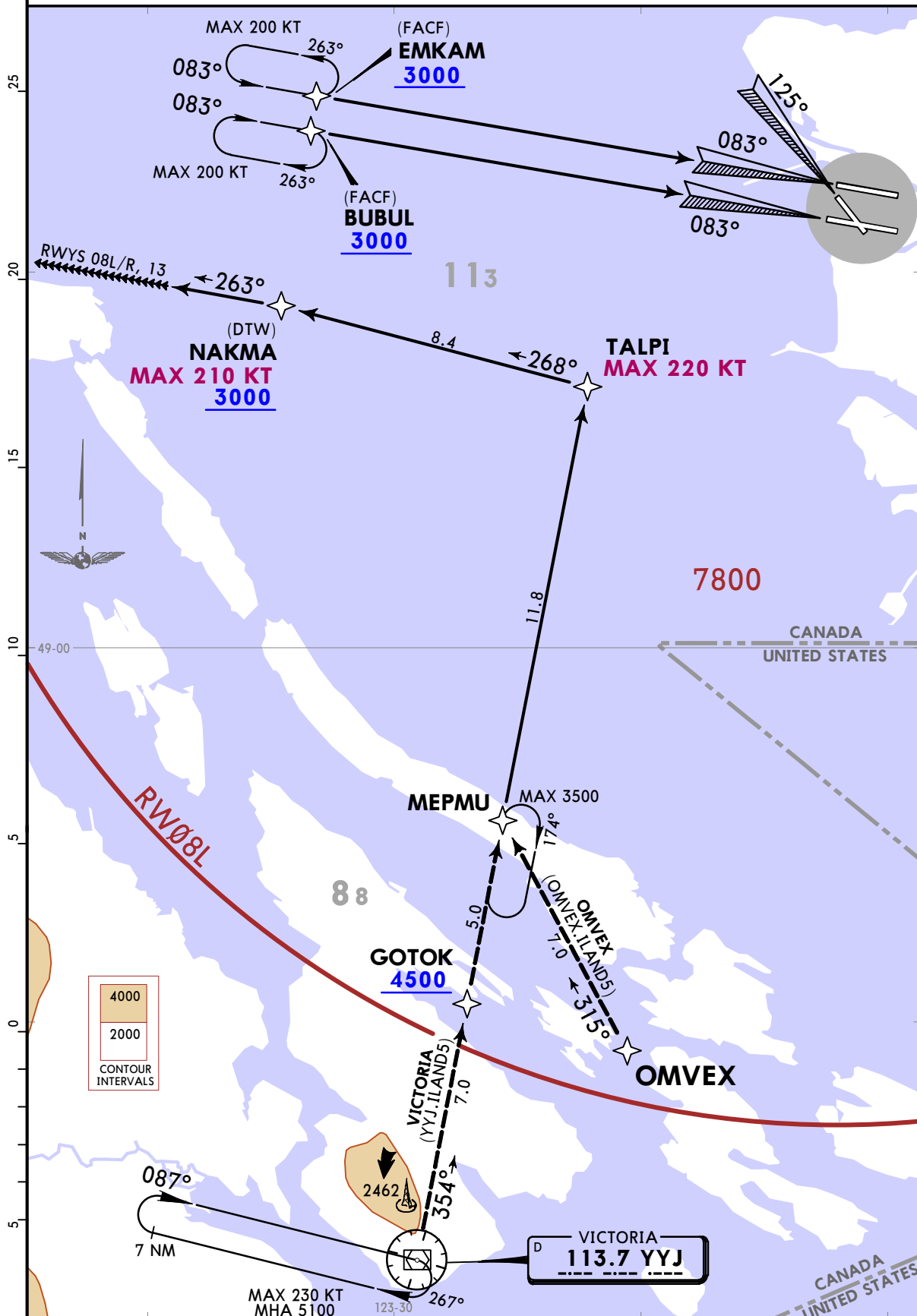

CHANGES: Reissue.

JEPESEN VANCOUVER, BC
STAR

D-ATIS 124.6
Apt Elev 13
Alt Set: INCHES
Trans level: FL180
Safe Altitude within 100 NM 12,800.
KEINN 2 ARRIVAL (KEINN.KEINN2)
RWYS 08L/R, 13, 26L/R

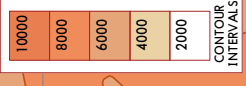

CYVR/YVR VANCOUVER INTL
PORT HARDY
112.0 YZT

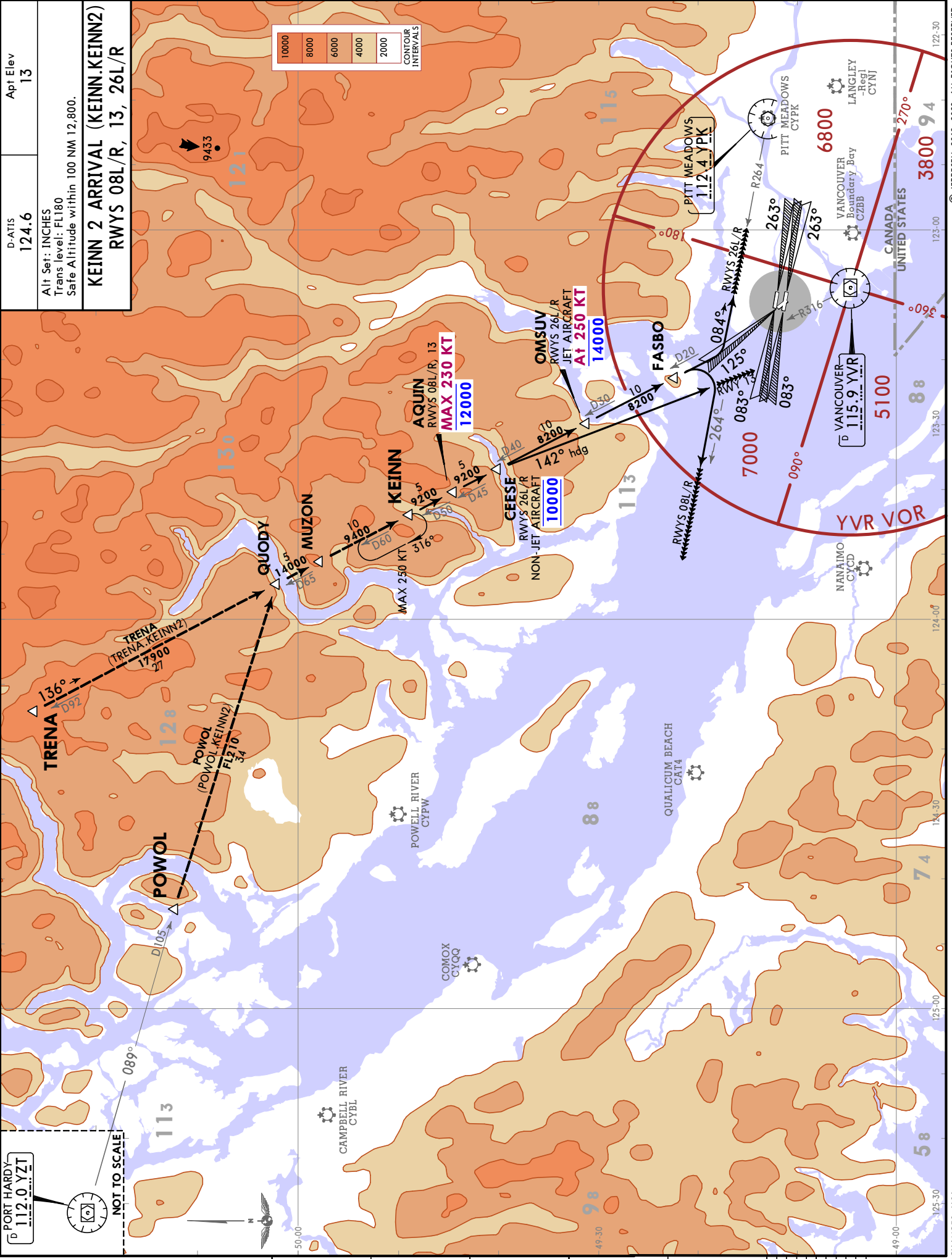
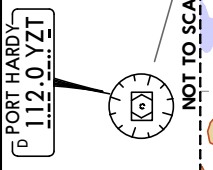

CYVR/YVR
VANCOUVER INTL

JEPPesen
2 SEP 22 **10-2J** Eff 8 Sep

VANCOUVER, BC
RNAV STAR

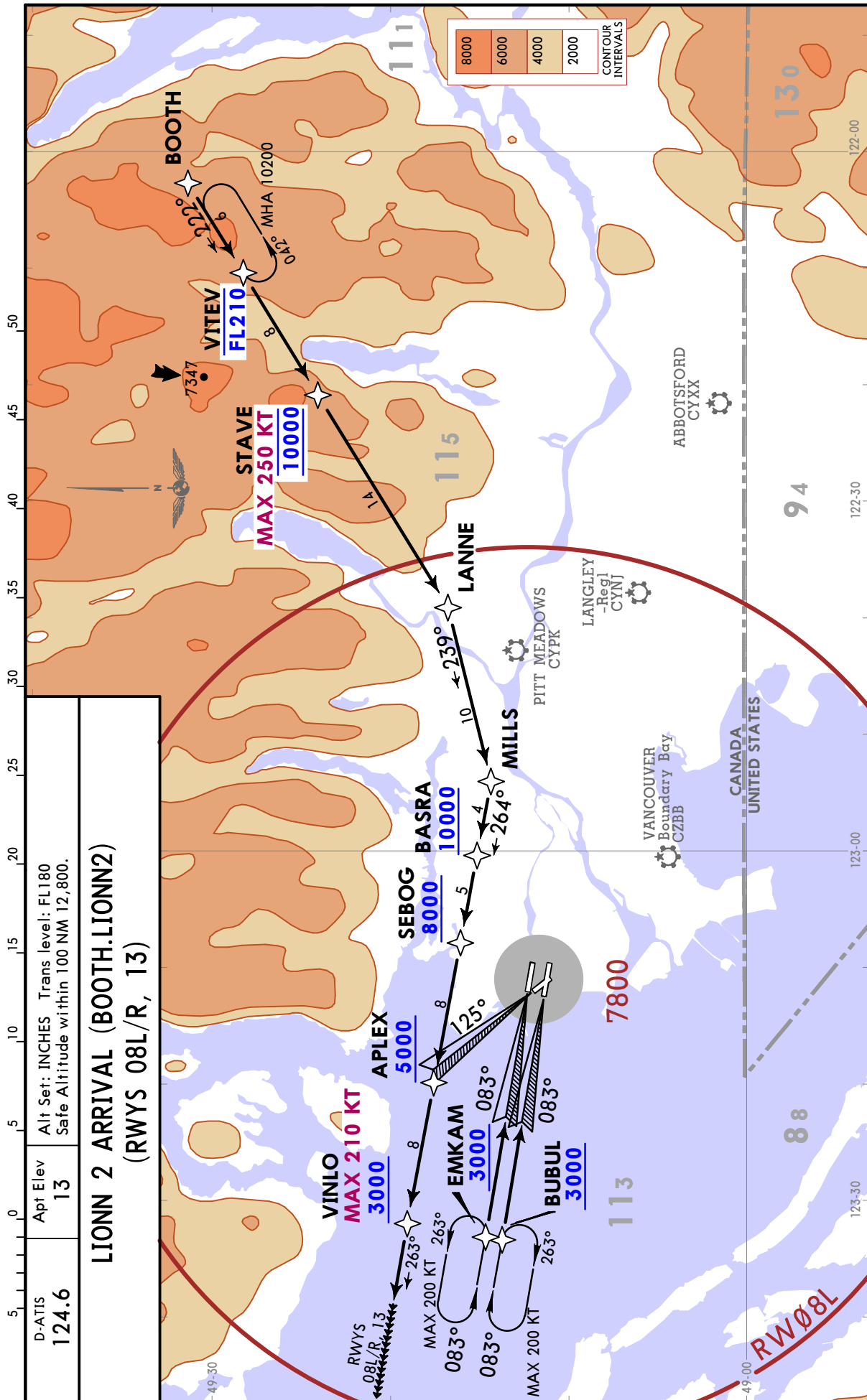

CHANGES: None.

© JEPPESEN, 2018, 2022. ALL RIGHTS RESERVED.

CYVR/YVR
VANCOUVER INTL

JEPPESEN
17 FEB 23 10-2L Eff 23 Feb

VANCOUVER, BC
STAR

D-ATIS 124.6	Apt Elev 13	Alt Set: INCHES Trans level: FL180 Safe Altitude within 100 NM 12,800.
-----------------	----------------	--

PAINE 4 ARRIVAL (PAE.PAINE4) RWYS 08L/R, 13, 26L/R

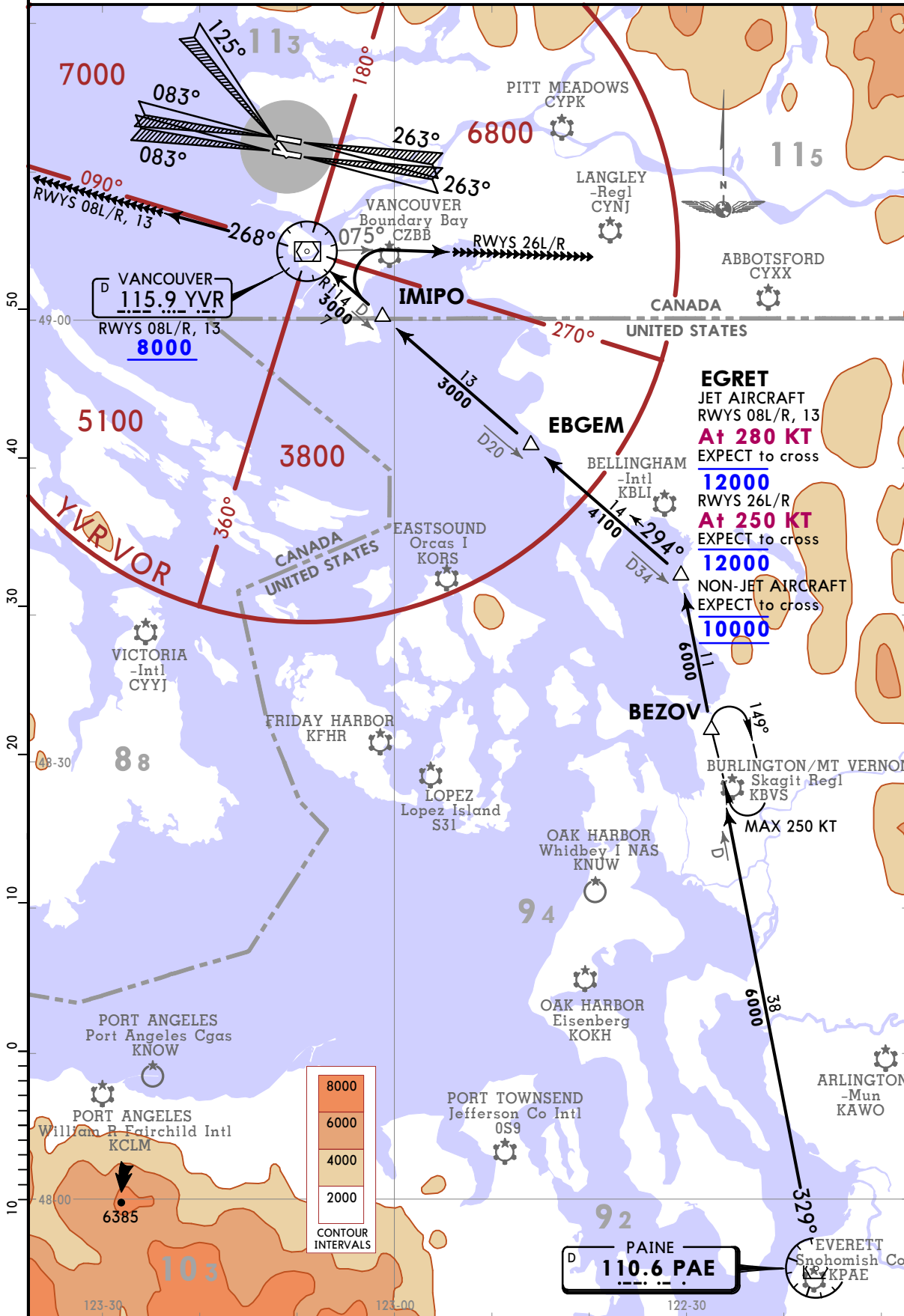

CHANGES: None.

© JEPPESEN, 2018, 2022. ALL RIGHTS RESERVED.

JEPPesen VANCOUVER, BC
 17 FEB 23 (10-2M) Eff 23 Feb RNAV STAR

D-ATIS 124.6 Apt Elev 13

Alt Set: INCHES Trans level: FL180
 1. Safe Altitude within 100 NM 12,800.
 2. RADAR required when CY(R)-107 active above 4000.

RAGIT 6 ARRIVAL
(FOCHE.RAGIT6)
(RWYS 08L/R, 13)

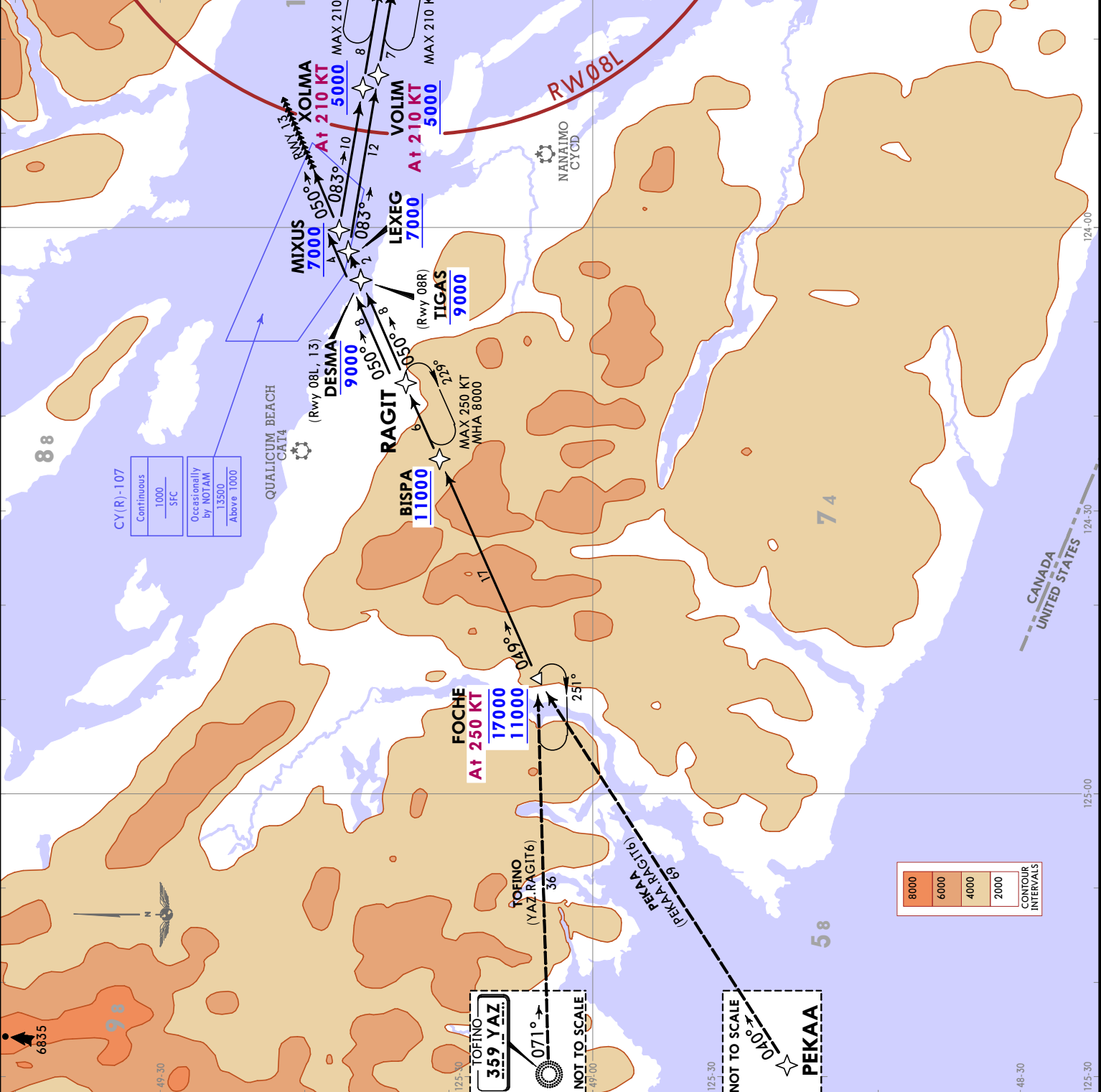

CYVR/YVR
VANCOUVER INTL

VANCOUVER, BC
RNAV STAR

JEPPesen
17 FEB 23 (10-2N) Eff 23 Feb

CYVR/YVR
VANCOUVER INTL

D-ATIS 124.6	Apt Elev 13	Alt Set: INCHES Trans level: FL180 Safe Altitude within 100 NM 12,800.
------------------------	-----------------------	--

**SHARK 2 ARRIVAL
(CASDY.SHARK2)
(RWYS 26L/R)**

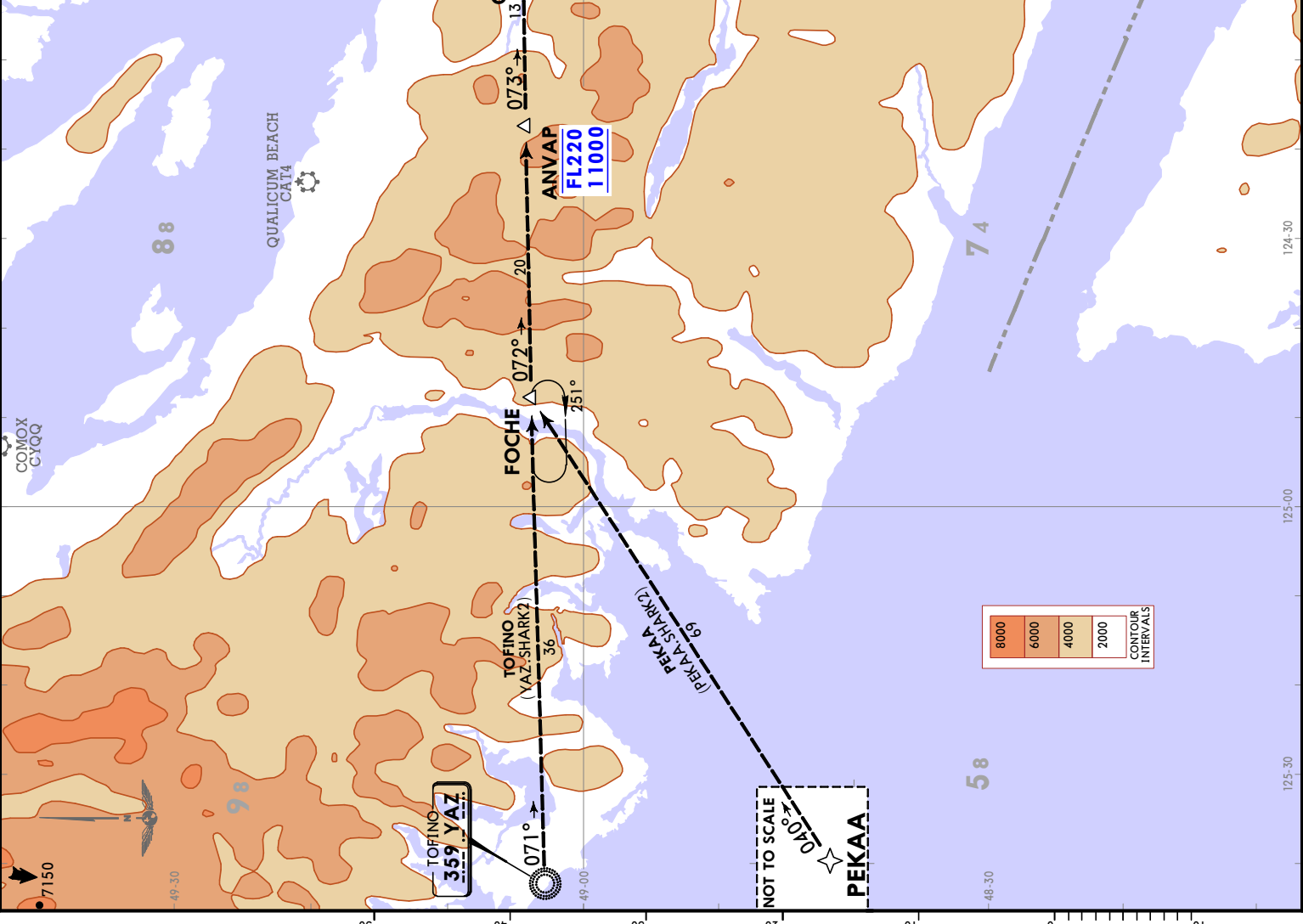

CYVR/YVR
VANCOUVER INTL

JEPPESEN
17 FEB 23 10-2P Eff 23 Feb

VANCOUVER, BC
RNAV STAR

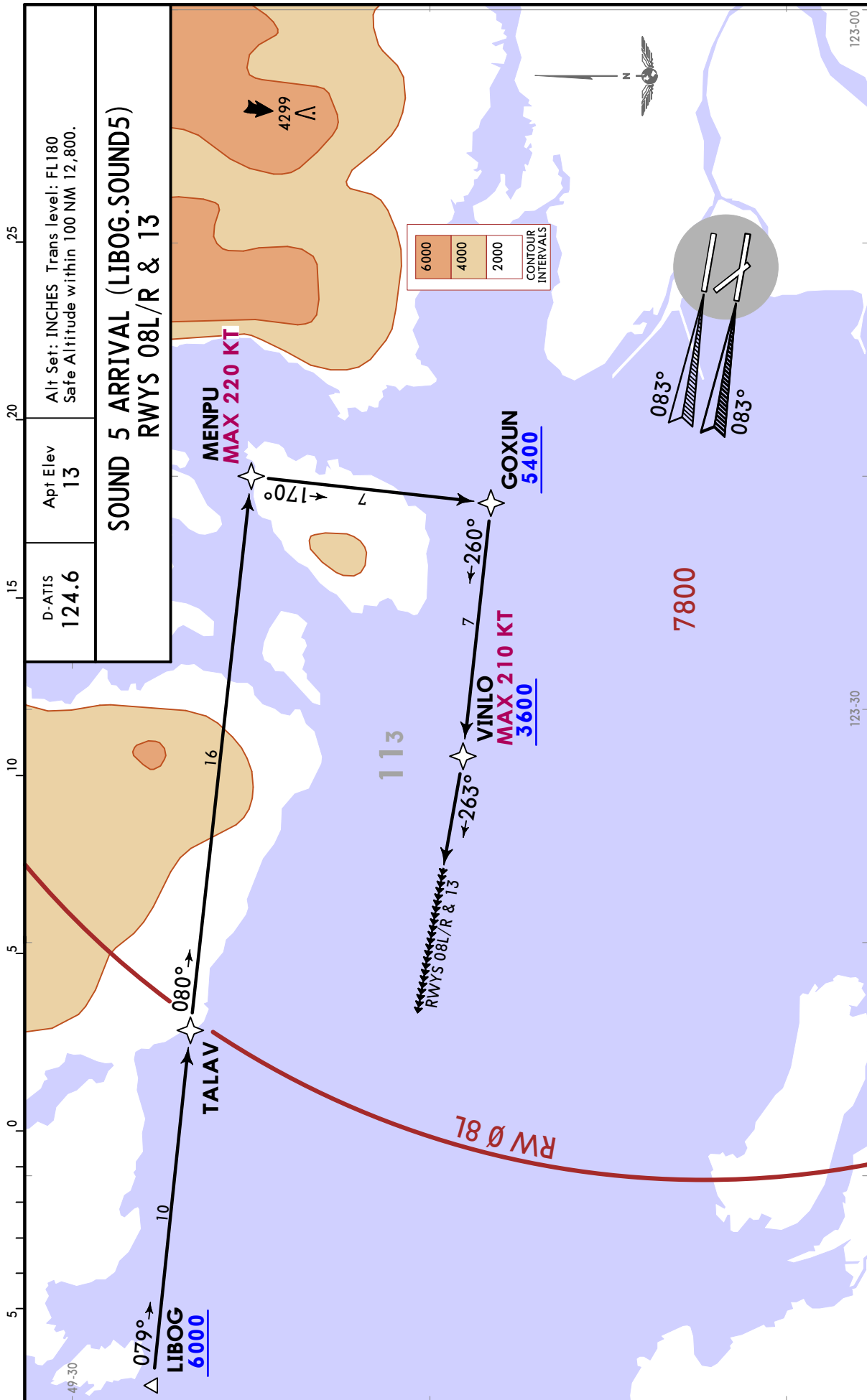

CHANGES: None.

© JEPPESEN, 2018, 2022. ALL RIGHTS RESERVED.

CYVR/YVR
VANCOUVER INTL

JEPPesen
17 FEB 23 10-2Q Eff 23 Feb

VANCOUVER, BC
RNAV STAR

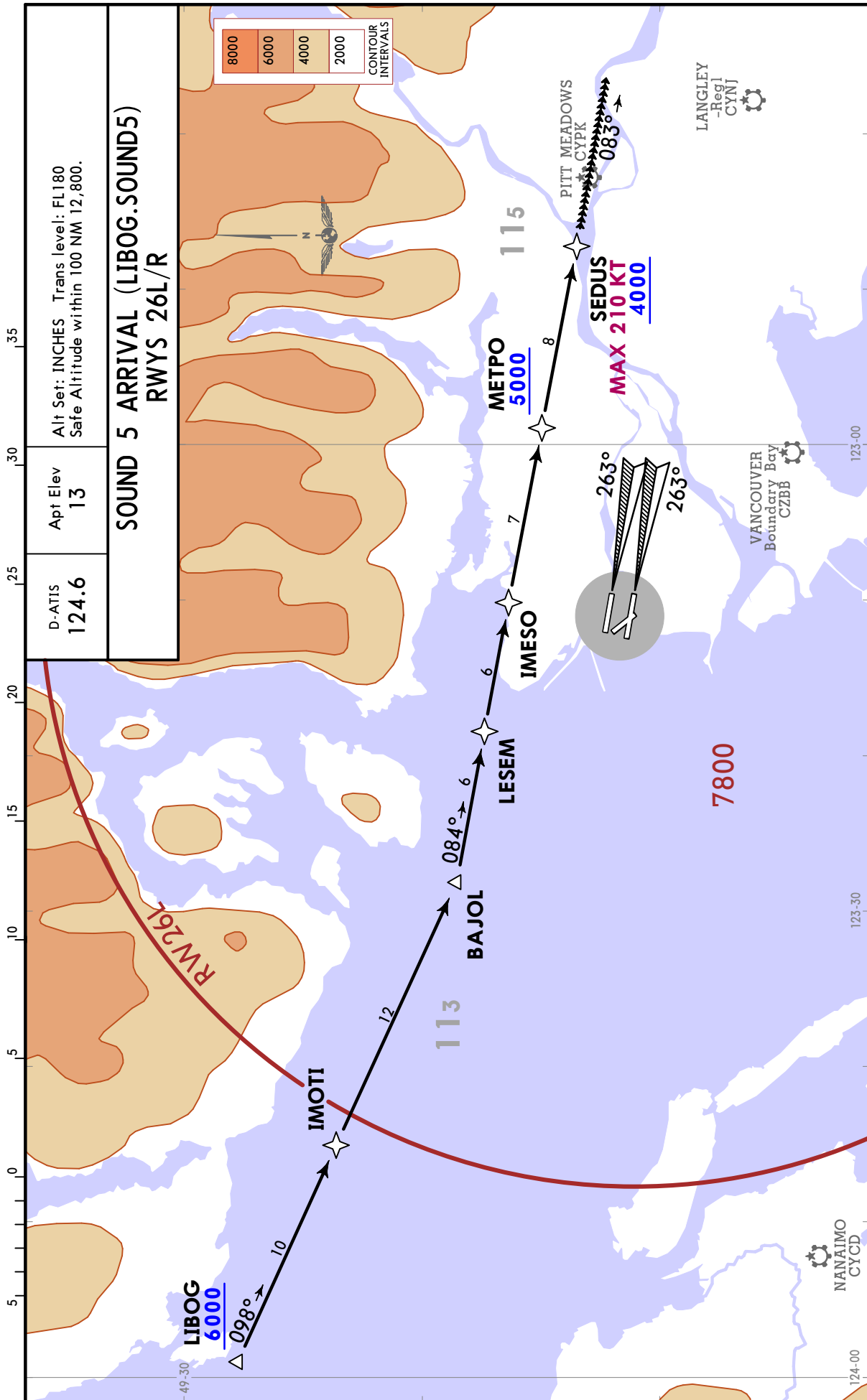

CYVR/YVR
VANCOUVER INTL

JEPPESEN
17 FEB 23 **10-25** Eff 23 Feb

VANCOUVER, BC
STAR

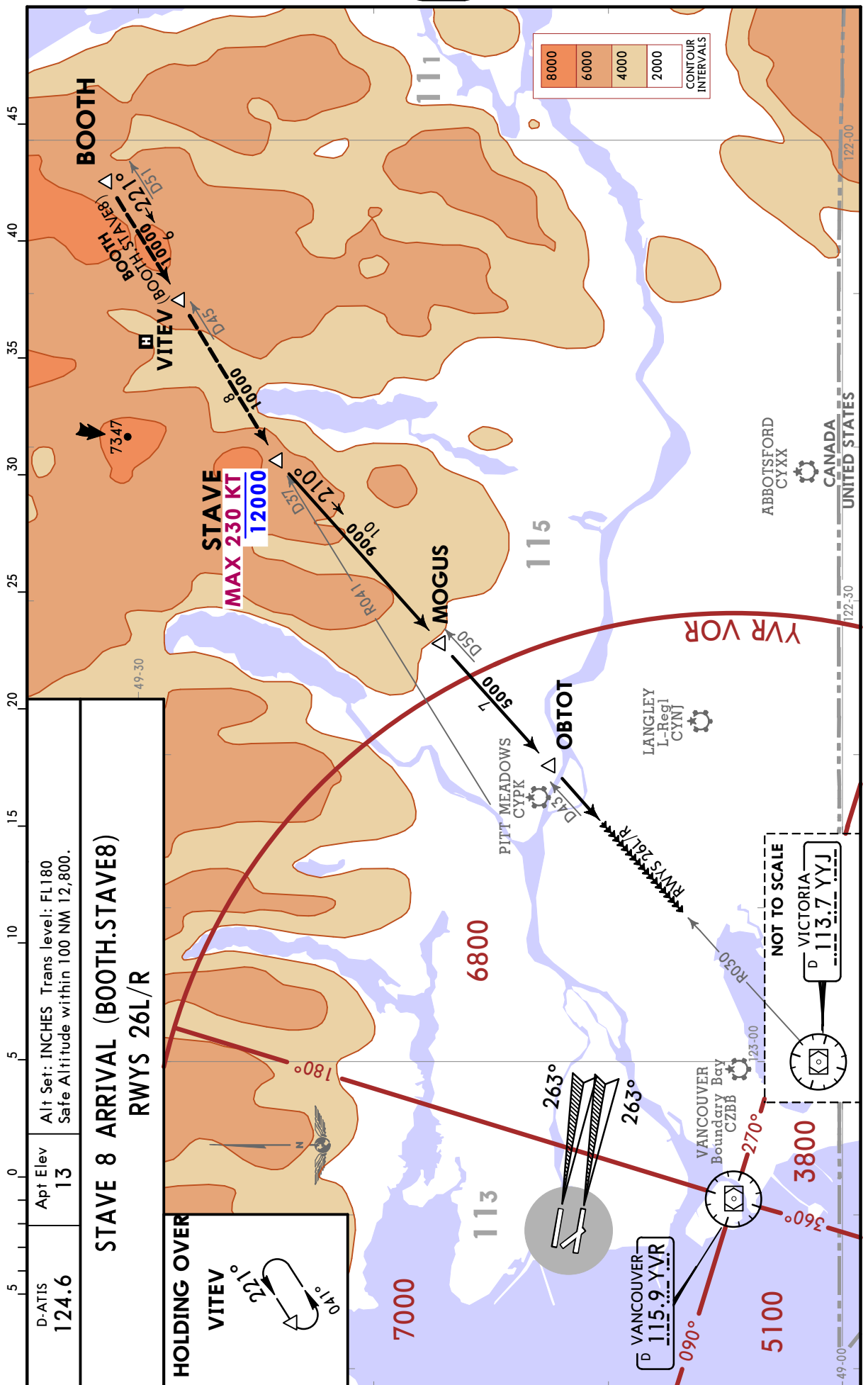

CHANGES: None.

© JEPPESEN, 2018, 2022. ALL RIGHTS RESERVED.

CYVR/YVR
VANCOUVER INTL

JEPPesen
17 FEB 23 10-2T Eff 23 Feb

VANCOUVER, BC
RNAV STAR

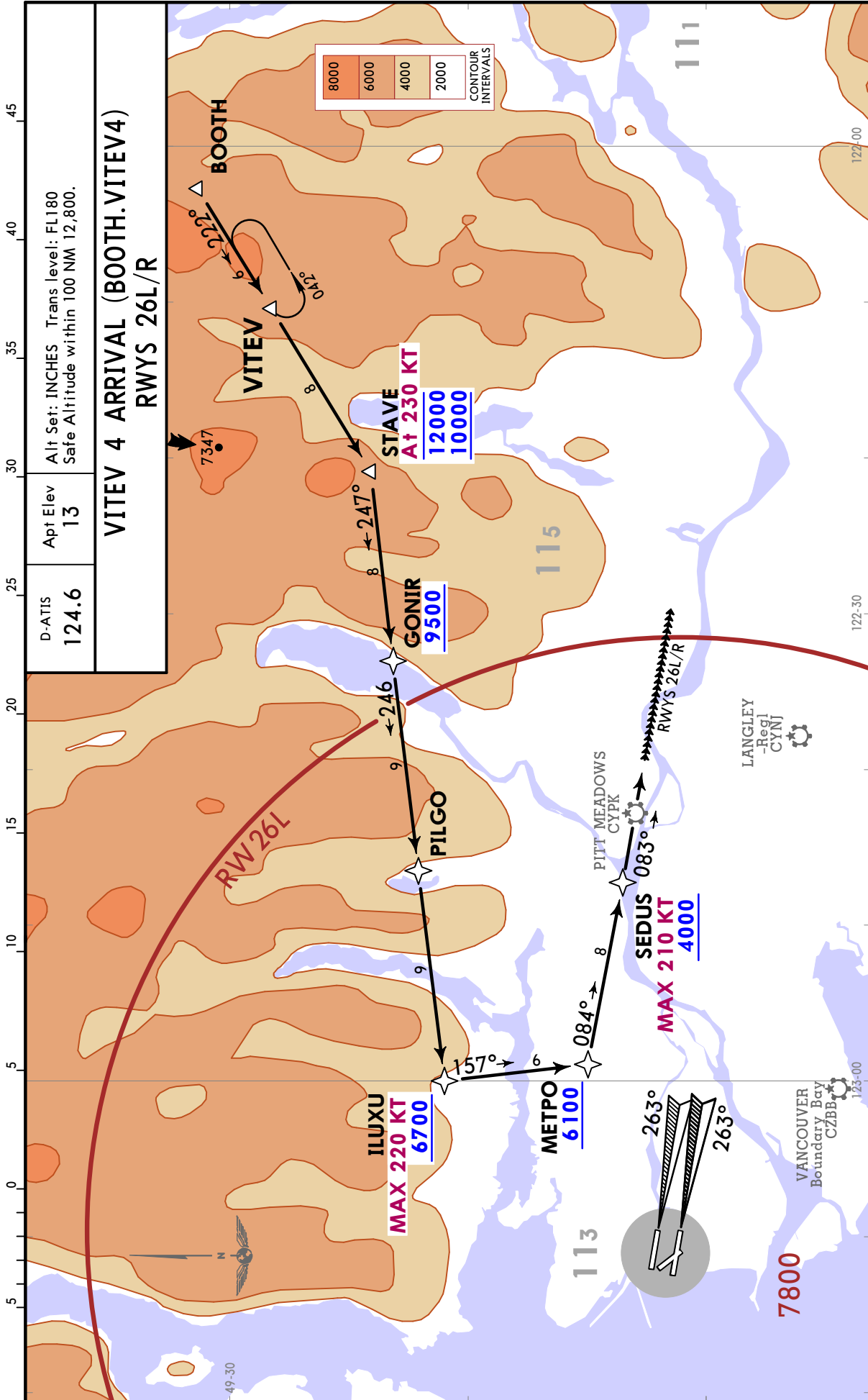

CHANGES: MSA revised.

© JEPPESEN, 2018, 2023. ALL RIGHTS RESERVED.

JEPPESEN
 17 FEB 23 (10-2V) **Eft 23 Feb**
RNAV STAR

CYVR/YVR
VANCOUVER INTL

VANCOUVER, BC

D-ATIS 124.6	Apt Elev 13	Alt Set: INCHES Safe Altitude within 100 NM 12,800.
WHISTLER 7 ARRIVAL (KEINN.WHSLR7)		
RWYS 26L/R		

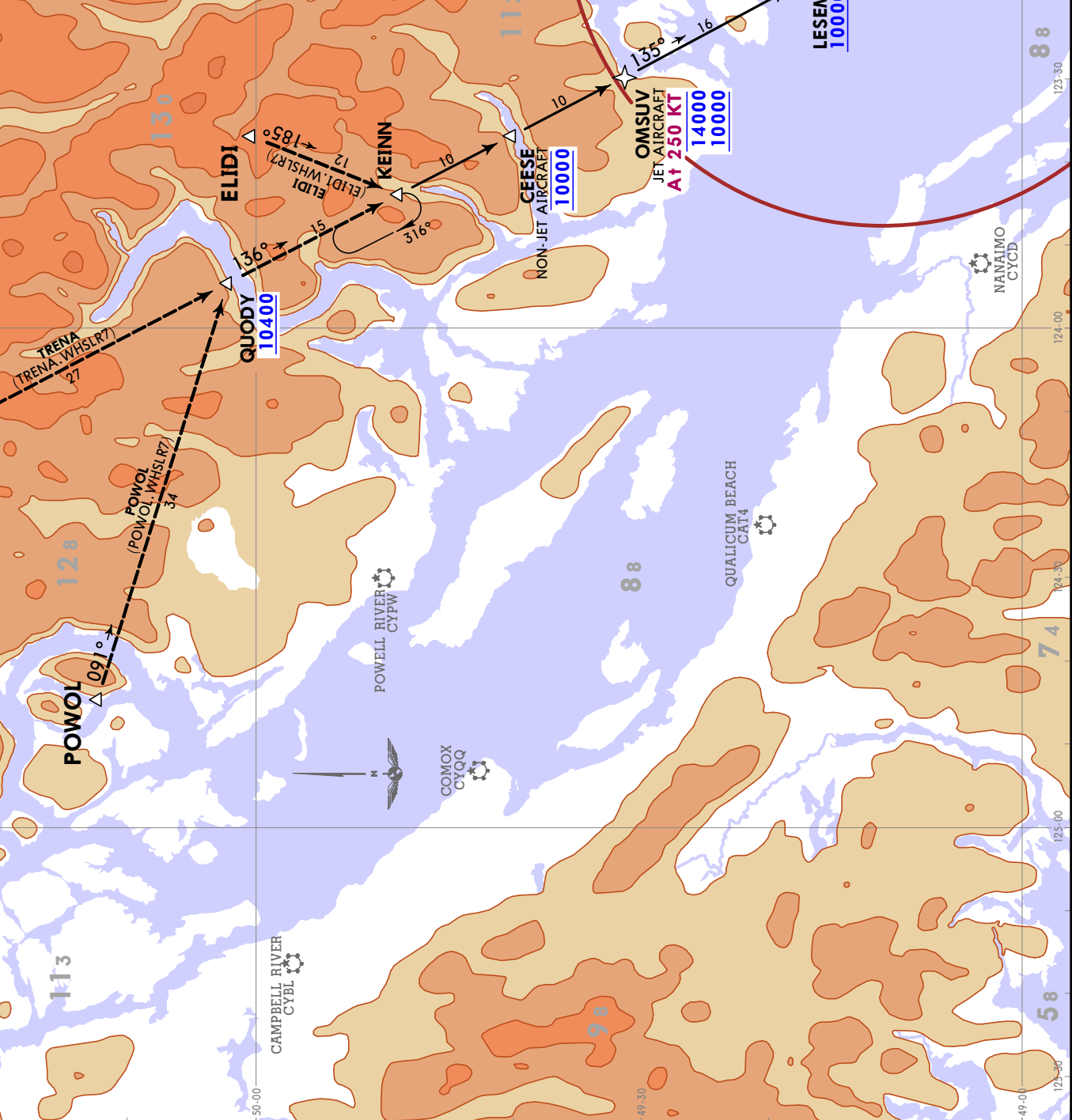

10000	8000	6000	4000	2000
CONTOUR INTERVALS				

CYVR/YVR
VANCOUVER INTL

JEPPESEN
2 SEP 22 **(10-3A)** Eff 8 Sep

VANCOUVER, BC
SID

VANCOUVER Departure		Apt Elev 13	Trans alt: 18000 1. CAUTION: Simultaneous parallel departures may be in use. 2. Safe Altitude within 100 NM 12,800. 3. Jet aircraft use Noise Abatement Departure Procedure 1 or 2. 4. Refer to 10-4 Noise Abatement Procedures for additional requirements.
NORTH	SOUTH		
126.12	132.3		

GEORGIA 6 DEPARTURE (GRG6.) (VECTOR)
(RWY 26L)

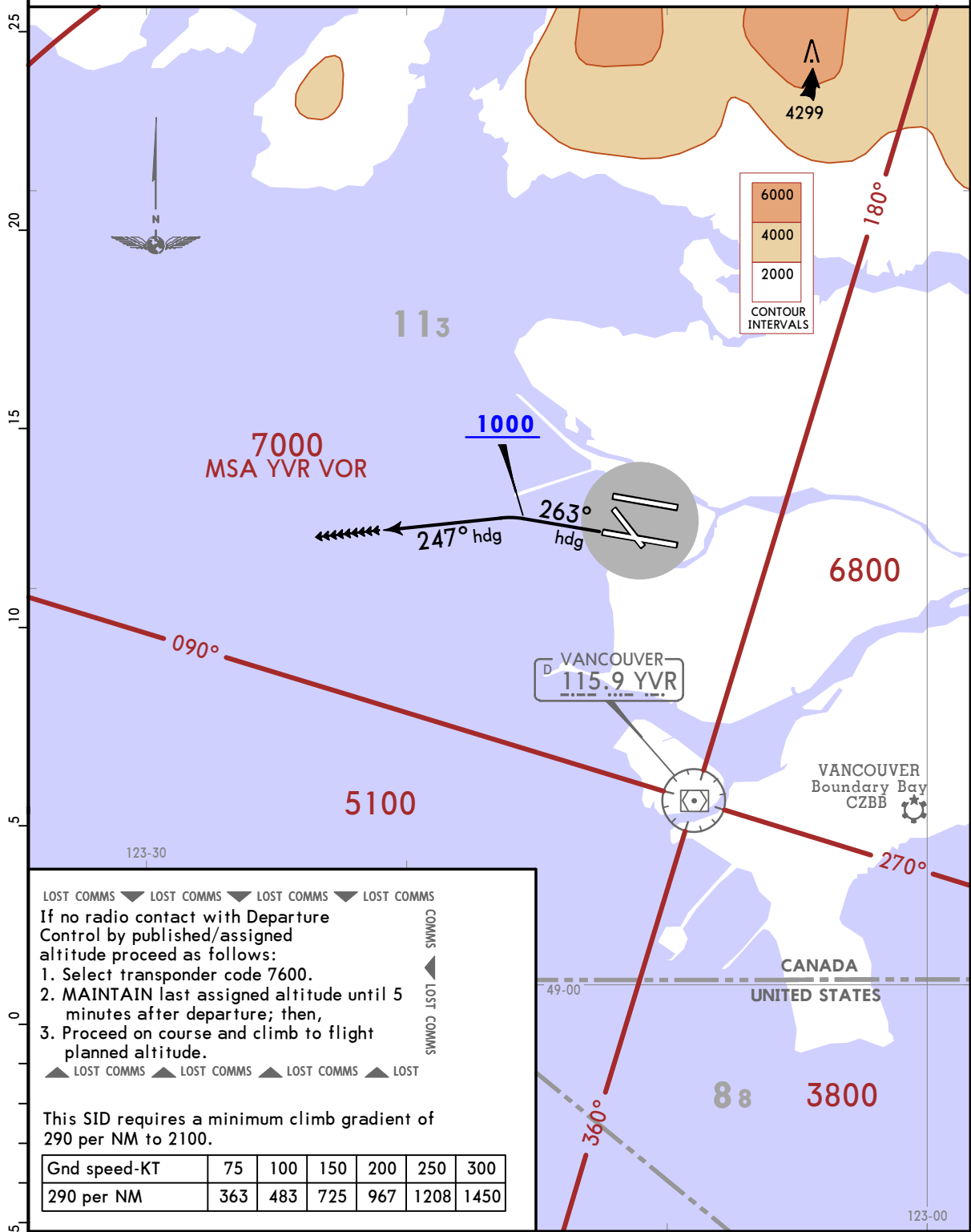

LOST COMMS ▼ LOST COMMS ▼ LOST COMMS ▼ LOST COMMS

If no radio contact with Departure Control by published/assigned altitude proceed as follows:

1. Select transponder code 7600.
2. MAINTAIN last assigned altitude until 5 minutes after departure; then,
3. Proceed on course and climb to flight planned altitude.

▲ LOST COMMS ▲ LOST COMMS ▲ LOST COMMS ▲ LOST

COMMIS ▲ LOST COMMS

This SID requires a minimum climb gradient of 290 per NM to 2100.

Gnd speed-KT	75	100	150	200	250	300
290 per NM	363	483	725	967	1208	1450

INITIAL CLIMB

Climb heading 263° to 1000. Then climbing LEFT turn heading 247° or as assigned by ATC. MAINTAIN 7000 or as assigned. EXPECT RADAR vectors to filed/assigned route or depicted fix and clearance to flight planned altitude/flight level 5 minutes after departure.

CYVR/YVR
VANCOUVER INTL

JEPPESEN
2 SEP 22 **(10-3B)** Eff 8 Sep

VANCOUVER, BC
SID

VANCOUVER Departure (SOUTH) 132.3	Apt Elev 13	Trans alt: 18000 1. Safe altitude within 100 NM 12,800. 2. Non-Jet aircraft only. 3. Refer to 10-4 Noise Abatement Procedures for additional requirements.
---	-----------------------	---

RICHMOND 7 DEPARTURE (RICHM7.) (VECTOR)
(RWY 26L)

SPEED: DO NOT EXCEED 165 KT IN CLIMB UNTIL IN CONTACT WITH DEPARTURE CONTROL AND PASSING 4000



LOST COMMS ▼ LOST COMMS ▼ LOST COMMS ▼ LOST COMMS ▼ LOST COMMS ▼ LOST COMMS

If no radio contact with Departure Control by published/assigned altitude, proceed as follows:

1. Select transponder code 7600.
2. MAINTAIN last assigned altitude and turn direct to YVR VOR. Hold inbound R-260.
3. Proceed on course 5 minutes after selecting code 7600 and climb to flight planned altitude.

LOST COMMS ▲ LOST COMMS ▲ LOST COMMS ▲ LOST COMMS ▲ LOST COMMS ▲ LOST COMMS

This SID requires a minimum climb gradient of:
290 per NM to 2000.

Gnd speed-KT	75	100	150	200	250	300
290 per NM	363	483	725	967	1208	1450

INITIAL CLIMB

Climb heading 263° to 500. Then climbing LEFT turn heading 200° or as assigned by ATC. Contact Departure Control after passing 1000 unless instructed otherwise by ATC. MAINTAIN 2000 or as assigned. EXPECT RADAR vectors to filed/assigned route or depicted fix and clearance to flight planned altitude/flight level 10 minutes after departure.

CYVR/YVR
VANCOUVER INTL

JEPPesen
2 SEP 22 **10-3C** Eff 8 Sep

VANCOUVER, BC
SID

VANCOUVER Departure (SOUTH) 132.3	Apt Elev 13	Trans alt: 18000 1. Safe altitude within 100 NM 12,800. 2. Non-Jet aircraft only. 3. Refer to 10-4 Noise Abatement Procedures for additional requirements.
---	-----------------------	---

STANLEY 5 DEPARTURE (STNLE5.)
(VECTOR)
(RWYS 08L/R)

SPEED: DO NOT EXCEED 165 KT IN CLIMB UNTIL IN CONTACT WITH DEPARTURE CONTROL AND PASSING 4000

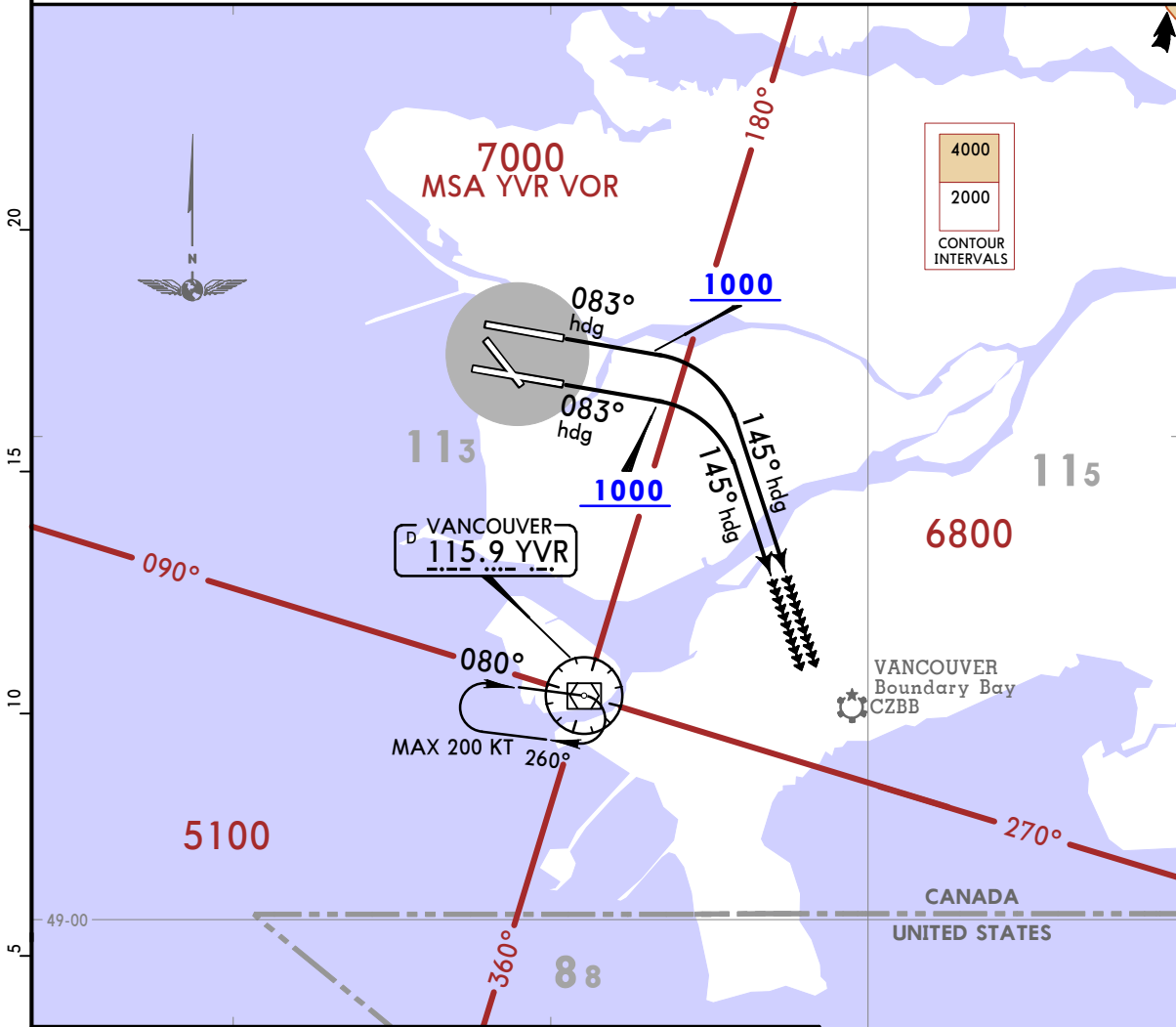

This SID requires a minimum climb gradient of:
Rwy 08L: 280 FT/NM to 500.

Gnd speed-KT	75	100	150	200	250	300
280 FT/NM	350	467	700	933	1167	1400

LOST COMMS ▼ LOST COMMS ▼ LOST COMMS ▼ LOST COMMS ▼ LOST COMMS ▼ LOST COMMS

If no radio contact with Departure Control by published/assigned altitude, proceed as follows:
All Rws:
1. Select transponder code 7600.
2. MAINTAIN last assigned altitude and turn direct to YVR VOR. Hold inbound R-260.
3. Proceed on course 5 minutes after selecting code 7600 and climb to flight planned altitude.

LOST COMMS ▲ LOST COMMS ▲ LOST COMMS ▲ LOST COMMS ▲ LOST COMMS ▲ LOST COMMS

INITIAL CLIMB

Climb heading 083° to 1000. Then climbing RIGHT turn heading 145° or as assigned by ATC. MAINTAIN 2000 or as assigned. EXPECT RADAR vectors to filed/assigned route and clearance to flight planned altitude/flight level 10 minutes after departure.

CYVR/YVR
VANCOUVER INTL

JEPPESEN
2 SEP 22 **(10-3D)** Eff 8 Sep

VANCOUVER, BC
SID

VANCOUVER Departure		Apt Elev 13	Trans alt: 18000 1. Safe altitude within 100 NM 12,800. 2. Non-Jet aircraft do not exceed 165 KT in climb until in contact with Departure Control and passing 4000. 3. Jet aircraft use Noise Abatement Departure Procedure 1 or 2. 4. Refer to 10-4 Noise Abatement Procedures for additional requirements.
NORTH	SOUTH		
126.125	132.3		

VANCOUVER 2 DEPARTURE (YVR2.)
(VECTOR)
(ALL RWYS)

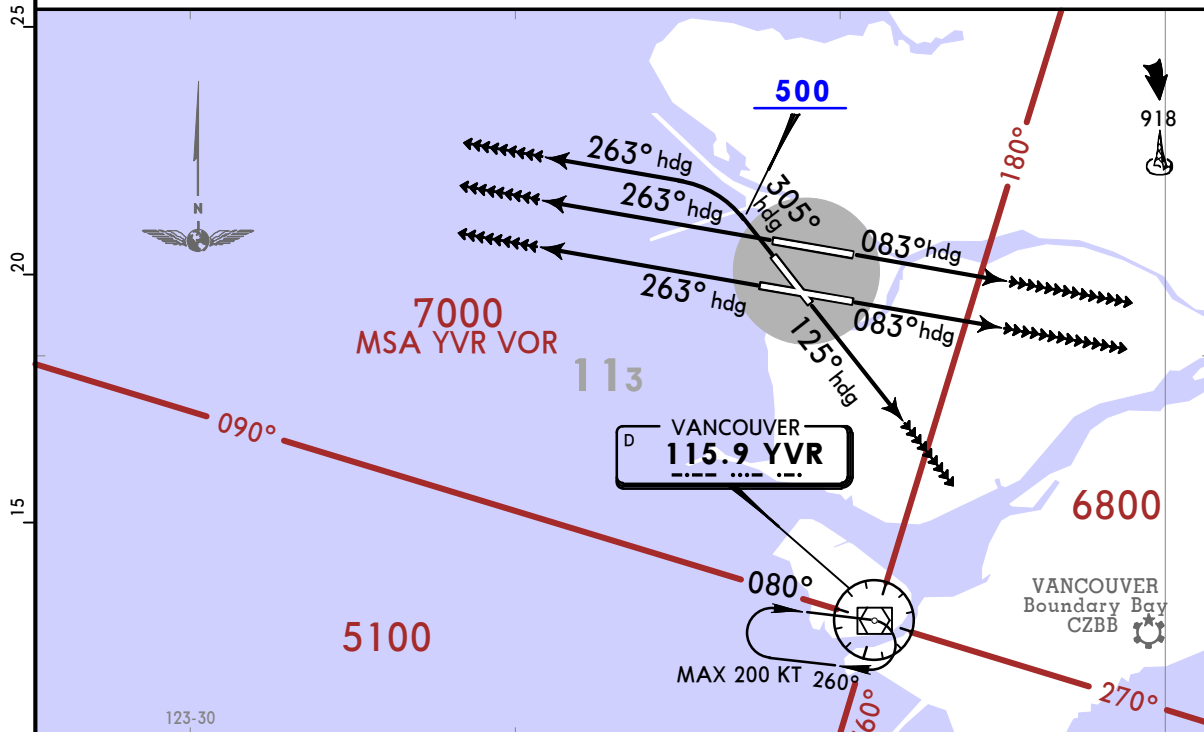

This SID requires a minimum climb gradients of:
Rwy 08L: 280 FT/NM to 500.
Rwys 26L/R: 290 FT/NM to 2100.

Gnd speed-KT	75	100	150	200	250	300
280 FT/NM	350	467	700	933	1167	1400
290 FT/NM	363	483	725	967	1208	1450

LOST COMMS ▼ LOST COMMS ▼ LOST COMMS ▼ LOST COMMS ▼ LOST COMMS ▼ LOST COMMS ▼

On recognition of failure 5 minutes or less after take-off, below 7000 and in IFR weather conditions, proceed as follows:
Rwys 08L/R:
1. Select transponder code 7600.
2. Beyond D10.0 of YVR VOR MAINTAIN last assigned altitude, RIGHT turn direct to YVR VOR. Hold inbound R-260.
3. Proceed on course 5 minutes after selecting 7600 and climb to flight planned altitude.
Rwys 13, 26L/R, 31:
1. Select transponder code 7600.
2. Proceed on course 5 minutes after selecting 7600 and climb to flight planned altitude.
If communication failure occurs more than 5 minutes after take-off, comply with appropriate procedures for communication failure enroute.

RWY	INITIAL CLIMB
08L/R	Climb heading 083° or as assigned by ATC.
13	Climb heading 125° or as assigned by ATC. NOTE: Building to 50 approximately 0.15 NM past DER, 685 LEFT of runway centerline. Tower to 50 approximately 0.2 NM past DER, 500 LEFT of runway centerline.
26L/R	Climb heading 263° or as assigned by ATC.
31	Climb heading 305° to 500. Then climbing LEFT turn heading 263° or as assigned by ATC.

ROUTING
MAINTAIN 7000 or as assigned. EXPECT RADAR vectors to filed/assigned route and clearance to flight planned altitude/flight level 5 minutes after departure.

CYVR/YVR



VANCOUVER, BC
VANCOUVER INTL

NOISE ABATEMENT PROCEDURES

APPLICATION

These procedures apply to JET AIRCRAFT unless noted otherwise.

DEPARTURE PROCEDURES

JET AIRCRAFT

1. Noise Abatement Departure Procedure 1 or 2 required for all runways. See Jeppesen Canada ATC para 7.6. Advise ATC CLNC DEL if using Noise Abatement Departure Procedure 1. Follow SID to 3000' before proceeding on course.
2. Rwy 08R between 2300-0600 local time; aircraft on westerly routes follow assigned SID to 2000' before proceeding on course.
3. ICAO Annex 16 Chapter 2 or FAA FAR Part 36 Stage 2 certified aircraft; departures on Rwys 08L and 26R not permitted.

ARRIVAL PROCEDURES

IFR APPROACHES & PUBLISHED VISUAL APPROACHES

Use low power/drag profiles consistent with safe operating procedures, conforming to published visual approaches and as directed by ATC.

VFR APPROACHES

Conform to published VTA routes and as directed by ATC.

REVERSE THRUST - LANDING

All Rwys: Use of reverse thrust is to be avoided or reduced when conditions permit.

NIGHT RESTRICTIONS	
LOCAL TIME	Procedure
1. 0001-0600	Departure of ICAO Annex 16 Chapter 2 or FAA FAR Part 36 Stage 2 certified JET AIRCRAFT 34,000 kg (74,957 lbs) and over <u>not permitted.</u>
2. 0001-0600	Departure of JET AIRCRAFT rated over 34,000 kg (74,957 lbs) (MTOW), regardless of actual take-off weight, require prior approval from YVR AA OPERATIONS.
3. 2200-0700	Departure/Arrival of ALL AIRCRAFT on Rwys 08L & 26R <u>not permitted.*</u>
4. 2200-0700	Local training flights <u>not permitted.</u>

* See CONTACT and APPROVALS Section.

ALL AIRCRAFT (PRIORITY FLIGHTS EXEMPT)	
LOCAL TIME	Preferential Runway Usage
1. 0600-2300	Defer to westerly flow.
One direction flow	Minimize departures on runway 13 and arrivals on runway 31.
2. 2300-0600	Westerly flow for departures and easterly flow for arrivals.
Two direction flow	Minimize departures on runway 13 and arrivals on runway 31.
Subject to limiting factors including: physical condition of surfaces; irregular airfield operations; crosswind and tailwind conditions: and, traffic volume. (MEDEVACS EXEMPT).	

IT IS THE PILOT'S RESPONSIBILITY TO ADHERE TO PUBLISHED NOISE ABATEMENT PROCEDURES.

CYVR/YVR



VANCOUVER, BC
VANCOUVER INTL

NOISE ABATEMENT PROCEDURES

ENGINE RUN-UP RESTRICTIONS

Maintenance engine run-ups for ALL AIRCRAFT require prior approval from YVRAA OPERATIONS. Guidelines are contained in the Airport Operations Directive, Aircraft Engine Run-ups.

ALTITUDE RESTRICTIONS

1. Exclusive of the Departure and Arrival procedures, no departing or arriving aircraft shall operate over the City at less than 5000' MSL (8000' between 2300 - 0700 local time- except aircraft operating on published RNAV STAR).
2. The City is defined as that area lying between the South Arm of the Fraser River and the North Shore of Burrard Inlet and from Point Gray to the eastern boundary of the Vancouver Control Zone.

CONTACT and APPROVALS

Night Restrictions #3: YVRAA OPERATIONS may permit exemptions for emergencies and airfield maintenance. **Tel: 604-207-7022; Fax: 604-276-6099 (24 hours)**

IT IS THE PILOT'S RESPONSIBILITY TO ADHERE TO PUBLISHED NOISE ABATEMENT PROCEDURES.

CYVR/YVR



TAXI
VANCOUVER, BC
VANCOUVER INTL
 Standard Taxi Procedures

CODED TAXI ROUTES

READ BACK: "CODE ROUTE (name) AND ASSIGNED RUNWAY"

Monitor tower frequency approaching the hold line of the assigned runway, unless otherwise instructed by ATC.

Rwy 08R/26L - Tower 118.7

Rwy 08L/26R - Tower 119.55

CODE	TAXI ROUTE
Echo	Rwy 08R - E, D, H, hold short L. Rwy 08L - E, D, H, hold short V, contact Ground 127.15 (expect taxi via H, M, M10). Rwy 26R - E, D, H, hold short V, contact Ground 127.15 (expect taxi via V, M, M9). Rwy 26L - E, D.
Golf	Rwy 08R - G, H, hold short L. Rwy 08L - G, H, hold short V, contact Ground 127.15 (expect taxi via H, M, M10). Rwy 26R - G, H, hold short V, contact Ground 127.15 (expect taxi via V, M, M9). Rwy 26L - G, H, D.
① Juliet-Alpha	Rwy 08R - JA, J, K, V, hold short H, contact Ground 121.7 (expect taxi via V, L). Rwy 08L - JA, J, M, M10. Rwy 26R - JA, J, M, M9. Rwy 26L - JA, J, K, V, hold short H, contact Ground 121.7 (expect taxi via H, D).
① Juliet-Bravo	Rwy 08R - JB, J, K, V, hold short H, contact Ground 121.7 (expect taxi via V, L). Rwy 08L - JB, J, M, M10. Rwy 26R - JB, J, M, M9. Rwy 26L - JB, J, K, V, hold short H, contact Ground 121.7 (expect taxi via H, D).
① Juliet-Charlie	Rwy 08R - JC, K, V, hold short H, contact Ground 121.7 (expect taxi via V, L). Rwy 08L - JC, J, M, M10. Rwy 26R - JC, J, M, M9. Rwy 26L - JC, K, V, hold short H, contact Ground 121.7 (expect taxi via H, D).
Lima	Rwy 08L - L, H, hold short V, contact Ground 127.15 (expect taxi via H, M, M10). Rwy 26R - L, H, hold short V, contact Ground 127.15 (expect taxi via V, M, M9). Rwy 26L - L, J, H, D.
① Papa	Rwy 08R - P, M, V, hold short H, contact Ground 121.7 (expect taxi via V, L). Rwy 08L - P, M, M10. Rwy 26R - P, M, M9. Rwy 26L - P, M, V, hold short H, contact Ground 121.7 (expect taxi via H, D).
Sierra	Rwy 08R - S, M, V, hold short H, contact Ground 121.7 (expect taxi via V, L). Rwy 08L - S, M, M10. Rwy 26R - S, M, M9. Rwy 26L - S, M, V, hold short H, contact Ground 121.7 (expect taxi via H, D).
① Tango	Rwy 08R - T, M, V, hold short H, contact Ground 121.7 (expect taxi via V, L). Rwy 08L - T, M, M10. Rwy 26R - T, M, M9. Rwy 26L - T, M, V, hold short H, contact Ground 121.7 (expect taxi via H, D).

① Taxi routes for A340-600/B777-300/A350-900/A350-1000.

**2023 SUMMER CONSTRUCTION AT CYVR:
TAXIWAYS L, L2, L4 AND D3 REHABILITATION
AND IMPROVEMENTS (SUP 15/23)**

Introduction

From late March to Mid-December 2023, Vancouver International Airport (CYVR) will be conducting multiple airfield construction projects, impacting several surfaces on the south airfield. The following projects will take place between Late March 2023 to Late October 2023:

- Taxiway L Rehabilitation
- Taxiway L2 Improvements
- Taxiway L4 Improvements
- Taxiway D3 Improvements

Since all activities are subject to operational requirements and construction schedules, actual dates and times of surface closures relating to construction activities will be promulgated through briefing documents and NOTAM.

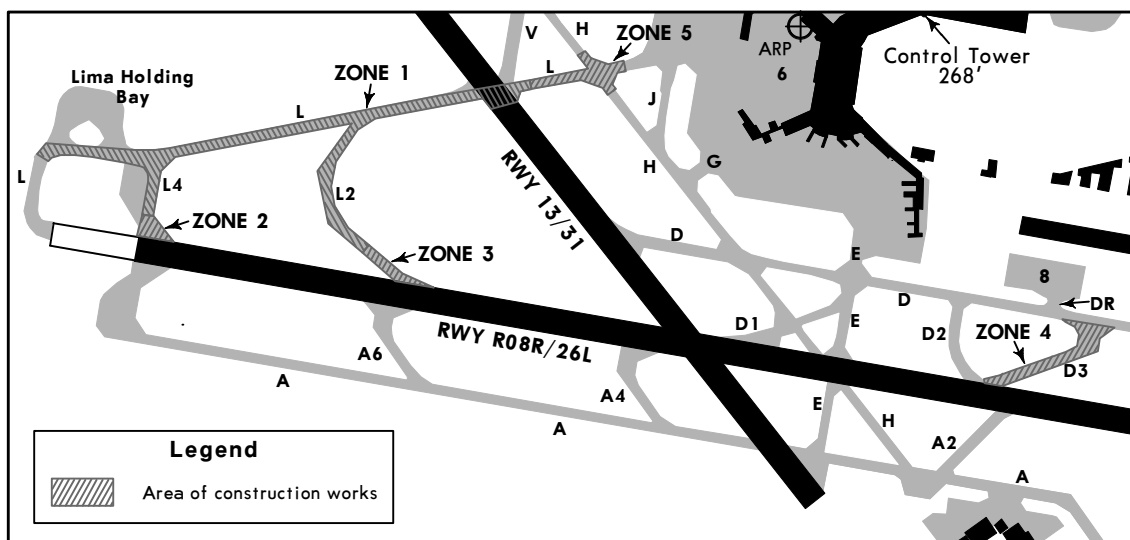

Figure 1: Work Zones

General Airfield Impacts During Construction

Date	Facility	Impact	Work Zone(s)
Late March - Late June	Twy L and Rwy 13/31 Intersection	CLOSED Daytime Work	Zone 1
Late March - Late July	Twy L between Rwy 13/31 and Twy L4	CLOSED Daytime Work	Zone 1
Late March - Late July	Twy L between Twy L4 and 08R Holding Position	CLOSED Daytime Work	Zone 1
Early July - Late July	Twy L between Twy J and Rwy 13/31	CLOSED Nighttime Work	Zone 5
Late March - Late October	Twy L2 within Rwy 08R/26L Strip	CLOSED Nighttime Work	Zone 3
	Twy L2 outside Rwy 08R/26L Strip	CLOSED Daytime Work	Zone 1
Late March - Late July	Twy L4 within Rwy 08R/26L Strip	CLOSED Nighttime Work	Zone 2
	Twy L4 outside Rwy 08R/26L Strip	CLOSED Daytime Work	Zone 1
Early July - Late October	Twy D3	CLOSED Nighttime Work	Zone 4

Details of any procedure or level of service changes implemented due to this construction activity will be promulgated via NOTAM.

RWY	LANDING BEYOND		USABLE LENGTHS	
	Threshold	Glide Slope	TAKE-OFF	WIDTH
08R	HIRL CL ALSF-II TDZ ② PAPI-L (angle 3.0°)	RVR	9640' 2938m 11,500' 3505m	200' 61m
② For aircraft with eye-to-wheel height up to 45'.				
08L	HIRL CL ALSF-II TDZ ⑤ PAPI-L (angle 3.0°)	RVR	8887' 2709m 8935' 2723m	200' 61m
⑤ For aircraft with eye-to-wheel height up to 45'.				
13	MIRL ODALS ④ PAPI-L (angle 3.0°)		6193' 1888m	200' 61m
④ For aircraft with eye-to-wheel height up to 45'.				

RUNWAY INCURSION HOT SPOTS

For information only, not to be construed as ATC instructions.

HS 1 Twy V holdline for Rwy 13/31 is 100' (30m) back due to intersection geometry.

HS 2 Aircraft taxiing H, southbound, holdline is located 100' (30m) back from the standard runway hold position. Aircraft exiting onto Twy D1, turn North on Twy E. Do not stop in runway area.

HS 3 Twy N7 hold line for Rwy 26R/08L at intersection Twy N7 and Apron IX.

HS 4 Aircraft cannot safely taxi via Twy D East or West past aircraft at the Twy D5 or Twy D7 hold lines. Twy D9 commences beyond the runway holdshort line for Rwy 08R/26L on Twy D and Twy DY.

HS 5 Multiple taxilanes converge.

HS 6 Taxiing to Rwy 08R/26L, aircraft fail to hold short and incur on Rwy 13/31 on Twy A.

HS 7 Taxiing across Rwy 08R/26L, aircraft fail to hold short and incur on Rwy 13/31 on Twy E.

TAKE-OFF & DEPARTURE PROCEDURE	
For departure procedure see Vancouver SID	
Rwys 08L/R, 26L/R	
Authorized Air Carriers	
HIRL & CL & RCLM	HIRL or CL or RCLM
TDZ RVR 6 Rollout or Mid RVR 6	RVR 26 or 1/2
① RVR 10 required for start.	

GENERAL

CAUTION: October - April migratory birds in vicinity of airport: Resident snow goose population, significant hazard at and below 400' AGL West of the threshold of Rwy 08R and Rwy 08L out to 1.9 NM.

CAUTION: Frequent VFR float aircraft activity on river south side of airport.

CAUTION: ALL JET AIRCRAFT: Light aircraft susceptible to jetblast when turning from twy F on to C.

Multilateration: Pilots must keep their transponder on at all times when maneuvering on the airport (turned on prior to brake release and on arrival, on until final engine shutdown). Pilots that do not have transponder code issued by ATC squawk 1000 when taxiing.

Rwy Arrivals & Departures:

Rwy 08L arrivals:
Use of reverse thrust is to be avoided or reduced when conditions permit.
Rwy 08R arrivals: Aircraft exiting onto Twy D1, turn North on Twy E. Do not stop in twy area. See HOT SPOT 2.

Rwy 26R arrivals:
Use of reverse thrust is to be avoided or reduced when conditions permit.

Rwy 26L arrivals: Turns onto Rwy 31 NOT AUTHORIZED without clearance. Aircraft exiting onto Rwy 13/31: Right hand turns onto Twy D restricted to B767/A310 & smaller, discretionary oversteer is required. Aircraft exiting onto Twy H, hold short of Twy D. Do not stop in rwy area. See HOT SPOT 2.

Rwy 13 departures: Not Authorized for A340-600/B777-300/A350-900/A350-1000/B787-10 and larger.

Rwy 31 departures: Not Authorized for A340-600/B777-300/A350-900/A350-1000/B787-10 and larger.

UNCONTROLLED VEHICLES CROSSINGS

Twys DS, DT, DU, DV, DY, F, H (north of H4), J, JA, JB, JC, K, N7, P, Q, R, S, T, V.

APU SHUTDOWN PROCEDURE

Aircraft Auxiliary Power Unit (APU) use shall be limited to 15 minutes or less in total between on-block time and departure of aircraft from stands supplied with Ground Power Unit (GPU) and/or preconditioned air, for environmental reasons, if the outside air temperature is between 0 degrees and 20 degrees Celsius.

Aircraft shall not need to comply with the above limitations on stands not equipped with serviceable GPU and/or preconditioned air or if there are overriding health & safety considerations.

APRON

Advise ATC if ground crew not present at gate.

Apron 1: Restricted to CRJ-900/SF34 and smaller.

Apron 3: Jets towed in and out.

Apron 4: Restricted to B757 and smaller. Aircraft stand taxilane east of DW restricted to Convair CV-580 and smaller.

Apron 1, 2, 3, 4, 5, 6, 8: Prior permission required Airport Operations.

Apron 6 (East): bypass (taxilane centerline amber lighting): Simultaneous use of dual taxilanes restricted to narrow body aircraft. Restricted to B737 and smaller.

Apron 6 (East): Pushbacks from remote parking positions E1-E3 to west taxilane.

Apron 6 (East): Pushbacks from remote parking positions E10-E19 to south taxilane.

Apron 6 (horseshoe): Taxilanes restricted to B737/A321 and smaller.

Apron 6: Traveling eastbound, turns onto P restricted to B767/A310 and smaller.

Apron 6: All aircraft use minimum thrust due to jet blast.

Prior permission required from YVR OPS for all engine airstarts or crossbleed starts on Aprons 1, 2, 3, 4, 5, 6, 8.

Apron 8: Restricted to B767/A310 and smaller.

WIDE BODY AIRCRAFT

A380 ①/B747-8/AN124 Available Twys: D, DT, D3, D5, D7, D9, H (north of Rwy 08R/26L), J (north of parking position W2), JA, K (west of R), L (west of 13/31), M, M5, M6, M7, M9, M10, P, R, V. Discretionary oversteer is required at every intersection.

A340-600/B777-300/A350-900/A350-1000/B787-10 Available Twys: D, D3, D5, D7, D9, DT, DY, E (south of Rwy 08R/26L), H (north of Rwy 08R/26L), J, JA, JB, JC, K, L (west of J), M, M4, M5, M6, M7, M8, M9, M10, P, R, V. Discretionary oversteer is required at every intersection.

Departing A340-600/B777-300 use the following coded taxi routes ONLY:

- Juliet - Alpha
- Juliet - Bravo
- Juliet - Charlie
- Juliet - Papa
- Juliet - Tango

① A380: When A380 is on Twy M between Twy J and Twy T, the taxilane between Gate 66 & Twy T is restricted to B757 & smaller (& vice versa).

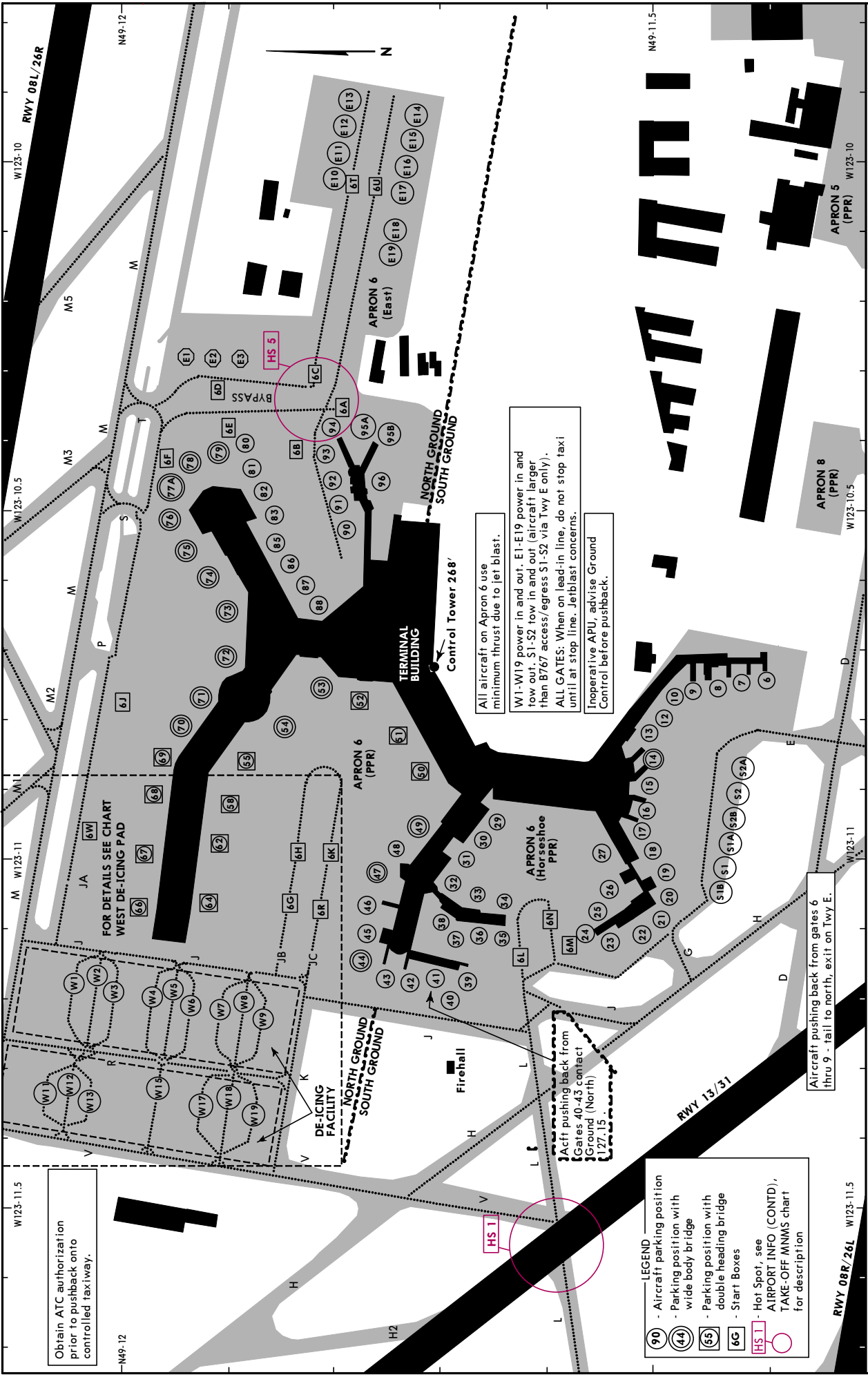

PARKING POSITION COORDINATES

POSITION No.	COORDINATES	POSITION No.	COORDINATES	POSITION No.	COORDINATES	POSITION No.	COORDINATES
6 thru 8	N49 11.4 W123 10.7	36 thru 38	N49 11.7 W123 11.1	93, 94, 95A	N49 11.8 W123 10.4	S1, S1A, S1B	N49 11.4 W123 11.0
9, 10, 12, 13	N49 11.5 W123 10.8	39 thru 43	N49 11.7 W123 11.2	96, 95B	N49 11.7 W123 10.4	S2, S2A, S2B	N49 11.4 W123 10.9
14 thru 16	N49 11.5 W123 10.9	44 thru 46	N49 11.8 W123 11.1	96	N49 11.7 W123 10.5	W1	N49 12.1 W123 11.2
17 thru 19	N49 11.5 W123 11.0	47	N49 11.7 W123 11.0	E1 thru E3	N49 11.9 W123 10.3	W2 thru W4	N49 12.0 W123 11.2
20 thru 22	N49 11.5 W123 11.1	48, 49	N49 11.7 W123 11.0	E10	N49 11.8 W123 10.0	W5, W6	N49 12.0 W123 11.3
23 thru 25	N49 11.6 W123 11.1	50	N49 11.7 W123 10.9	E11 thru E13	N49 11.8 W123 09.9	W7 thru W9	N49 11.9 W123 11.3
26, 27	N49 11.5 W123 11.0	51	N49 11.7 W123 10.8	E14	N49 11.7 W123 09.8	W11 thru W13	N49 12.0 W123 11.3
29	N49 11.7 W123 10.9	52 thru 54	N49 11.8 W123 10.8	E15	N49 11.7 W123 10.0	W15	N49 12.0 W123 11.4
30 thru 33	N49 11.7 W123 11.0	55, 58	N49 11.9 W123 10.9	E16 thru E18	N49 11.8 W123 10.5	W17 thru W19	N49 11.9 W123 11.4
34, 35	N49 11.6 W123 11.1	62, 64	N49 11.9 W123 11.0	E19	N49 11.7 W123 10.1		

CYVR/YVR

JEPPESEN
14 APR 23 **10-9C** Eff 20 Apr

VANCOUVER, BC
VANCOUVER INTL

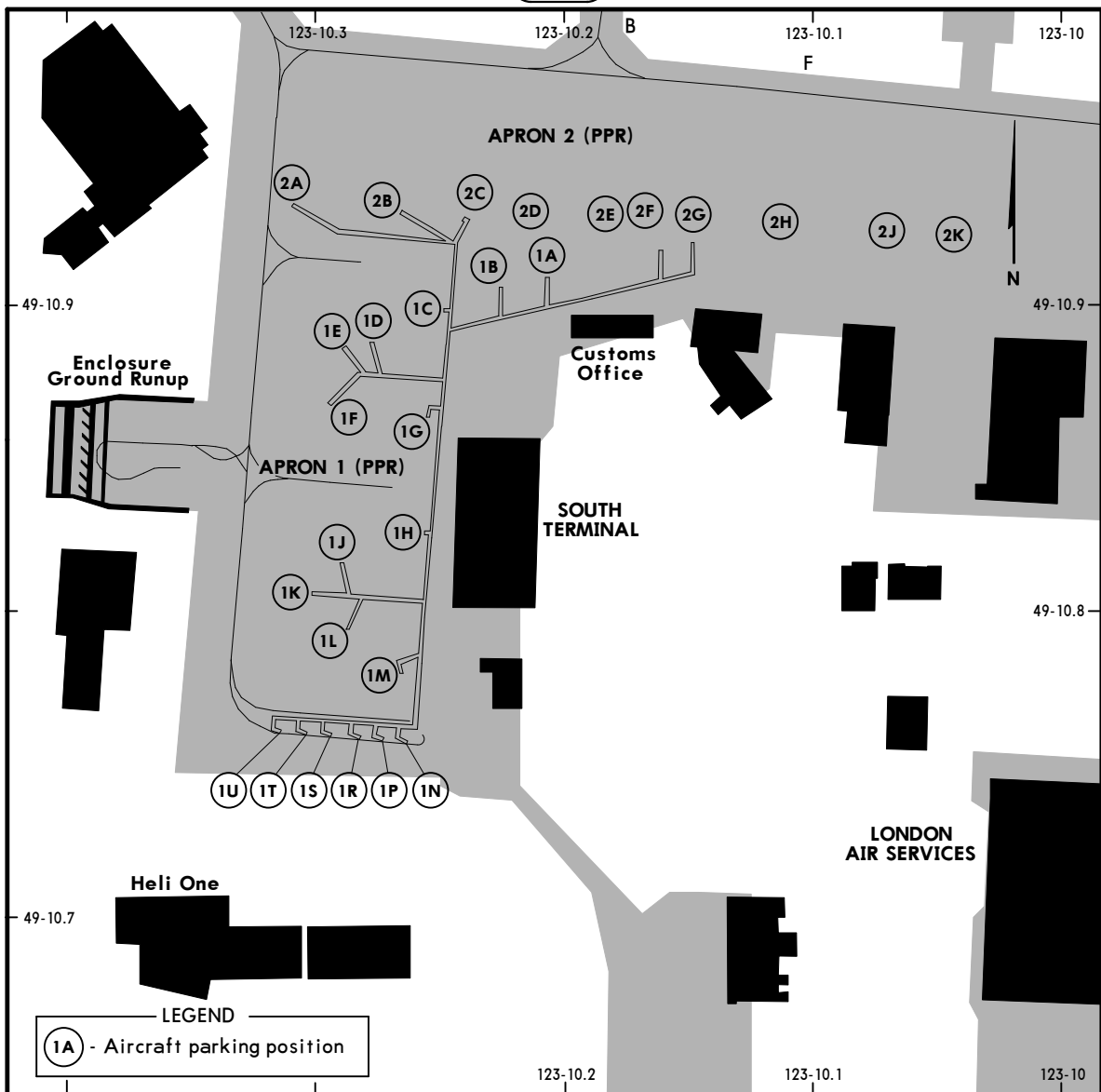

PARKING POSITION COORDINATES

POSITION No.	COORDINATES
1A, 1B, 1C	N49 10.9 W123 10.2
1D, 1E, 1F	N49 10.9 W123 10.3
1G	N49 10.9 W123 10.2
1H	N49 10.8 W123 10.2
1J, 1K, 1L, 1M, 1N	N49 10.8 W123 10.3
1P, 1R, 1S, 1T, 1U	N49 10.8 W123 10.3
2A	N49 10.9 W123 10.3
2B, 2C, 2D, 2E, 2F	N49 10.9 W123 10.2
2G, 2H, 2J	N49 10.9 W123 10.1
2K	N49 10.9 W123 10.0

CYVR/YVR

JEPPESEN
14 APR 23 10-9D Eff 20 Apr

VANCOUVER, BC
VANCOUVER INTL

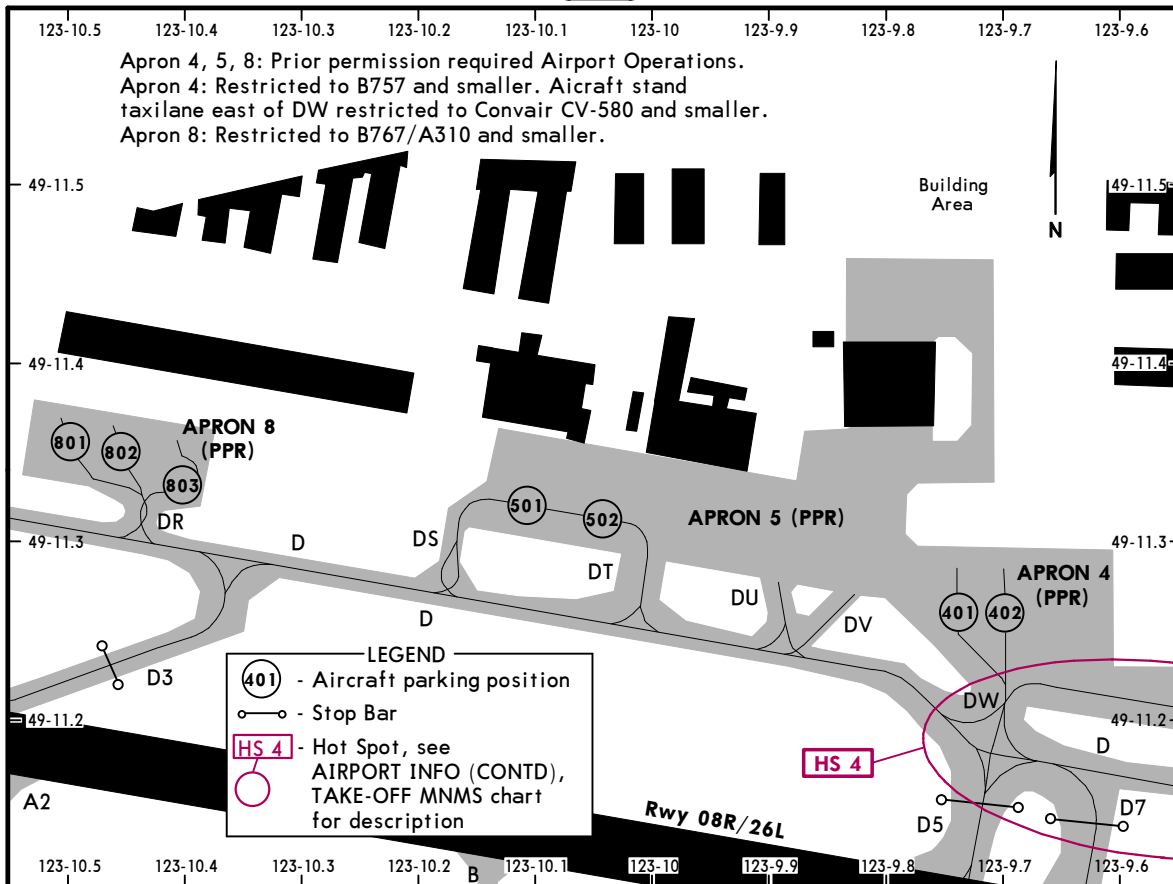

PARKING POSITION COORDINATES

POSITION No.	COORDINATES
401, 402	N49 11.3 W123 09.7
501	N49 11.3 W123 10.1
502	N49 11.3 W123 10.0
801, 802	N49 11.4 W123 10.5
803	N49 11.3 W123 10.4

CYVR/YVR



 14 APR 23 **10-9E** **Eff 20 Apr**
VANCOUVER, BC
VANCOUVER INTL**DE-ICING PROCEDURES****DE-ICING GENERAL:**

1. De-icing at gates permitted for frost removal only, contact VANCOUVER DE-ICE on 129.95.
2. De-icing pad West is positively controlled when De-icing OPS are in effect, PAD CONTROL is providing control of all aircraft and vehicle movements on this surface.
3. 30 minutes prior to pushback or taxi, advise VANCOUVER DE-ICE on 129.95 that de-icing is required, the type(s) of fluids required and the aircraft type. VANCOUVER DE-ICE will designate de-ice pad.
4. When requesting pushback or taxi clearance, advise ATC that de-icing is required and designated de-ice pad.
5. When advised by ATC, contact PAD CONTROL on 131.975 for instructions in the de-icing center and assignment to a de-icing bay.
6. Follow PAD CONTROL instructions to de-icing bay.
7. When advised by PAD CONTROL, contact ICEMAN on 130.7 and confirm brakes set, aircraft configured, engines at idle, de-icing fluid requirements and any special de-icing instructions.
8. After de-icing is completed and the aircraft has been inspected, ICEMAN will confirm aircraft is clean, start time for HOLDOVER and types of fluids applied.
9. When advised by ICEMAN, contact PAD CONTROL on 131.975 for instructions.

UNDER NO CIRCUMSTANCES MAY THE AIRCRAFT BE MOVED BEFORE PAD CONTROL ADVISES THAT THE AIRCRAFT IS CLEARED TO TAXI OUT OF THE BAY.

WEST PAD:

1. Aircraft queuing is on Twy V at Twy K and on Twy M.
2. Narrow-body aircraft will use positions W1, W3, W4, W6, W7, W9, W17 and W19, indicated by yellow inset guidance lights.
3. When transferred from ATC, follow PAD CONTROL instructions to de-icing bays.

GROUND RUN-UP ENCLOSURE (GRE):

Operators must receive an orientation for the GRE facility prior to use. Crews may contact the Icehouse to schedule de-icing up to 120 minutes prior to departure. Information required:

- Aircraft type, flight number/call sign, and the type(s) of fluids required.

Parking position 2A, on Apron 1, is the only staging position for the facility.

Aircraft waiting to use the GRE must remain on their aprons until 2A becomes available.

All propeller aircraft and jet aircraft with a wingspan of 71' (21.6m) or less (Dassault Falcon 900 with winglets and smaller) may power in/out of the facility.

ICEMAN will advise if engines should be running during de-icing.

ENTRY PROCEDURE:

1. Before contacting ATC for taxi, contact ICEMAN 130.925 for position in de-icing queue.
2. When ICEMAN approves access to either the staging position (2A) or GRE, contact ATC 121.7 for taxi.
3. Proceed as instructed by ICEMAN. CAUTION: DO NOT enter GRE until instructed by ICEMAN.
4. Advise ICEMAN 130.925 when stopped in the GRE.

DE-ICING PROCEDURE:

5. Contact ICEMAN 130.925 to confirm brakes set, aircraft configured, engines idle, and provide fluid requirements.
6. After de-icing is complete and the aircraft has been inspected, ICEMAN will confirm aircraft is clean, start time for HOLDOVER and types of fluids applied.

EXIT PROCEDURE:

7. When ready to taxi contact ICEMAN 130.925 for instructions.

CYVR/YVR

JEPPesen
23 DEC 22 **10-9F**

VANCOUVER, BC
VANCOUVER INTL

WEST DE-ICING PAD

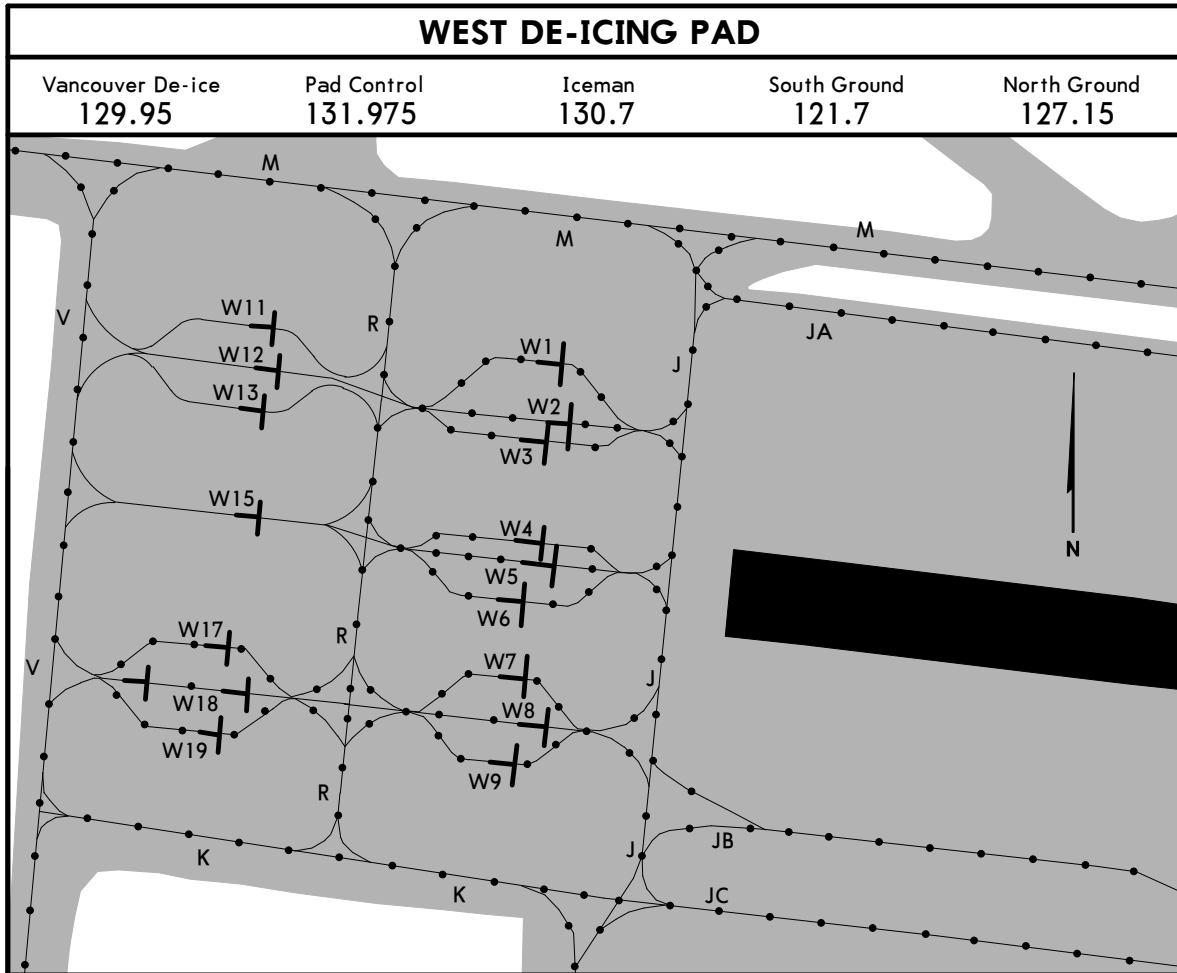

LEGEND

Hold line
 Inset Guidance Lights

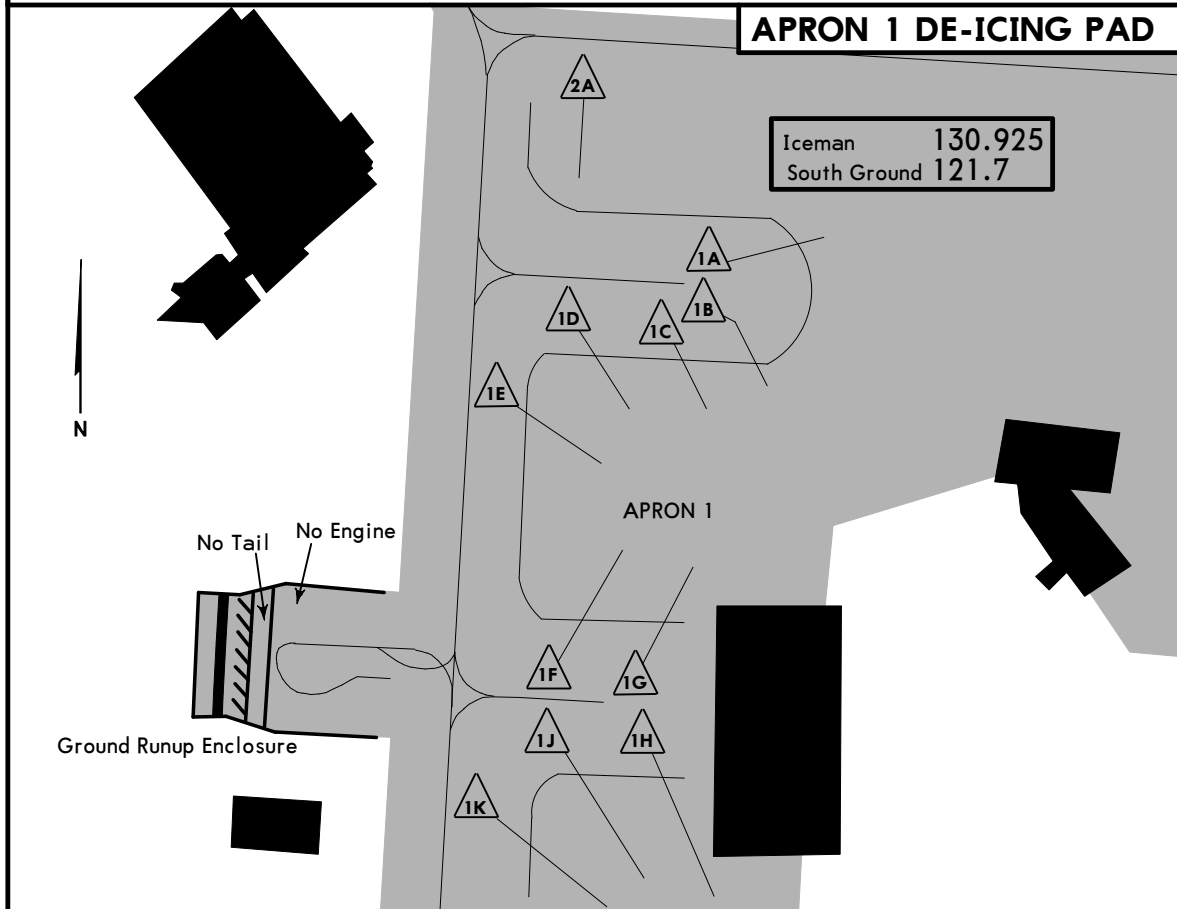

CYVR/YVR

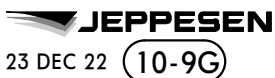

VANCOUVER, BC
VANCOUVER INTL

LOW VISIBILITY PROCEDURES
(RVR LESS THAN 1200 TO 600 FT)

APPLICATION

These procedures apply to ground movements of aircraft arriving and departing under low visibility conditions. Arrivals and departures below RVR 600 are not authorized. When weather conditions indicate visibility below RVR 1200 is imminent, procedures will be implemented restricting aircraft and vehicle operations on the movement area. The following message will be added to the ATIS broadcast: Low visibility procedures in effect for (name of applicable runway).

GENERAL

Taxi Routes

Low Visibility Taxi Routes are equipped with green inset centerline lighting. Some taxiway/taxiway intersections have been identified with three inset yellow centerline lights. Midfield crossings of 08R/26L are not permitted during low visibility operations.

Airport Surface Detection Equipment (ASDE)

Ground radar is used to monitor the position of aircraft operating on the maneuvering area. In the event of an ASDE failure, ATC may suspend, restrict or terminate low visibility operations.

DEPARTURES

The primary runways for departure are 08R/26L. Yellow flashing runway guard lights (wig-wags) and stop bars are installed abeam each hold line. Intersection take-offs are not permitted.

Sequencing of Aircraft Ground Movement for Take-off

Do not request start, push back or call for taxi clearance until the reported RVR is greater than:

<u>Aircraft/Pilot Take-off Minima</u>	<u>Minimum RVR for Start</u>
1200 RVR	1000 RVR
600 RVR	600 RVR

SMGCS Rwy 08L/26R and 08R/26L

Runway/taxiway intersections are equipped with yellow flashing runway guard lights and stop bars consisting of red inset lights and red elevated lights located at the taxi hold position. At runway entry points, M10, M8, M7, M9, N7, L, D, D5, D7, DY, C and A, when the red stop bar lights are illuminated, green lead-on lights beyond the stop bar are extinguished. When ATC issues a clearance to proceed onto the runway, the red stop bar lights will be extinguished and the green lead-on lights beyond the stop bar will be illuminated. The stop bar is reset automatically as the aircraft moves onto the runway.

"AT NO TIME SHALL A PILOT CROSS AN ILLUMINATED RED STOP BAR"

ARRIVALS

The primary runways for arrival are 08L/26R.

Plan to exit on the centerline lighted rapid exit taxiways and proceed beyond the alternating green and yellow centerline lights to the taxi intersection lights to ensure the aircraft is clear of the runway and the ILS sensitive area.

CYVR/YVR
VANCOUVER INTL

JEPPESEN
17 FEB 23
Eff 23 Feb

SMGCS
VANCOUVER, BC

LOW VISIBILITY TAXI CHART
LAND Rwy 08L/08R, DEPART Rwy 08L/08R

LESS THAN RVR 1200 to 600

For Low Visibility Procedures See 10-9D

D-ATIS 124.6		Data Comm D-ATIS PDC	VANCOUVER Clearance 121.4		North 127.15	South 121.7
North 119.55	South 118.7	Tower 124.0	125.65	PACIFIC Radio 123.15	VANCOUVER Departure North 126.125 South 132.3	

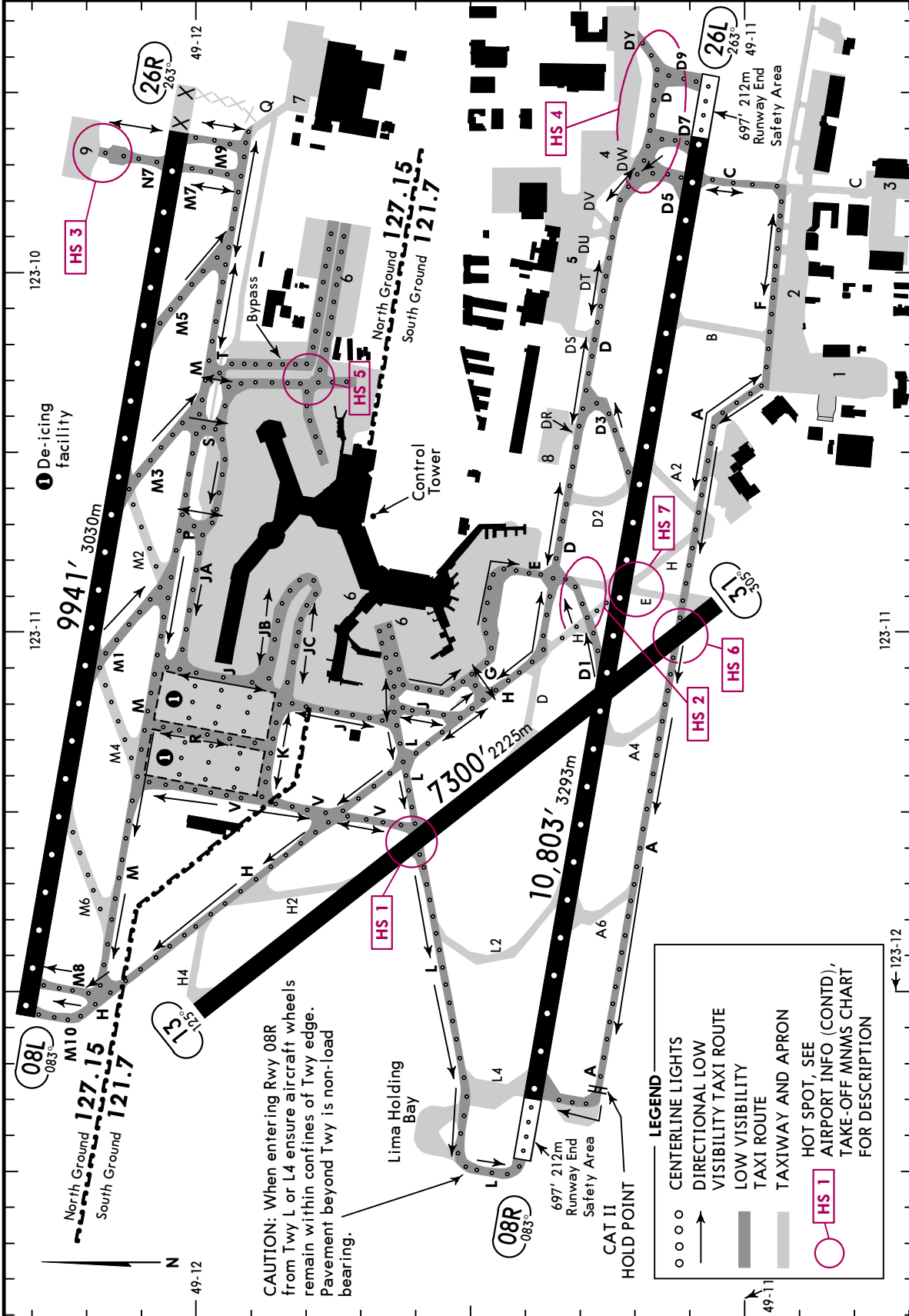

CAUTION: When entering Rwy 08R from Twy L or L4 ensure aircraft wheels remain within confines of Twy edge. Pavement beyond Twy is non-load bearing.

LEGEND

- o o o CENTERLINE LIGHTS
- DIRECTIONAL LOW VISIBILITY TAXI ROUTE
- ▬ LOW VISIBILITY TAXI ROUTE
- ▬ TAXIWAY AND APRON
- HOT SPOT, SEE AIRPORT INFO (CONTD), TAKE-OFF MNMS CHART FOR DESCRIPTION
- HS 1

CYVR/YVR VANCOUVER INTL

JEPPESEN
17 FEB 23
Eff 23 Feb (10-9J)

SMGCS
VANCOUVER, BC

LESS THAN RVR 1200 to 600

LOW VISIBILITY TAXI CHART
LAND Rwy 26L/26R, DEPART Rwy 26L/26R

For Low Visibility Procedures See 10-9D

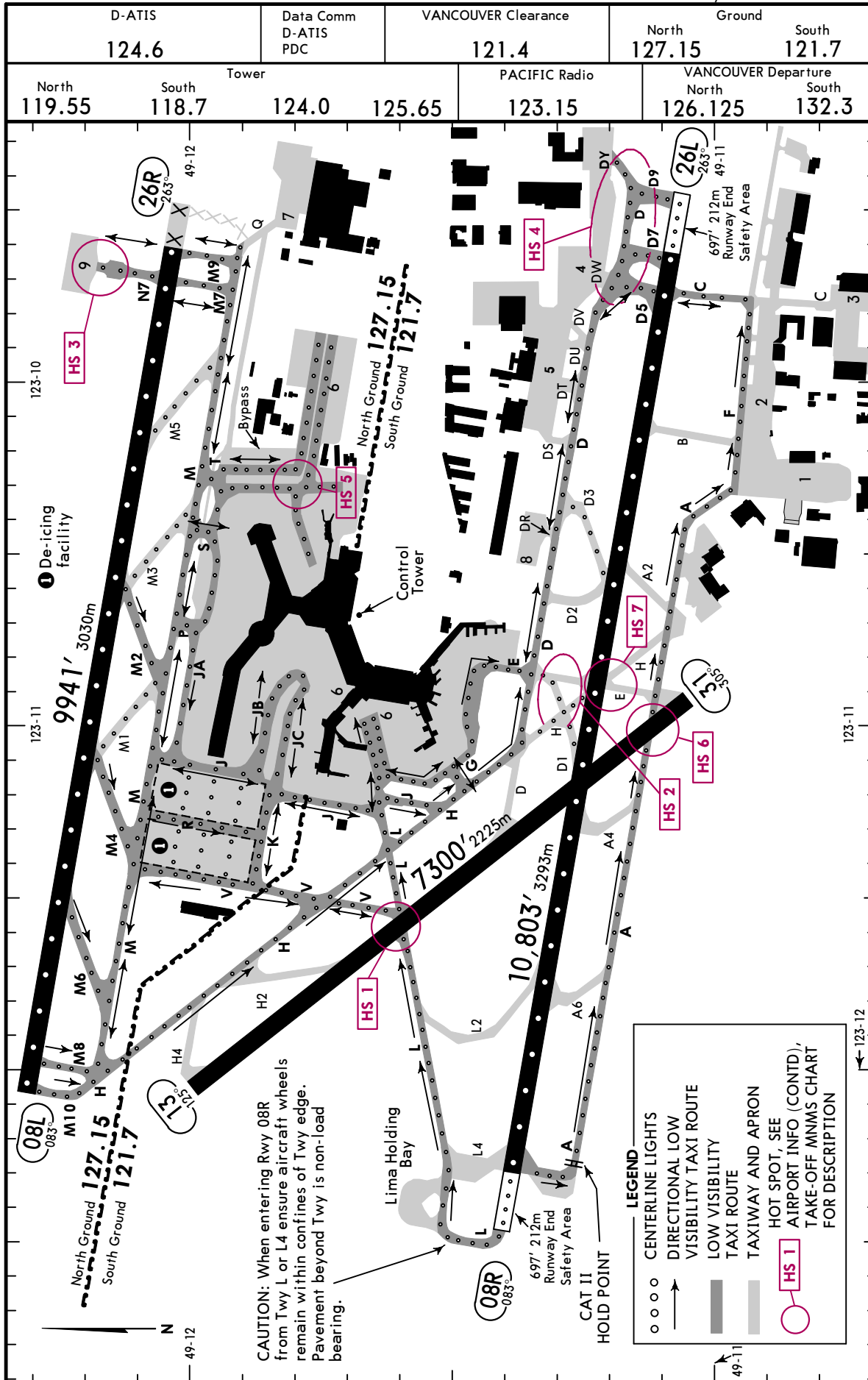

CHANGES: Hot Spots 6 & 7 added.

CYVR/YVR

VANCOUVER INTL

JEPPesen
17 FEB 23 **(11-1) Eff 23 Feb**

VANCOUVER, BC
ILS Z Rwy 08L

D-ATIS 124.6		PACIFIC Radio 123.15		VANCOUVER Arrival				
				Outer 128.17 128.6		Inner 133.1 134.225		
VANCOUVER Tower				Ground				
North 119.55		South 118.7		North 127.15		South 121.7		
LOC ITL 110.55	Final Apch Crs 083°	GS OMRAD 2030' (2017')	ILS DA(H) Refer to Minimums	Apt Elev 13' TDZE 13'		<p>MSA YVR VOR</p>		
MISSED APCH: Do not exceed 230 KT until SESPI. Climbing LEFT turn to 3000' direct to SESPI. As required shuttle climb.								
Alt Set: INCHES		Trans level: FL180		Trans alt: 18000'				
1. Radar or RNAV required. 2. SAFE ALTITUDE WITHIN 100 NM 12,800'. 3. Procedure turn NOT AUTHORIZED. 4. Simultaneous approach AUTHORIZED with Rwy 08R. 5. Localizer reliable only within 10° either side of centerline. 6. Non RNAV aircraft must obtain missed approach instructions from ATC.								

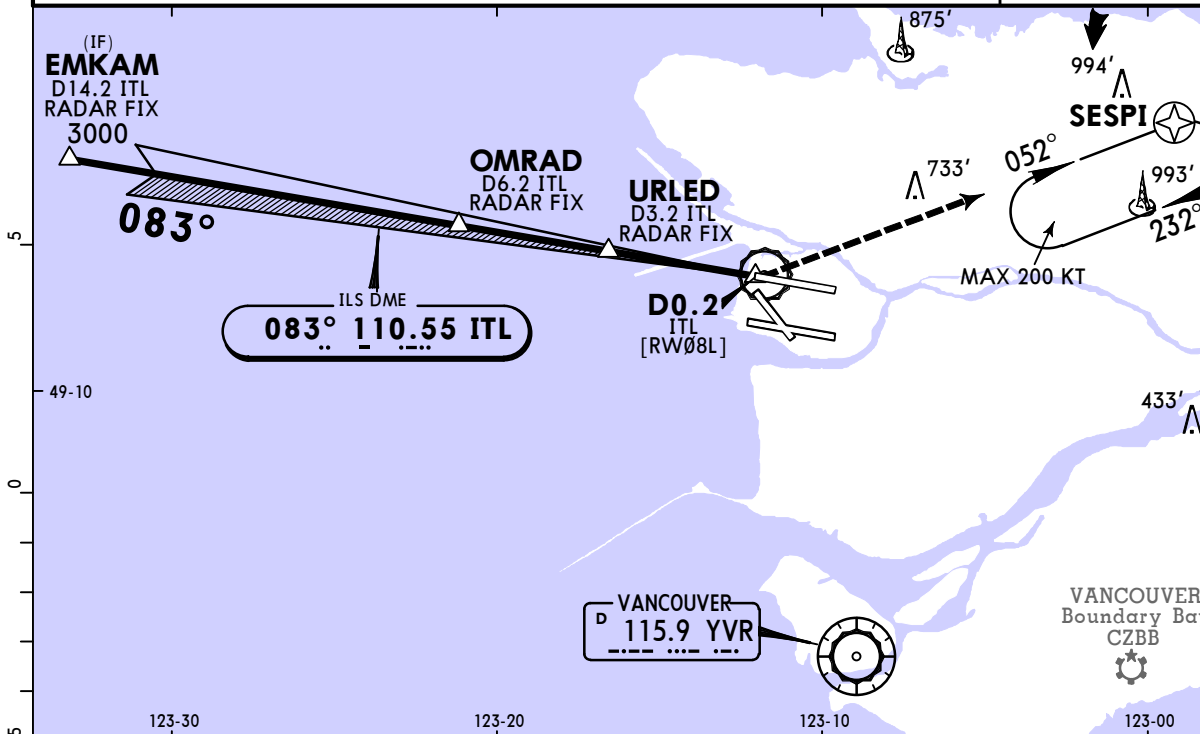

NM to ITL DME	14.2	12.0	11.0	10.0	9.4	8.0	7.0	6.0	5.0	4.0	3.0	2.0	0.9
VDA ALTITUDE	4530'	3830'	3510'	3190'	3000'	2560'	2240'	1920'	1600'	1280'	970'	650'	300'

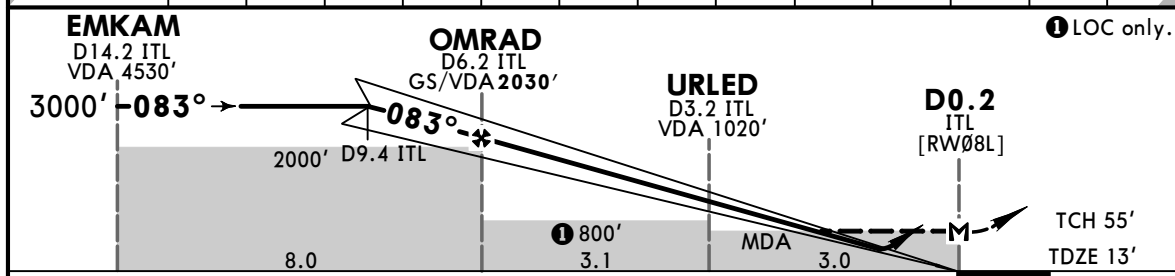

Gnd speed-Kts	70	90	100	120	140	160	ALSF-II PAPI 230 KT MAX UNTIL SESPI 3000' LT
GS/VDA	3.00°	372	478	531	637	743	
MAP at D0.2 ITL							
OMRAD to MAP	6.1	5:14	4:04	3:40	3:03	2:17	

STRAIGHT-IN LANDING RWY08L			
ILS DME or ILS RADAR		LOC (GS out) DME or LOC (GS out) RADAR	
DA(H) 213' (200')		DA(H) 263' (250')	
FULL		HIALS out	
MDA(H) 300' (287')		MDA(H) 300' (287')	
FULL		HIALS out	
A			
B			
C	RVR 26 or 1/2	RVR 50 or 1	RVR 50 or 1
D			

CYVR/YVR VANCOUVER INTL

JEPPESSEN
17 FEB 23
Eff 23 Feb

VANCOUVER, BC 11-1A ILS CAT II or III Y Rwy 08L

D-ATIS 124.6		PACIFIC Radio 123.15		VANCOUVER Arrival Outer 128.17 128.6		Inner 133.1 134.225			
VANCOUVER Tower North 119.55				South 118.7		Ground North 127.15		South 121.7	
LOC ITL 110.55	Final Apch Crs 083°	GS OMRAD 2030' (2017')	CAT IIIC NA	CAT IIIB NA	CAT IIIA Refer to Minimums	CAT II ILS RA 113' DA(H) 113'(100')	Apt Elev 13' TDZE 13'	<p>MSA YVR VOR</p>	
MISSED APCH: Climb to 420' heading 083°. Then climbing LEFT turn to 3500' heading 068°. Intercept inbound R-252 YPK to YPK VOR.									
Alt Set: INCHES				Trans level: FL180		Trans alt: 18000'			
1. Radar or RNAV required. 2. PRIOR AUTHORIZATION REQUIRED FROM TRANSPORT CANADA. 3. SAFE ALTITUDE WITHIN 100 NM 12,800'. 4. Procedure turn NOT AUTHORIZED. 5. Simultaneous approach AUTHORIZED with Rwy 08R. 6. Localizer reliable only within 10° either side of centerline.									

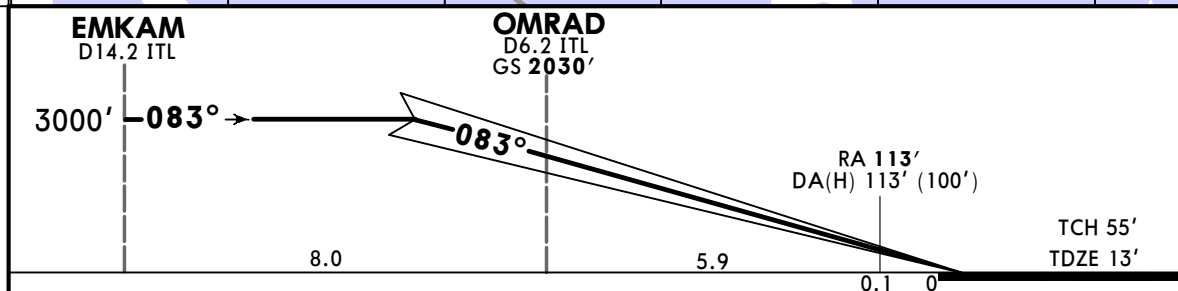
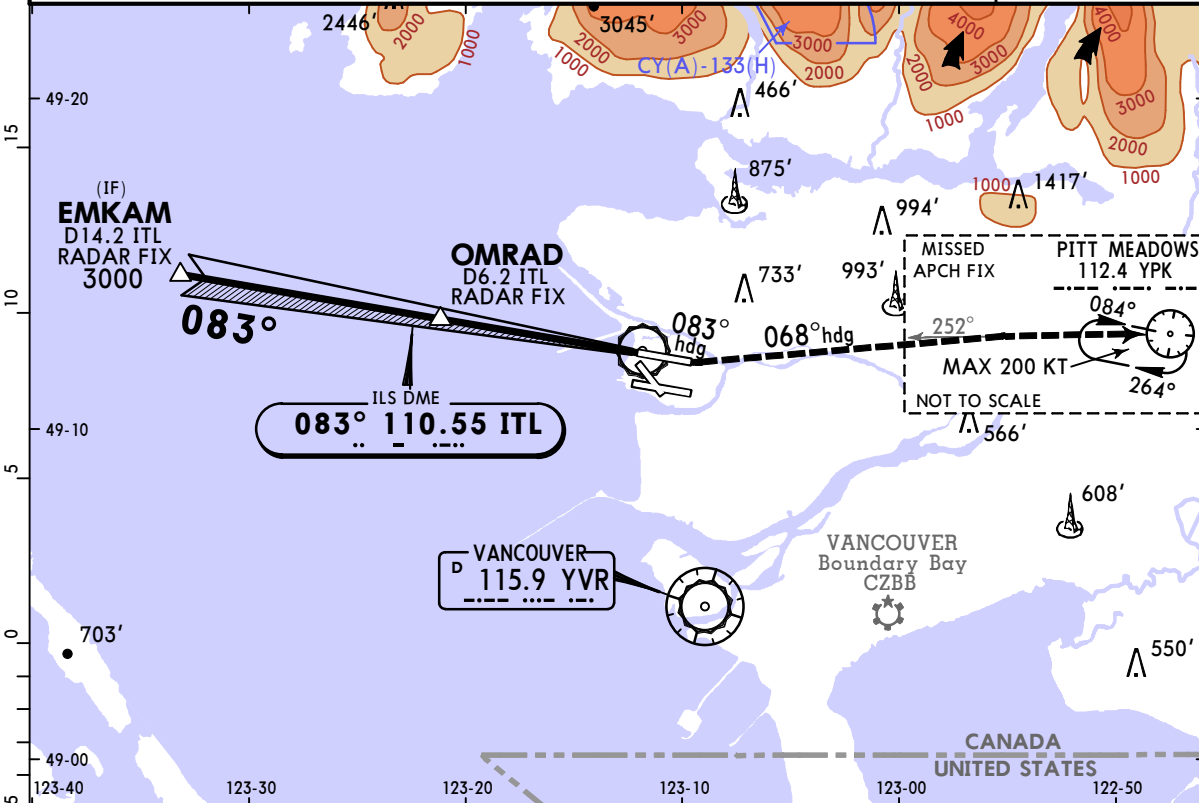

Gnd speed-Kts	70	90	100	120	140	160	ALSF-II	420'	083° hdg	3500'	068° hdg
GS	3.00°	372	478	531	637	849					
							PAPI			LT	

STRAIGHT-IN LANDING RWY08L			
CAT IIIC ILS	CAT IIIB ILS	CAT IIIA ILS	CAT II ILS RA 113' DA(H) 113'(100')
NOT AUTHORIZED	NOT AUTHORIZED	RVR 6	RVR 12

CYVR/YVR
VANCOUVER INTL

JEPPESEN
17 FEB 23 (11-2) Eff 23 Feb

VANCOUVER, BC
ILS Rwy 08R

BRIEFING STRIP™	D-ATIS	PACIFIC Radio		VANCOUVER Arrival				
	124.6	123.15		Outer	128.17	128.6	Inner	
	VANCOUVER Tower		Ground					
	North	119.55	124.0	South	118.7	North	127.15	South
LOC	Final	GS	ILS DME	Apt Elev 13'				
IVR	Apch Crs	TAVPI	DA(H)	TDZE 9'				
109.5	083°	2030' (2021')	Refer to Minimums					
MISSED APCH: Climb to 420' heading 083°. Then climbing RIGHT turn to 2000' heading 113°. Then RIGHT turn direct to YVR VOR. Shuttle climb at YVR VOR to 5400' before proceeding on course.								
Alt Set: INCHES		Trans level: FL180		Trans alt: 18000'				
1. SAFE ALTITUDE WITHIN 100 NM 12,800'. 2. Simultaneous approach AUTHORIZED with Rwy 08L. 3. LOC reliable only within 10° either side of centerline.								

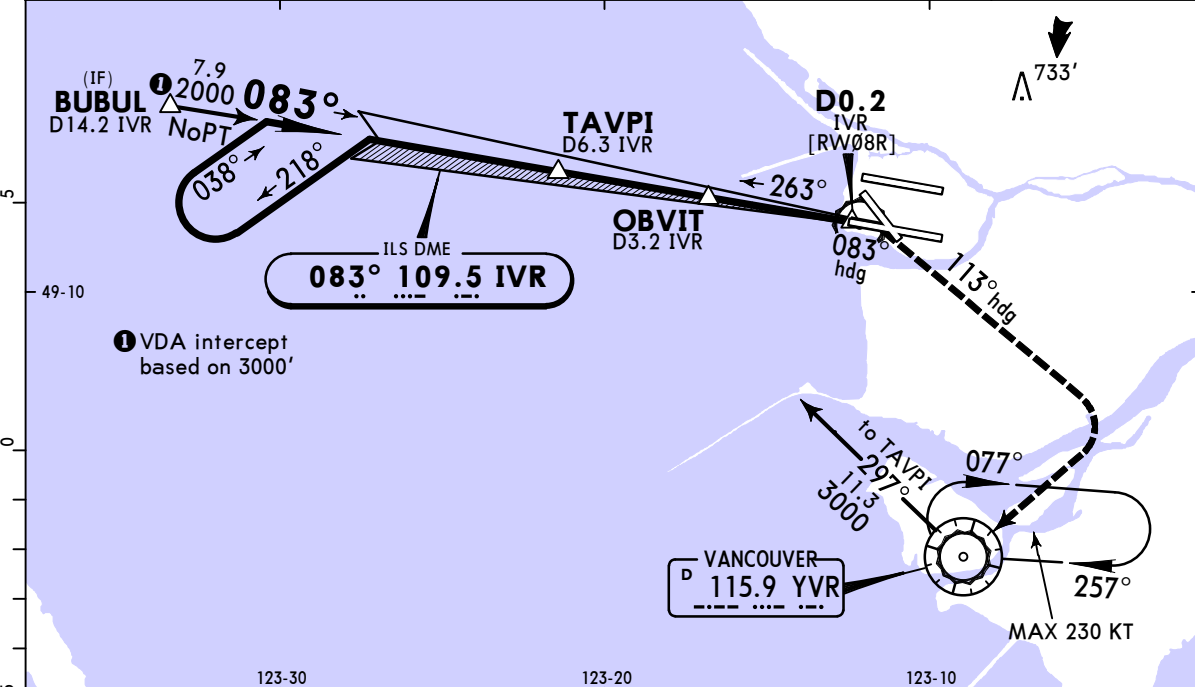

	14.2	12.0	11.0	10.0	9.4	8.0	7.0	6.0	5.0	4.0	3.0	2.0	0.9
NM to IVR DME	4530'	3830'	3510'	3190'	3000'	2550'	2230'	1920'	1600'	1280'	960'	640'	280'
VDA ALTITUDE													

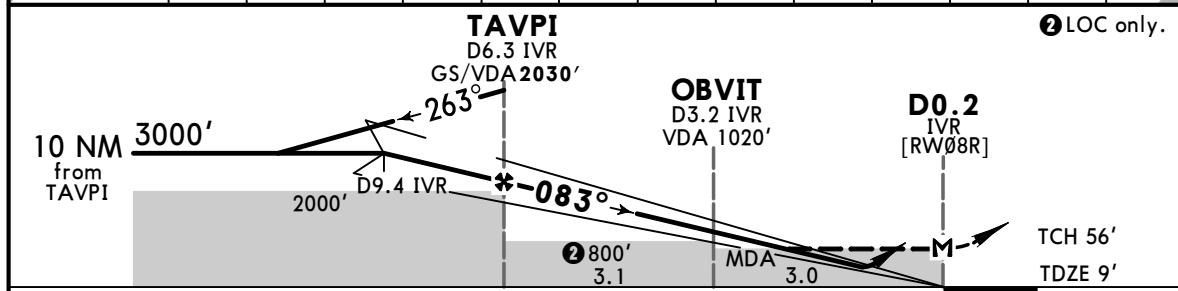

Gnd speed-Kts	70	90	100	120	140	160	ALSF-II PAPI	420'	083° hdg	2000'	113° hdg
GS/VDA	3.00°	372	478	531	637	743		849	↑	↑	RT
MAP at D0.2 IVR											

STRAIGHT-IN LANDING RWY08R			
ILS DME DA(H) 209' (200') FULL		LOC (GS out) DME DA(H) 259' (250') HIALS out	
MDA(H) 280' (271') HIALS out			
A			
B			
C	RVR 26 or 1/2	RVR 50 or 1	RVR 50 or 1
D			

CYVR/YVR
VANCOUVER INTL

JEPPesen
17 FEB 23
Eff 23 Feb (11-2A)

VANCOUVER, BC
ILS CAT II or III Rwy 08R

D-ATIS 124.6		PACIFIC Radio 123.15		VANCOUVER Arrival Outer 128.17 128.6		Inner 133.1 134.225			
VANCOUVER Tower North 119.55				South 118.7		Ground North 127.15		South 121.7	
LOC IVR 109.5	Final Apch Crs 083°	GS TAVPI 2030' (2021')	CAT IIIC NA	CAT IIIB NA	CAT IIIA Refer to Minimums	CAT II ILS RA 99' DA(H) 109' (100')	Apt Elev 13' TDZE 9'	<p>MSA YVR VOR</p>	
<p>MISSED APCH: Climb to 420' heading 083°. Then climbing RIGHT turn to 2000' heading 113°. Then RIGHT turn direct to YVR VOR. Shuttle climb at YVR VOR to 5400' before proceeding on course.</p>									
Alt Set: INCHES		Trans level: FL180		Trans alt: 18000'					
<p>1. PRIOR AUTHORIZATION REQUIRED FROM TRANSPORT CANADA. 2. SAFE ALTITUDE WITHIN 100 NM 12,800'. 3. Simultaneous approach AUTHORIZED with Rwy 08L. 4. LOC reliable only within 10° either side of centerline.</p>									

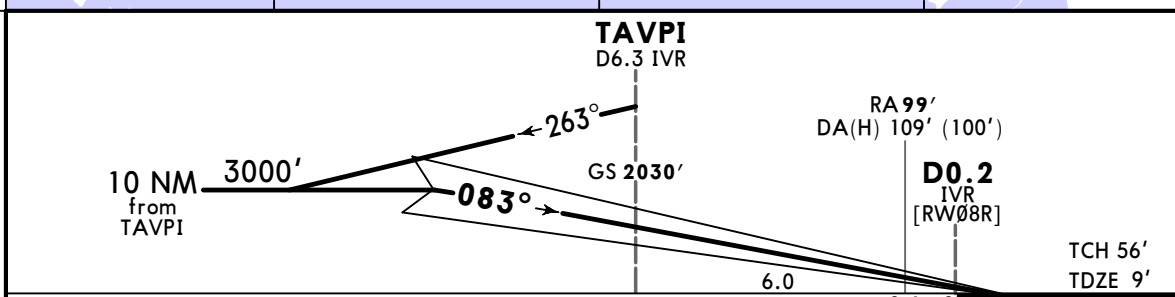
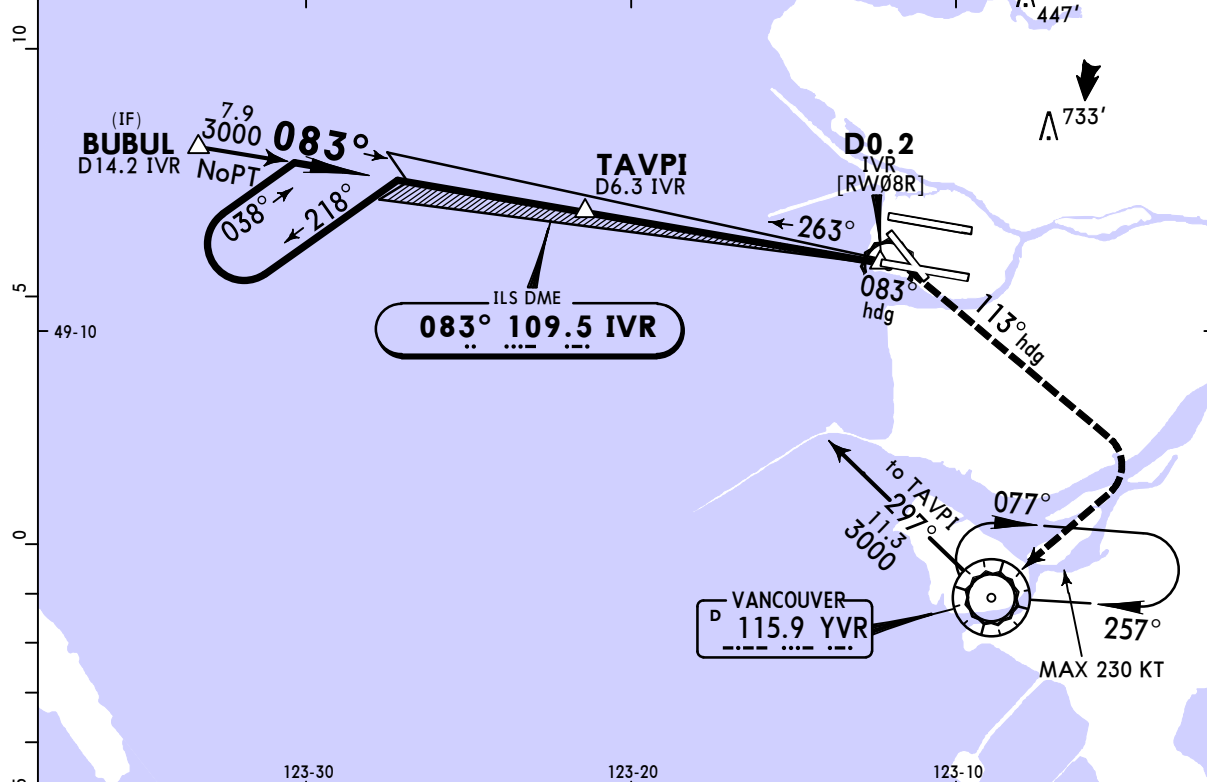

Gnd speed-Kts	70	90	100	120	140	160	ALSF-II PAPI 	420'	083° hdg	2000'	113° hdg
GS	3.00°	372	478	531	637	743		849	↑	↑ RT	

STRAIGHT-IN LANDING RWY08R			
CAT IIIC ILS	CAT IIIB ILS	CAT IIIA ILS	CAT II ILS RA 99' DA(H) 109' (100')
NOT AUTHORIZED	NOT AUTHORIZED	RVR 6	RVR 12

CYVR/YVR
VANCOUVER INTL

JEPPESSEN
16 SEP 22 (11-3)

VANCOUVER, BC
ILS Rwy 13

BRIEFING STRIP™	D-ATIS	PACIFIC Radio		VANCOUVER Arrival		
	124.6	123.15		Outer	Inner	
	VANCOUVER Tower		Ground			
	North	South	North	South		
	119.55	118.7	127.15	121.7		
LOC IMK	Final Apch Crs	GS DATSI	ILS DME DA(H)	Apt Elev 13'	TDZE 8'	
111.1	125°	2690' (2682')	258' (250')			
MISSED APCH: Climb to 3000' heading 125°. Then LEFT turn direct to WC NDB. Shuttle to 7500' before proceeding on course.						
Alt Set: INCHES			Trans level: FL180		Trans alt: 18000'	
1. SAFE ALTITUDE WITHIN 100 NM 12,800'. 2. LOC reliable only within 10° either side of centerline.					MSA YVR VOR	

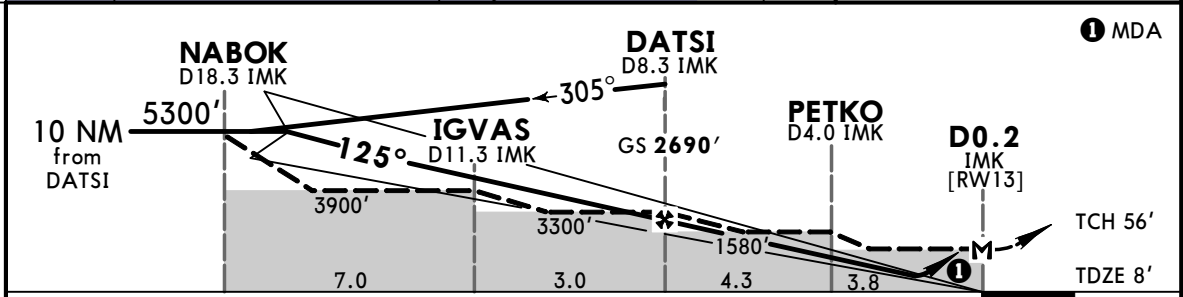
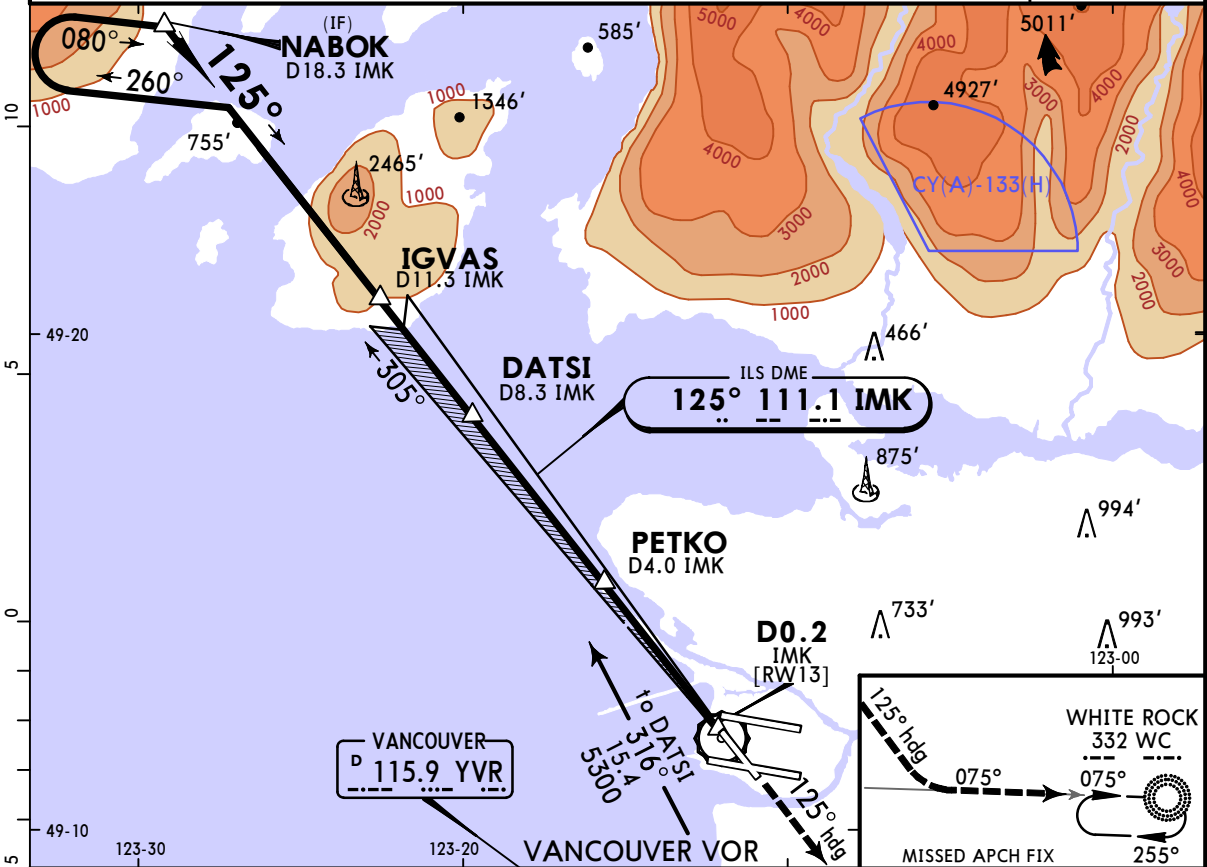
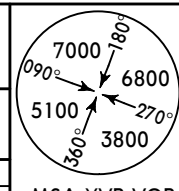

Gnd speed-Kts	70	90	100	120	140	160	ODALS PAPI 3000' 125° hdg LT WC 332
Gs	3.00°	372	478	531	637	743	
LOC Descent Angle	3.75°	465	597	664	796	1062	
MAP at D0.2 IMK							

STRAIGHT-IN LANDING RWY 13			
ILS DME		LOC (GS out) DME	
DA(H) 258' (250')		MDA(H) 440' (432')	
ALS out		ALS out	
A			
B			
C	1		1¼
D			

CHANGES: LOC descent angle.

CYVR/YVR VANCOUVER INTL

JEPPESSEN
17 FEB 23 **11-4** Eff 23 Feb

VANCOUVER, BC ILS Rwy 26L

BRIEFING STRIP™	D-ATIS	PACIFIC Radio		VANCOUVER Arrival		
	124.6	123.15		Outer	Inner	
	VANCOUVER Tower		Ground			
	North	South	North	South		
119.55	124.0	118.7	127.15	133.1 134.225		
LOC IFZ	Final Apch Crs	GS DUTOM	ILS DA(H) Refer to Minimums	Apt Elev 13'	TDZE 7'	
110.7	263°	2030' (2023')				
<p>MISSED APCH: Climb to 420' heading 263°. Then climbing LEFT turn to 2000' heading 233°. Intercept outbound R-283 YVR VOR. Then climb to 3000' to JORJA. Shuttle climb at JORJA to 4800' before proceeding on course.</p>						
<p>Alt Set: INCHES Trans level: FL180 Trans alt: 18000'</p> <p>1. Radar or RNAV required. 2. SAFE ALTITUDE WITHIN 100 NM 12,800'. 3. Procedure turn NOT AUTHORIZED. 4. Simultaneous approach AUTHORIZED with Rwy 26R. 5. LOC reliable only within 10° either side of centerline.</p>						

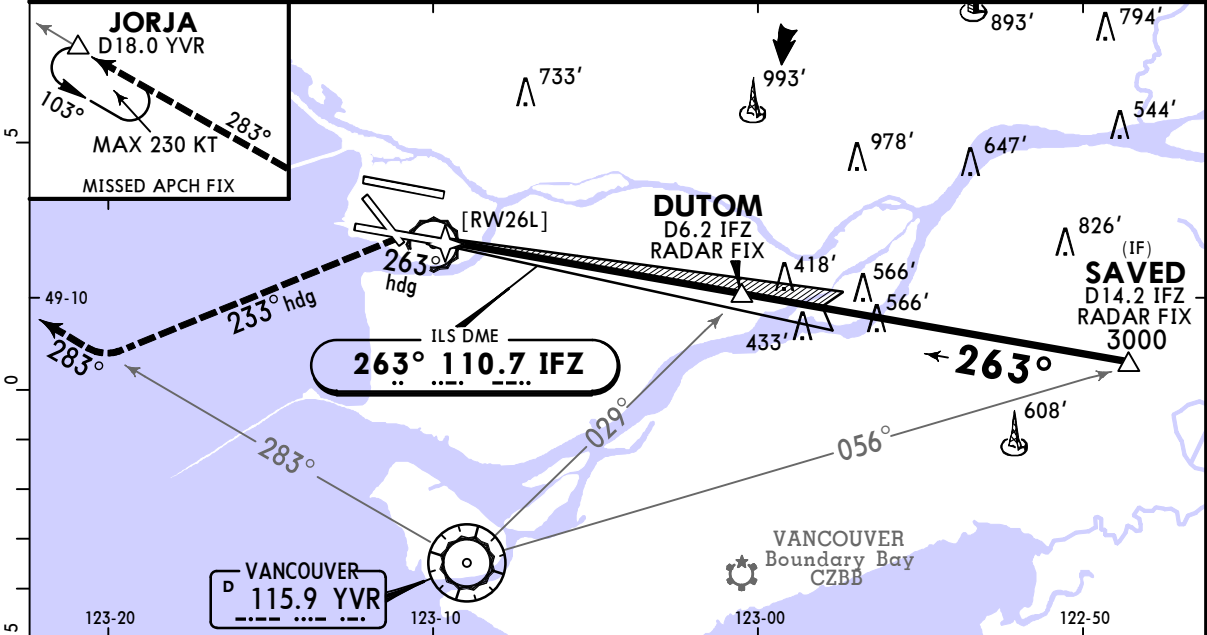
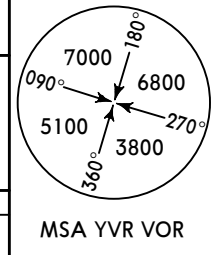

NM to IFZ DME	1.7	3.0	4.0	5.0	6.0	7.0	8.0	9.4	10.0	11.0	12.0	13.0	14.2
VDA ALTITUDE	540'	960'	1280'	1600'	1920'	2230'	2550'	3000'	3190'	3510'	3830'	4140'	4530'

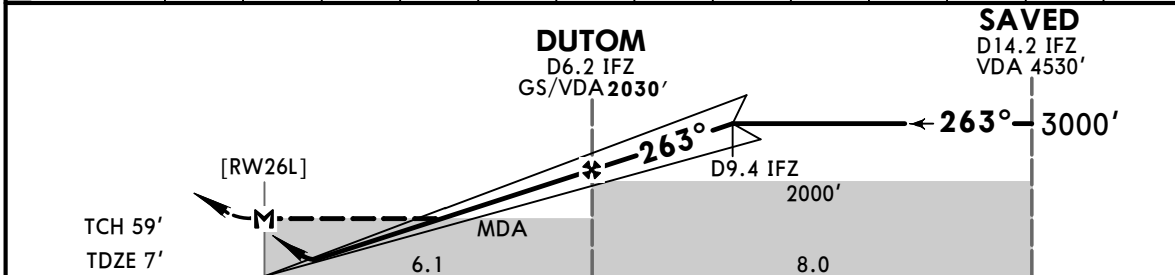

Gnd speed-Kts	70	90	100	120	140	160	ALSF-II	420'	263° hdg	2000'	233° hdg
GS/VDA	3.00°	372	478	531	637	849					
DUTOM to MAP	6.1	5:14	4:04	3:40	3:03	2:37	PAPI	↑	LT		

STRAIGHT-IN LANDING RWY26L			
ILS DME or ILS RADAR		LOC (GS out) DME or LOC (GS out) VOR	
DA(H) 207' (200')	DA(H) 257' (250')	MDA(H) 540' (533')	
FULL	HIALS out	HIALS out	
A			
B			
C	RVR 26 or 1/2	RVR 50 or 1	1 1/4
D			1 3/4

CYVR/YVR VANCOUVER INTL

JEPPESSEN
17 FEB 23
Eff 23 Feb **11-4A**

VANCOUVER, BC ILS CAT II or III Rwy 26L

D-ATIS 124.6		PACIFIC Radio 123.15		VANCOUVER Arrival			
				Outer 128.17	128.6	Inner 133.1	134.225
VANCOUVER Tower				Ground			
North 119.55		124.0		North 127.15		South 121.7	
LOC IFZ 110.7	Final Apch Crs 263°	GS DUTOM 2030' (2023')	CAT IIIC NA	CAT IIIB NA	CAT IIIA Refer to Minimums	CAT II ILS RA 103' DA(H) 107'(100')	Apt Elev 13' TDZE 7'
<p>MISSED APCH: Climb to 420' heading 263°. Then climbing LEFT turn to 2000' heading 233°. Intercept outbound R-283 YVR VOR. Then climb to 3000' to JORJA. Shuttle climb at JORJA to 4800' before proceeding on course.</p>							<p>MSA YVR VOR</p>
<p>Alt Set: INCHES Trans level: FL180 Trans alt: 18000'</p>							
<p>1. Radar or RNAV required. 2. PRIOR AUTHORIZATION REQUIRED FROM TRANSPORT CANADA 3. SAFE ALTITUDE WITHIN 100 NM 12,800'. 4. Procedure turn NOT AUTHORIZED. 5. Simultaneous approach AUTHORIZED with Rwy 26R. 6. LOC reliable only within 10° either side of centerline.</p>							

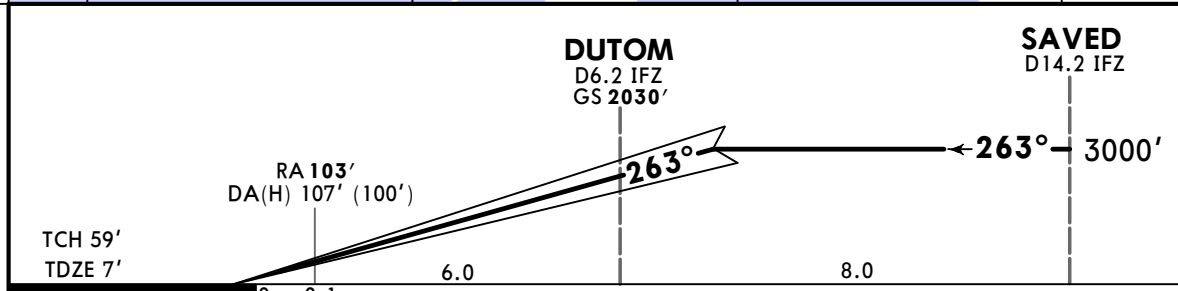
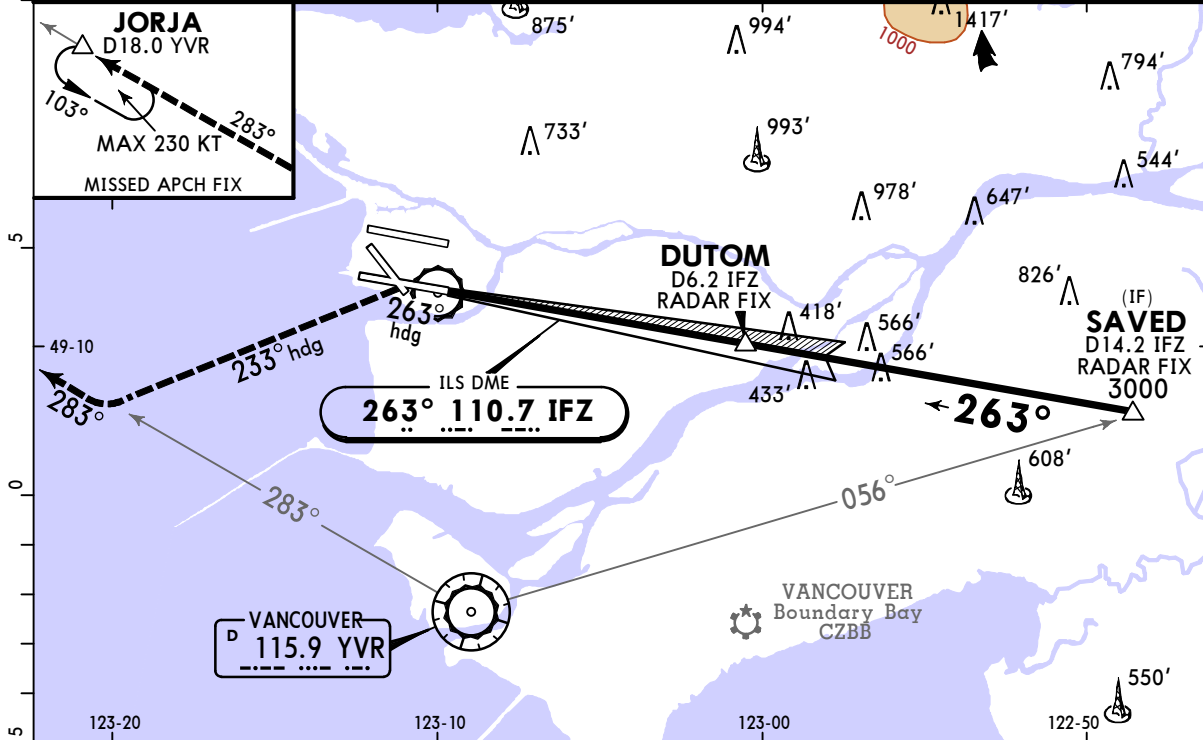

Gnd speed-Kts	70	90	100	120	140	160	ALSF-II PAPI	420'	263° hdg	2000'	233° hdg
GS	3.00°	372	478	531	637	849					

STRAIGHT-IN LANDING RWY26L			
CAT IIIC ILS	CAT IIIB ILS	CAT IIIA ILS	CAT II ILS RA 103' DA(H) 107'(100')
NOT AUTHORIZED	NOT AUTHORIZED	RVR 6	RVR 12

CYVR/YVR VANCOUVER INTL

JEPPESSEN
17 FEB 23 **(11-5) Eff 23 Feb**

VANCOUVER, BC ILS Rwy 26R

BRIEFING STRIP™	D-ATIS	PACIFIC Radio		VANCOUVER Arrival			
	124.6	123.15		Outer		Inner	
				128.175	128.6	133.1	134.225
VANCOUVER Tower				Ground			
North		South		North		South	
119.55		125.65		127.15		121.7	
LOC IRD	Final Apch Crs	GS TOTIM	ILS DA(H)	Apt Elev 13'			
111.95	263°	2030' (2021')	Refer to Minimums	TDZE 9'			
MISSED APCH: Climb to 420' heading 263°. Then climbing RIGHT turn to 3000' heading 294°. Intercept outbound YPK VOR R-261 to DUTNO. Shuttle climb at DUTNO to 5300' before proceeding on course.							
Alt Set: INCHES				Trans level: FL180		Trans alt: 18000'	
1. Radar or RNAV required. 2. SAFE ALTITUDE WITHIN 100 NM 12,800'. 3. Procedure turn NOT AUTHORIZED. 4. Simultaneous approach AUTHORIZED with Rwy 26L. 5. LOC reliable only within 10° either side of centerline.							

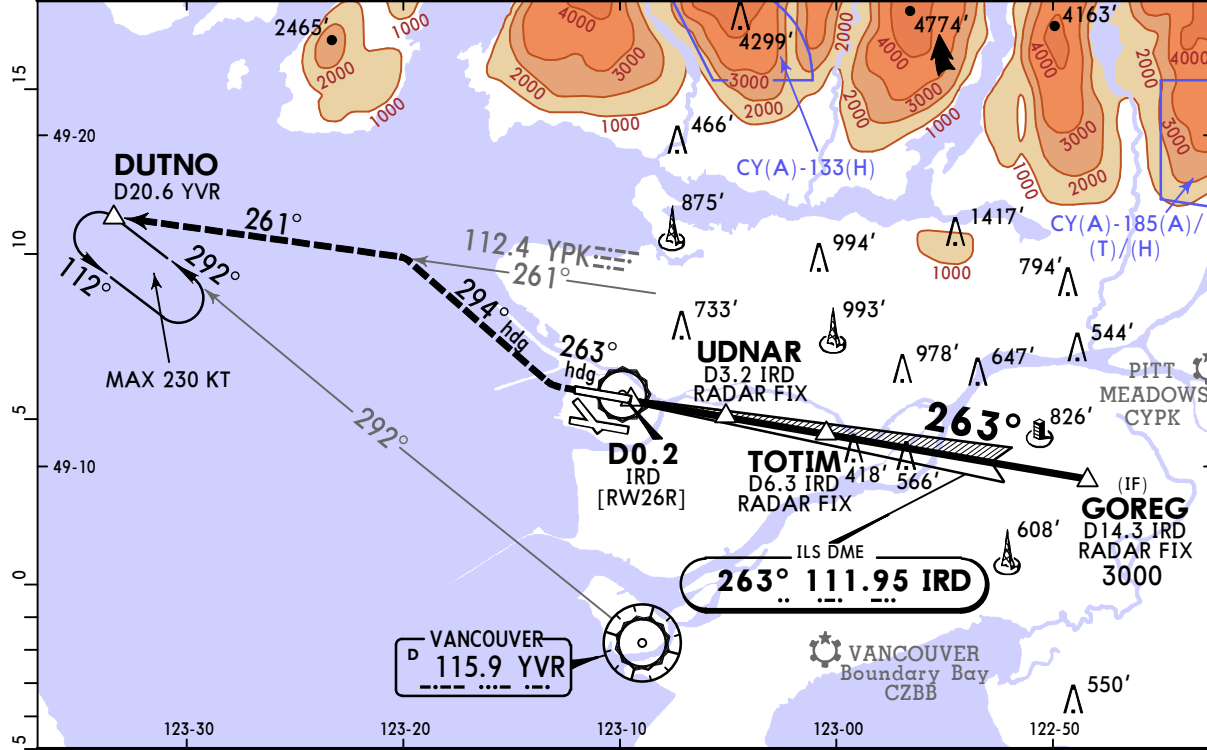

NM to IRD DME	1.9	3.0	4.0	5.0	6.0	7.0	8.0	9.4	10.0	11.0	12.0	13.0	14.3
VDA ALTITUDE	600'	960'	1280'	1600'	1920'	2230'	2550'	3000'	3190'	3510'	3830'	4140'	4560'

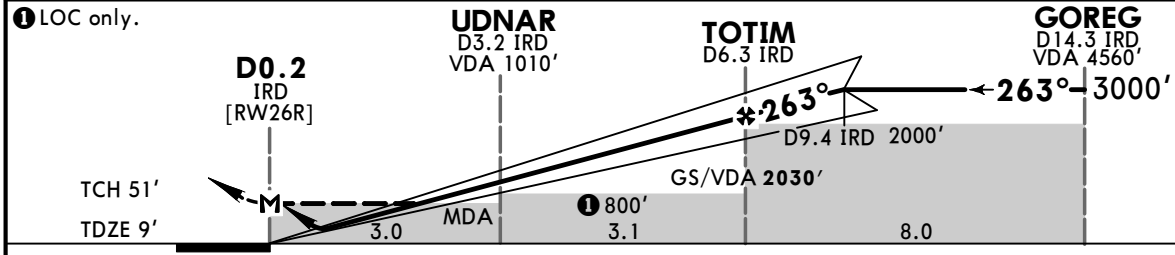

Gnd speed-Kts	70	90	100	120	140	160	ALSF-II PAPI 	420'	263° hdg	3000'	294° hdg
GS/VDA	3.00°	372	478	531	637	849			↑	RT	
MAP at D0.2 IRD											
TOTIM to MAP	6.1	5:14	4:04	3:40	3:03	2:37					

STRAIGHT-IN LANDING RWY26R			
ILS DME or ILS RADAR DA(H) 209' (200') FULL DA(H) 259' (250') HIALS out		LOC (GS out) DME or LOC (GS out) RADAR MDA(H) 600' (591') HIALS out	
A			
B	RVR 26 or 1/2	RVR 50 or 1	1 1/4
C			
D			

CYVR/YVR
VANCOUVER INTL

JEPPESEN
17 FEB 23
Eff 23 Feb **(11-5A)**

VANCOUVER, BC
ILS CAT II or III Rwy 26R

D-ATIS 124.6		PACIFIC Radio 123.15			VANCOUVER Arrival Outer 128.175 128.6 Inner 133.1 134.225			
VANCOUVER Tower North 119.55 124.025 125.65 South 118.7					Ground North 127.15 South 121.7			
LOC 111.95	Final Apch Crs 263°	GS TOTIM 2030' (2021')	CAT IIIC NA	CAT IIIB NA	CAT IIIA Refer to Minimums	CAT II ILS RA 106' DA(H) 109'(100')	Apt Elev 13' TDZE 9'	<p>MSA YVR VOR</p>
<p>MISSED APCH: Climb to 420' heading 263°. Then climbing RIGHT turn to 3000' heading 294°. Intercept outbound R-261 YPK VOR to DUTNO. Shuttle climb at DUTNO to 5300' before proceeding on course.</p>								
Alt Set: INCHES		Trans level: FL180			Trans alt: 18000'			
<p>1. Radar or RNAV required. 2. PRIOR AUTHORIZATION REQUIRED FROM TRANSPORT CANADA. 3. SAFE ALTITUDE WITHIN 100 NM 12,800'. 4. Procedure turn NOT AUTHORIZED. 5. Simultaneous approach AUTHORIZED with Rwy 26L. 6. LOC reliable only within 10° either side of centerline.</p>								

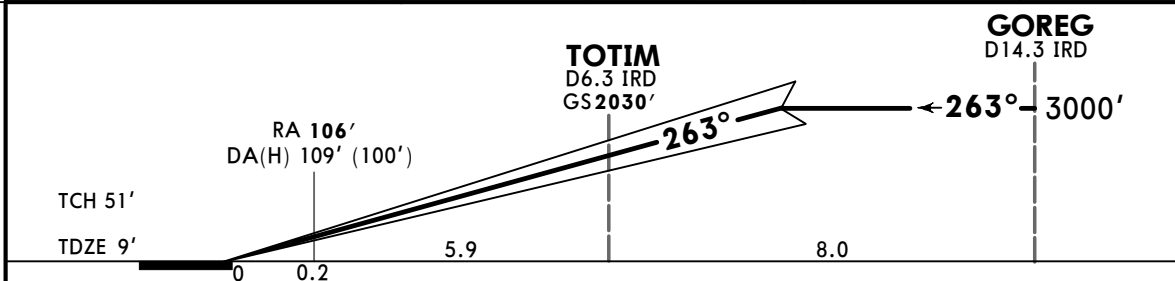
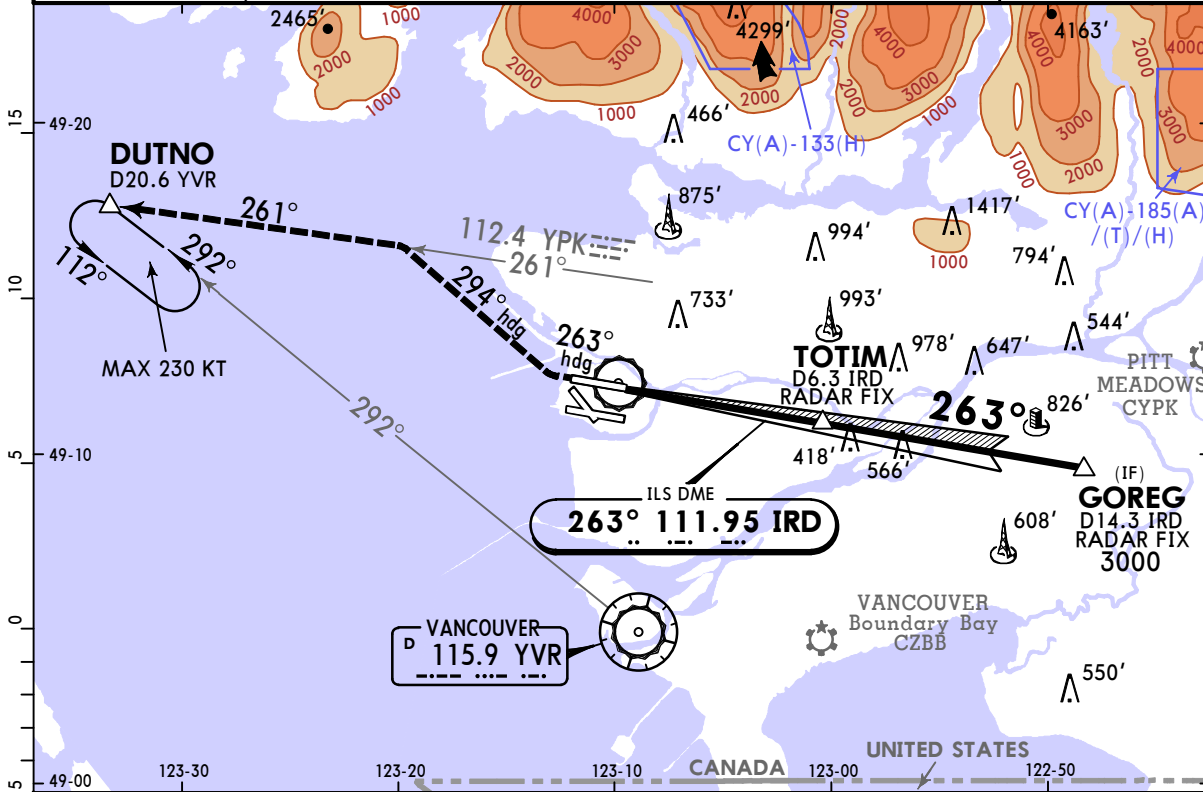

Gnd speed-Kts	70	90	100	120	140	160	ALSF-II	420'	263° hdg	3000'	294° hdg
GS	3.00°	372	478	531	637	849					
							PAPI	↑		RT	

STRAIGHT-IN LANDING RWY 26R			
CAT IIIC ILS	CAT IIIB ILS	CAT IIIA ILS	CAT II ILS RA 106' DA(H) 109'(100')
NOT AUTHORIZED	NOT AUTHORIZED	RVR 6	RVR 12

CYVR/YVR
VANCOUVER INTL

JEPPESEN
17 FEB 23
Eff 23 Feb (12-1)

VANCOUVER, BC
RNAV (GNSS) Z Rwy 08L

D-ATIS 124.6		PACIFIC Radio 123.15		VANCOUVER Arrival Outer 128.175 128.6		Inner 133.1 134.225			
VANCOUVER Tower North 119.55 124.025				South 125.65 118.7					
WAAS Ch 80712 W-08A		Final Apch Crs 083°		GPA OMRAD 2000' (1987')		LPV DA(H) Refer to Minimums			
Apt Elev 13'		Rwy 13'							
MISSED APCH: Do not exceed 230 KT until SESPI. Climbing LEFT turn to 3000' direct to SESPI. As required shuttle climb.									
Alt Set: INCHES		Trans level: FL180						Trans alt: 18000'	
1. SAFE ALTITUDE WITHIN 100 NM 12,800'. 2. Simultaneous approach AUTHORIZED with Rwy 08R. 3. LNAV procedure NOT AUTHORIZED during simultaneous operations. 4. Advise ATC if unable to conduct LPV or LNAV/VNAV approach. 5. For uncompensated Baro-VNAV systems, LNAV/VNAV not authorized below -18°C (0°F) or above 54°C (129°F).									

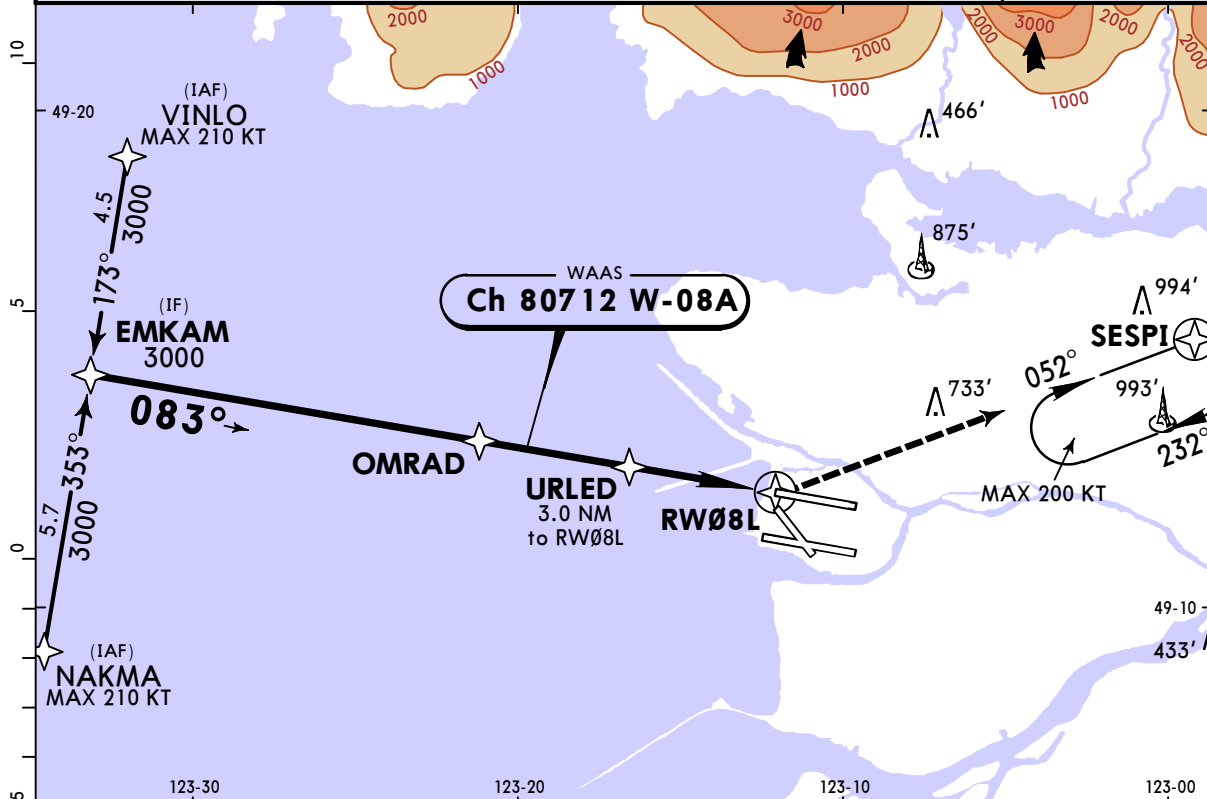

NM to RW08L	14.1	12.0	11.0	10.0	9.2	8.0	7.0	6.0	5.0	4.0	3.0	2.0	1.0
VDA ALTITUDE	4560'	3890'	3570'	3250'	3000'	2620'	2300'	1980'	1660'	1340'	1020'	700'	380'

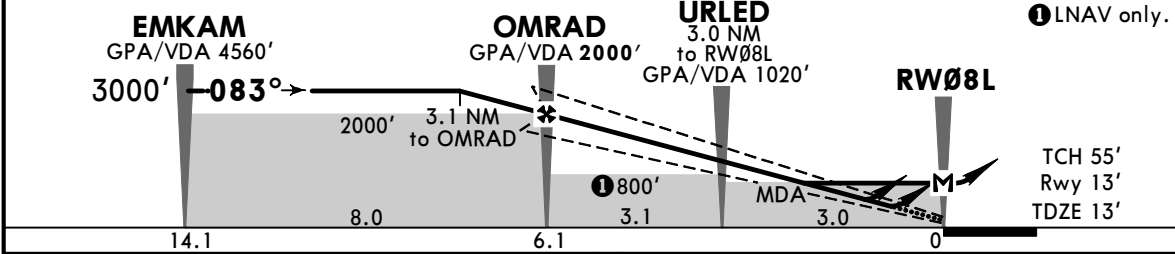

Gnd speed-Kts	70	90	100	120	140	160	ALSF-II PAPI 230 KT MAX UNTIL SESPI	3000' LT		SESPI
GPA/VDA	3.00°	372	478	531	637	849				
MAP at RW08L										

STRAIGHT-IN LANDING RWY 08L				
LPV DA(H) 213' (200')		LNAV/VNAV DA(H) 329' (316')		LNAV MDA(H) 380' (367')
HIALS out		HIALS out		HIALS out
A				
B	RVR 26 or 1/2	RVR 50 or 1	RVR 50 or 1	RVR 50 or 1
C				1/4
D				

CYVR/YVR
VANCOUVER INTL

JEPPESEN
17 FEB 23 (12-2) Eff 23 Feb

VANCOUVER, BC
RNAV (GNSS) Rwy 08R

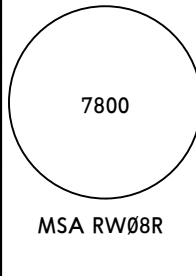
D-ATIS 124.6		PACIFIC Radio 123.15		VANCOUVER Arrival Outer 128.175 128.6		Inner 133.1 134.225			
VANCOUVER Tower North 119.55 124.025 125.65				South 118.7					
WAAS Ch 80922 W-08B		Final Apch Crs 083°		GPA TAVPI 2000' (1991')		LPV DA(H) Refer to Minimums			
				Apt Elev 13' Rwy 9'					
MISSED APCH: Do not exceed 200 KT until MOGIG. Climb to 600' heading 083°. Climbing RIGHT turn to 2000' direct to UKREL. Then track 196° to MOGIG. Shuttle climb at MOGIG to 5200' before proceeding on course.									
Alt Set: INCHES		Trans level: FL180		Trans alt: 18000'					
1. SAFE ALTITUDE WITHIN 100 NM 12,800'. 2. Simultaneous approach AUTHORIZED with Rwy 08L. 3. LNAV procedure NOT AUTHORIZED during simultaneous operations. 4. Advise ATC if unable to conduct LPV or LNAV/VNAV approach. 5. For uncompensated Baro-VNAV systems, LNAV/VNAV not authorized below -18°C (0°F) or above 54°C (129°F).									

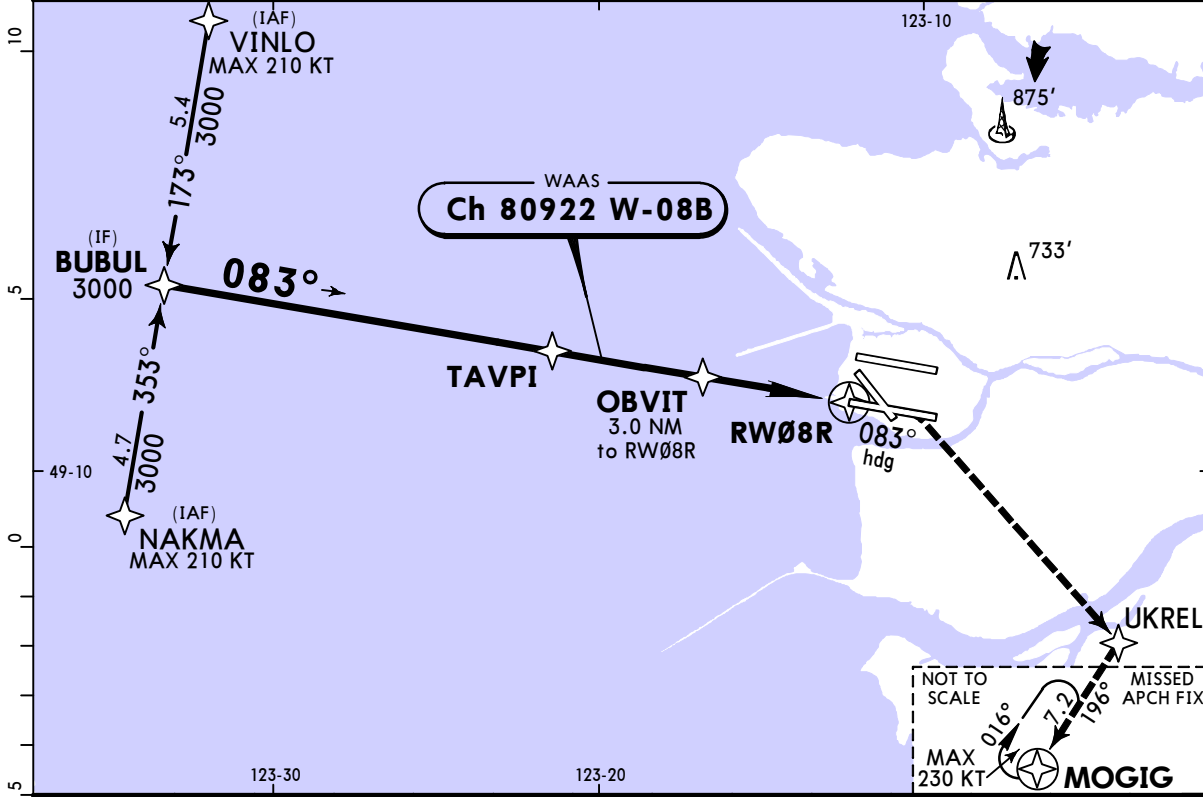

NM to RW08R	14.0	12.0	11.0	10.0	9.2	8.0	7.0	6.0	5.0	4.0	3.0	2.0	1.0
VDA ALTITUDE	4530'	3890'	3570'	3250'	3000'	2610'	2290'	1980'	1660'	1340'	1020'	700'	380'

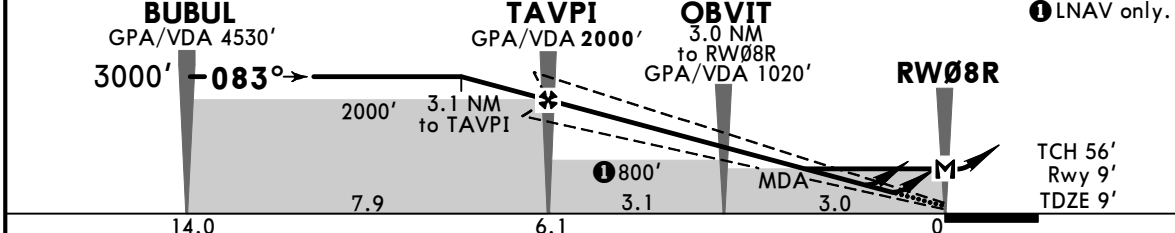

Gnd speed-Kts	70	90	100	120	140	160	ALSF-II PAPI 200 KT MAX UNTIL MOGIG	600' ↑	083° hdg	2000' RT	UKREL
GPA/VDA	3.00°	372	478	531	637	849					
MAP at RW08R											

STRAIGHT-IN LANDING RWY 08R				
LPV DA(H) 209' (200')		LNAV/VNAV DA(H) 283' (274')		LNAV MDA(H) 380' (371')
HIALS out		HIALS out		HIALS out
A				
B	RVR 26 or 1/2	RVR 50 or 1	RVR 50 or 1	RVR 50 or 1
C				1 1/4
D				

CHANGES: Procedure revised.

CYVR/YVR VANCOUVER INTL

JEPPESSEN
17 FEB 23 **(12-3)** Eff 23 Feb

VANCOUVER, BC RNAV (GNSS) Rwy 13

D-ATIS 124.6		PACIFIC Radio 123.15		VANCOUVER Arrival Outer 128.175 128.6		Inner 133.1 134.225					
VANCOUVER Tower North 119.55 124.025 125.65 118.7				Ground North 127.15				South 121.7			
WAAS Ch 80550 W-13A		Final Apch Crs 125°		GPA UDLEM 2300' (2292')		LPV DA(H) 258' (250')		Apt Elev 13' Rwy 8'			
MISSED APCH: Climb to 3000' track 125° to APGON. Shuttle to 5800' before proceeding on course.								 7800 MSA RW13			
Alt Set: INCHES				Trans level: FL180						Trans alt: 18000'	
1. SAFE ALTITUDE WITHIN 100 NM 12,800'. 2. RADAR required. 3. For uncompensated Baro-VNAV systems, LNAV/VNAV not authorized below -18°C (0°F) or above 54°C (129°F).											

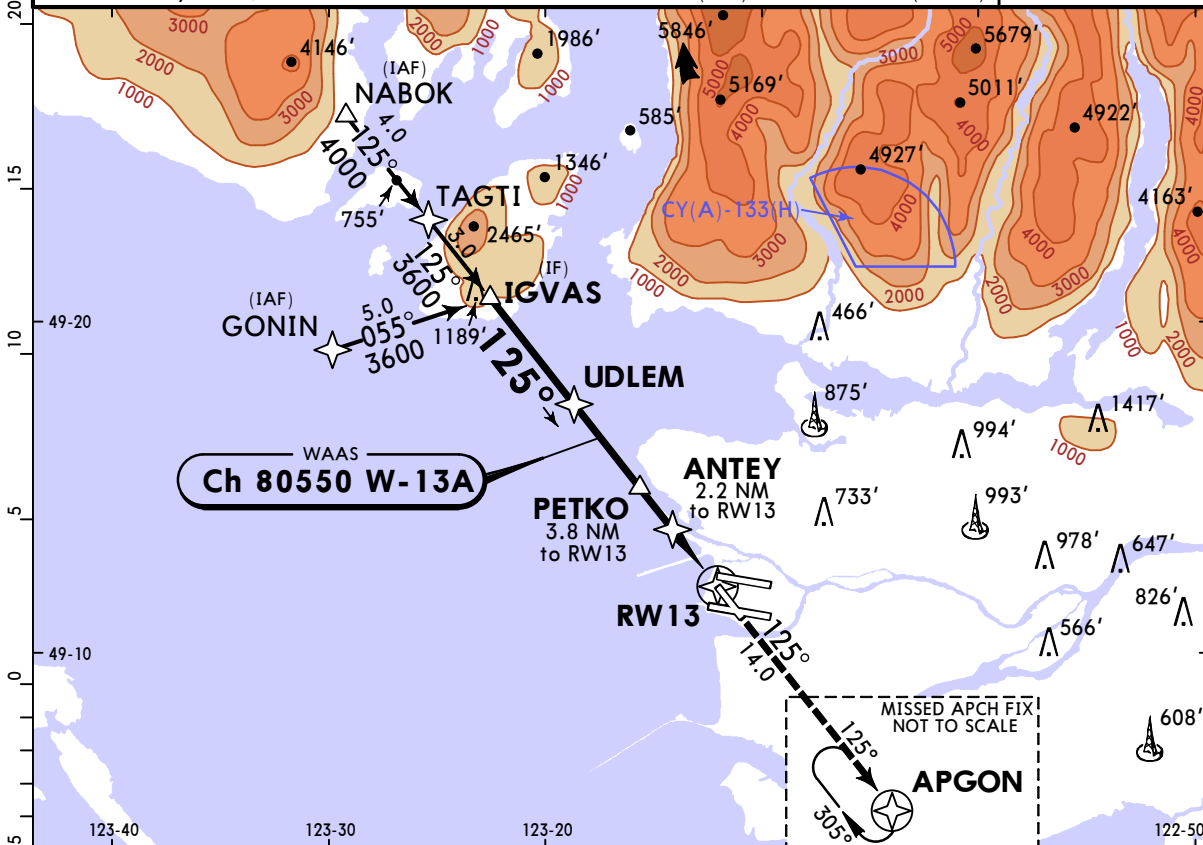

NM to RW13	11.1	10.0	9.0	8.0	7.0	6.0	5.0	4.0	3.0	2.0	1.1
VDA ALTITUDE	3600'	3250'	2930'	2610'	2290'	1970'	1660'	1340'	1020'	700'	400'

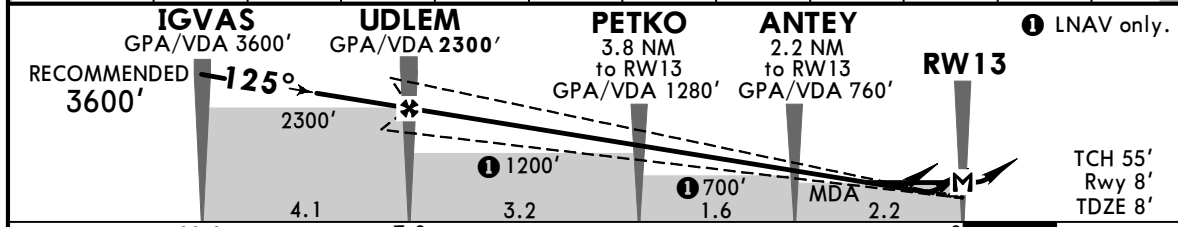

Gnd speed-Kts	70	90	100	120	140	160	ODALS		3000'		125° APGON	
GPA/VDA	3.00°	372	478	531	637	849	PAPI		↑			
MAP at RW13												

STRAIGHT-IN LANDING RWY 13			
LPV	LNAV/VNAV		LNAV
DA(H) 258' (250')	DA(H) 330' (322')		MDA(H) 400' (392')
ALS out	ALS out		ALS out

A				
B	1		1	
C			1 1/4	
D				

CHANGES: None.

CYVR/YVR
VANCOUVER INTL

JEPPesen
17 FEB 23 (12-4) Eff 23 Feb

VANCOUVER, BC
RNAV (GNSS) Rwy 26L

BRIEFING STRIP™	D-ATIS 124.6		PACIFIC Radio 123.15		VANCOUVER Arrival				
					Outer 128.175 128.6		Inner 133.1 134.225		
	VANCOUVER Tower				Ground				
	North 119.55		South 125.65		North 127.15		South 121.7		
WAAS Ch 81035 W-26B		Final Apch Crs 263°		GPA DUTOM 2000' (1993')		LPV DA(H) Refer to Minimums		Apt Elev 13' Rwy 7'	
MISSED APCH: Climb to 600' heading 263°. Then climbing LEFT turn to 2000' direct to MEBUD. Shuttle climb at MEBUD to 5100' before proceeding on course.								 7800 MSA RW26L	
Alt Set: INCHES		Trans level: FL180				Trans alt: 18000'			
1. SAFE ALTITUDE WITHIN 100 NM 12,800'. 2. Simultaneous approach AUTHORIZED with Rwy 26R. 3. LNAV procedure NOT AUTHORIZED during simultaneous operations. 4. Advise ATC if unable to conduct LPV or LNAV/VNAV approach. 5. For uncompensated Baro-VNAV systems, LNAV/VNAV not authorized below -17°C (1°F) or above 54°C (129°F).									



NM to RW26L	1.4	2.0	3.0	4.0	5.0	6.0	7.0	8.0	9.2	10.0	11.0	12.0	14.0
VDA ALTITUDE	520'	700'	1020'	1340'	1660'	1980'	2300'	2610'	3000'	3250'	3570'	3890'	4530'

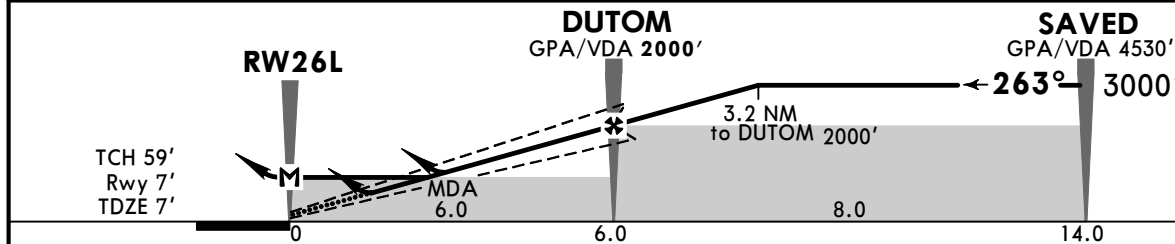

Gnd speed-Kts	70	90	100	120	140	160	ALSIF-II PAPI	600'	263° hdg	2000'	MEBUD
GPA/VDA	3.00°	372	478	531	637	849					
MAP at RW26L											

STRAIGHT-IN LANDING RWY 26L					
LPV		LNAV/VNAV		LNAV	
DA(H) 207' (200')		DA(H) 257' (250')		DA(H) 566' (559')	
HIALS out		HIALS out		HIALS out	
A					
B	RVR 26 or 1/2	RVR 50 or 1	1 1/2	1 3/4	RVR 50 or 1
C					
D					

CHANGES: Procedure revised.

© JEPPESEN, 2015, 2023. ALL RIGHTS RESERVED.

CYVR/YVR VANCOUVER INTL

JEPPESEN
17 FEB 23 **(12-5) Eff 23 Feb**

VANCOUVER, BC RNAV (GNSS) Rwy 26R

D-ATIS 124.6		PACIFIC Radio 123.15		VANCOUVER Arrival Outer 128.175 128.6		Inner 133.1 134.225		
VANCOUVER Tower North 119.55 124.025 125.65				South 118.7				
North 127.15		Ground 121.7		South 121.7				
WAAS Ch 80687 W-26A	Final Apch Crs 263°	GPA TOTIM 2000' (1991')	LPV DA(H) Refer to Minimums	Apt Elev 13' Rwy 9'		7800 MSA RW26R		
MISSED APCH: Do not exceed 230 KT until DUTNO. Climb to 700' heading 263°. Climbing RIGHT turn to 3000' direct to KEDGA. Then climb track 245° to DUTNO. Shuttle climb at DUTNO to 5300' before proceeding on course.								
Alt Set: INCHES		Trans level: FL180		Trans alt: 18000'				
1. SAFE ALTITUDE WITHIN 100 NM 12,800'. 2. Simultaneous approach AUTHORIZED with Rwy 26L. 3. LNAV procedure NOT AUTHORIZED during simultaneous operations. 4. Advise ATC if unable to conduct LPV or LNAV/VNAV approach. 5. For uncompensated Baro-VNAV systems, LNAV/VNAV not authorized below -18°C (0°F) or above 54°C (129°F).								



NM to RW26R	1.7	2.0	3.0	4.0	5.0	6.0	7.0	8.0	9.2	10.0	11.0	12.0	14.1
VDA ALTITUDE	600'	700'	1020'	1330'	1650'	1970'	2290'	2610'	3000'	3250'	3560'	3880'	4560'

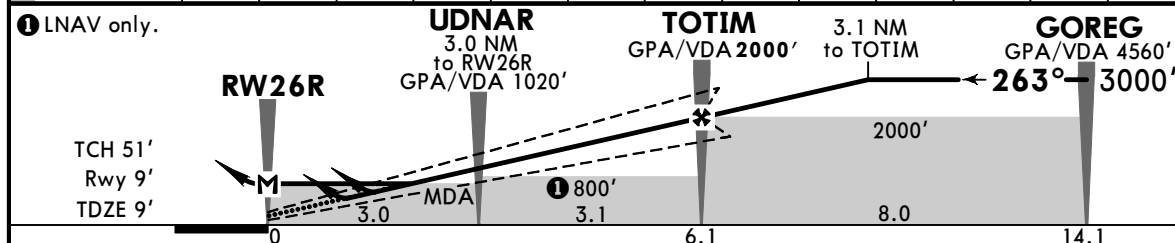

Gnd speed-Kts	70	90	100	120	140	160	ALSF-II PAPI	230 KT MAX UNTIL DUTNO	700' ↑	263° hdg
GPA/VDA	3.00°	372	478	531	637	849				
MAP at RW26R										

STRAIGHT-IN LANDING RWY 26R					
LPV		LNAV/VNAV		LNAV	
DA(H) 209' (200')	DA(H) 259' (250')	DA(H) 567' (558')		MDA(H) 600' (591')	
HIALS out		HIALS out		HIALS out	
A					
B	RVR 26 or 1/2	RVR 50 or 1	1 1/2	1 3/4	1 3/4
C					
D					

CHANGES: Procedure revised.

CYVR/YVR
VANCOUVER INTL



17 FEB 23 **(12-6)** Eff 23 Feb

VANCOUVER, BC
RNAV (GNSS) Rwy 31

BRIEFING STRIP™	D-ATIS 124.6		PACIFIC Radio 123.15		VANCOUVER Arrival						
					Outer 128.175 128.6		Inner 133.1 134.225				
	VANCOUVER Tower				Ground						
	North 119.55		South 125.65		North 127.15		South 121.7				
WAAS Ch 80139 W-31A		Final Apch Crs 305°		GPA KEKTU 2000' (1993')		LPV DA(H) 257' (250')		Apt Elev 13' Rwy 7'			
MISSED APCH: Climb track 305° to TEVAK, then climbing LEFT turn to 3000' track 275° to NUTBE. Shuttle to 5600' before proceeding on course.								 7800 MSA RW31			
Alt Set: INCHES				Trans level: FL180		Trans alt: 18000'					
1. SAFE ALTITUDE WITHIN 100 NM 12,800'. 2. For uncompensated Baro-VNAV systems, LNAV/VNAV not authorized below -18°C (0°F) or above 54°C (129°F).											

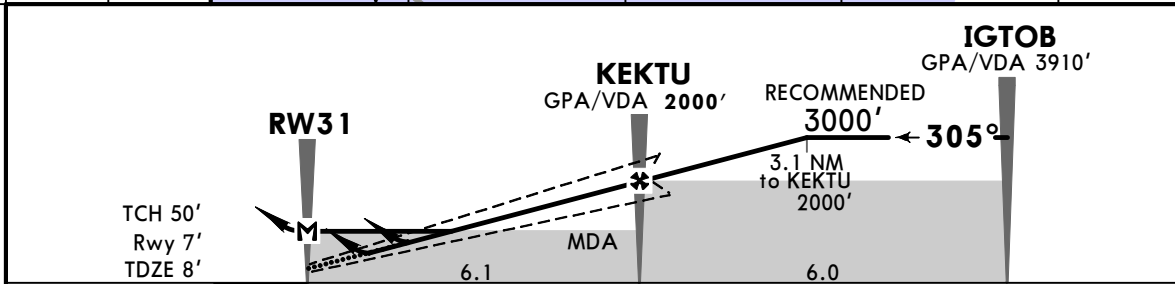

Gnd speed-Kts	70	90	100	120	140	160	ODALS PAPI ↑ 305°	TEVAK
GPA/VDA	3.00°	372	478	531	637	849		
MAP at RW31								

STRAIGHT-IN LANDING RWY 31			
LPV DA(H) 257' (250') ALS out		LNAV/VNAV DA(H) 353' (346') ALS out	
		LNAV MDA(H) 540' (533') ALS out	
A			
B			
C	1	1¼	1¾
D			

CHANGES: None.

CYVR/YVR
VANCOUVER INTL

JEPPESSEN
14 APR 23
Eff 20 Apr (12-20)

VANCOUVER, BC
RNAV (RNP) Y Rwy 08L

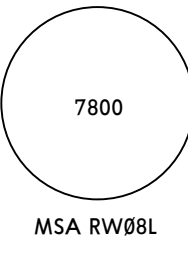
D-ATIS 124.6		PACIFIC Radio 123.15		VANCOUVER Arrival Outer 128.17 128.6		Inner 133.1 134.225				
VANCOUVER Tower North 119.55				South 118.7		Ground North 127.15		South 121.7		
RNAV	Final Apch Crs 083°	Minimum Alt IMITU 1300' (1287')	RNP 0.15 DA(H) 302' (289')	Apt Elev 13'	TDZE 13'	 <p>7800 MSA RW08L</p>				
MISSED APCH: Climb to 420' heading 083°. Then climbing LEFT turn to 3500' direct to UKNOS. Then climb track 084° to YPK VOR.										
Alt Set: INCHES		Trans level: FL180		Trans alt: 18000'						
1. AUTHORIZATION REQUIRED. 2. SAFE ALTITUDE WITHIN 100 NM 12,800'. 3. Simultaneous approach AUTHORIZED with Rwy 08R. 4. For uncompensated Baro-VNAV systems, procedure not authorized below -20°C (-4°F) or above 54°C (129°F).										

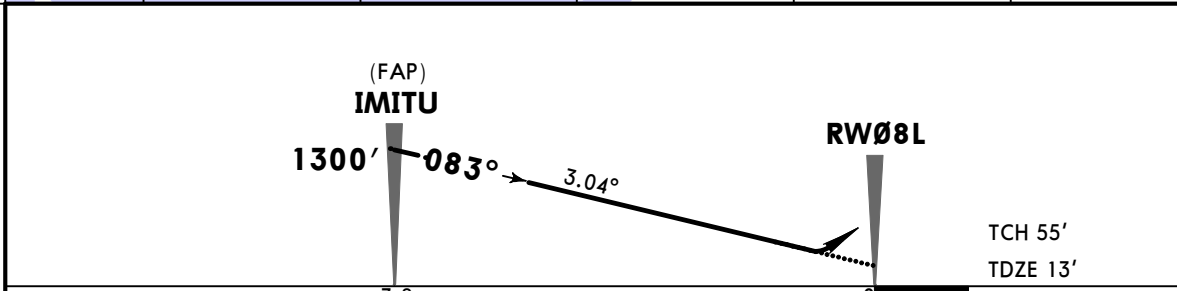
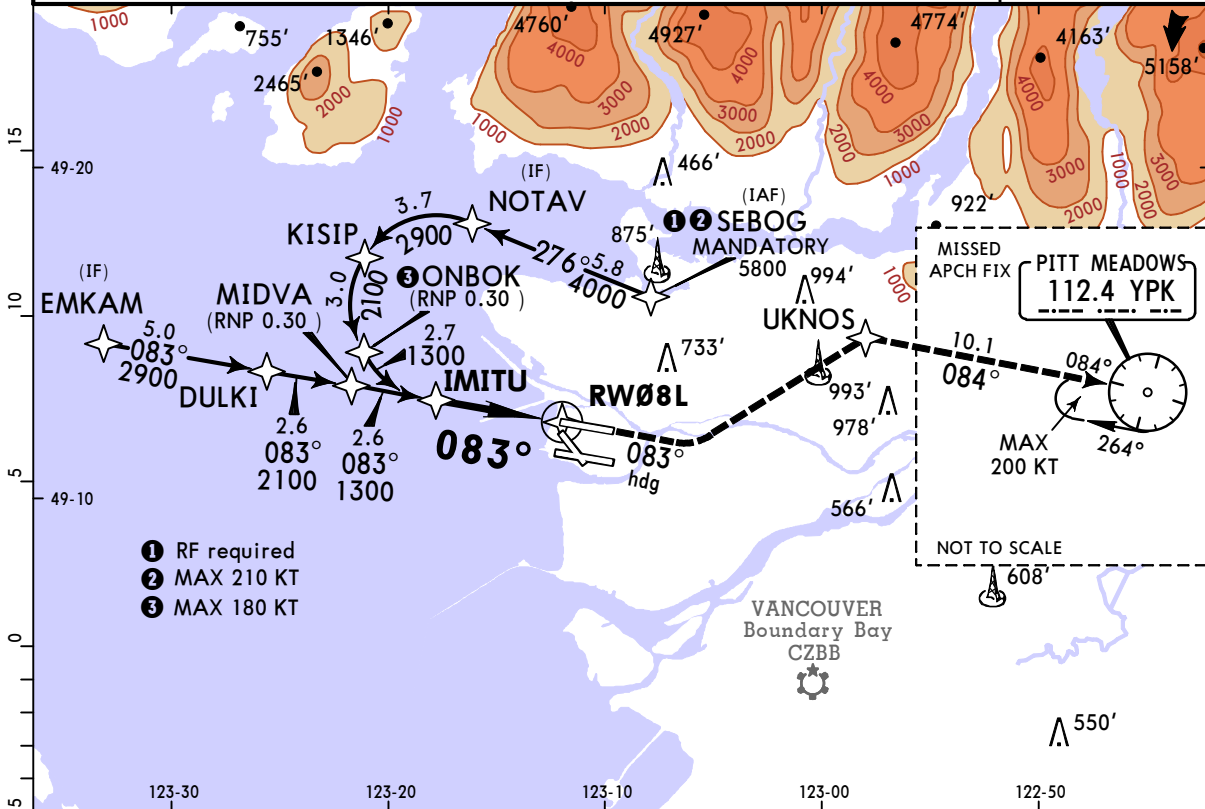

Gnd speed-Kts	70	90	100	120	140	160	ALSF-II PAPI	420'	083° hdg	3500'	UKNOS LT
Descent Angle	3.04°	376	484	538	645	753		861			

STRAIGHT-IN LANDING RWY 08L			
RNP 0.15 DA(H) 302' (289')		RNP 0.30 DA(H) 334' (321')	
HIALS out		HIALS out	

A	RVR 50 or 1	RVR 50 or 1
B		
C		
D		

CHANGES: Waypoint ident, speed restriction changed.

General Information

Location: TORONTO ON CAN
ICAO/IATA: CYYZ / YYZ
Lat/Long: N43° 40.6', W079° 37.8'
Elevation: 569 ft

Airport Use: Public
Daylight Savings: Observed
UTC Conversion: +5:00 = UTC
Magnetic Variation: 10.0° W
Sectional Chart: Detroit

Fuel Types: Jet A, Jet A-1, Jet B
Oxygen Types: High Pressure, Low Pressure
Repair Types: Minor Airframe, Minor Engine, Major Airframe, Major Engine
Customs: Yes
Airport Type: IFR
Landing Fee: Yes
Control Tower: Yes
Jet Start Unit: Yes
LLWS Alert: No
Beacon: No

Sunrise: 1045 Z
Sunset: 2355 Z

Runway Information

Runway: 05
Length x Width: 11120 ft x 200 ft
Surface Type: asphalt
TDZ-Elev: 564 ft
Lighting: Edge, ALS, Centerline, TDZ
Displaced Threshold: 135 ft

Runway: 06L
Length x Width: 9697 ft x 197 ft
Surface Type: asphalt
TDZ-Elev: 535 ft
Lighting: Edge, ALS, Centerline, TDZ

Runway: 06R
Length x Width: 9000 ft x 197 ft
Surface Type: asphalt
TDZ-Elev: 538 ft
Lighting: Edge, ALS, Centerline

Runway: 15L
Length x Width: 11050 ft x 200 ft
Surface Type: asphalt
TDZ-Elev: 557 ft
Lighting: Edge, ALS, Centerline

Runway: 15R
Length x Width: 9088 ft x 197 ft
Surface Type: asphalt
TDZ-Elev: 552 ft
Lighting: Edge, ALS
Displaced Threshold: 588 ft

Runway: 23
Length x Width: 11120 ft x 200 ft
Surface Type: asphalt
TDZ-Elev: 558 ft
Lighting: Edge, ALS, Centerline
Displaced Threshold: 686 ft

Runway: 24L
Length x Width: 9000 ft x 197 ft
Surface Type: asphalt
TDZ-Elev: 547 ft
Lighting: Edge, ALS, Centerline

Runway: 24R
Length x Width: 9697 ft x 197 ft
Surface Type: asphalt
TDZ-Elev: 546 ft
Lighting: Edge, ALS, Centerline, REIL, TDZ
Displaced Threshold: 197 ft

Runway: 33L
Length x Width: 9088 ft x 197 ft
Surface Type: asphalt
TDZ-Elev: 548 ft
Lighting: Edge, ALS
Displaced Threshold: 588 ft

Runway: 33R
Length x Width: 11050 ft x 200 ft
Surface Type: asphalt
TDZ-Elev: 564 ft
Lighting: Edge, ALS, Centerline

Communication Information

ATIS: 133.100

ATIS: 120.825

Toronto Tower: 118.700

Toronto Tower: 118.350

Toronto Ground: 121.900

Toronto Ground: 119.100

Toronto Ground: 121.650

Toronto Apron Ramp/Taxi: 122.075

Toronto Apron Ramp/Taxi: 122.275

Toronto Apron Ramp/Taxi: 122.825 Secondary

Toronto Clearance Delivery: 121.300

Toronto Arrival: 132.800

Toronto Arrival: 125.400

Toronto Arrival: 124.475

Toronto Departure: 127.575

Toronto Departure: 128.800

Toronto Terminal Area: 119.300

Toronto Terminal Area: 133.400

Tow Coordinator Operations: 136.525

Pad Control Operations: 131.950

A-Cdm Coordinator Operations: 122.875

Pad Control Operations: 131.175

Iceman Operations: 129.625

Iceman Operations: 131.375

A-Cdm Coordinator Operations: 122.825 Secondary

London Radio Radio: 123.275 Flight Info Service RCO

CYYZ/YYZ

LESTER B PEARSON INTL

JEPPESEN

28 APR 23

10-1P

TORONTO, ONT

AIRPORT BRIEFING

AIRPORT COLLABORATIVE DECISION MAKING (A-CDM) PROCEDURES

1.0. DATE OF APPLICABILITY

- A-CDM live operations will be effective as of 05 April 2021

2.0. PURPOSE OF THE PUBLICATION

This information outlines the A-CDM procedures to be followed by operators at CYYZ. Additional information on the details of the A-CDM Project at CYYZ can be found at: <http://torontopearson.com/acdm/>.

For anything not covered in this circular, detailed explanation can be found in the Transport Canada Aeronautical Information Manual (TC AIM), Aerodromes chapter, section 10: https://www.tc.gc.ca/ca-publications/AIM_2020-1_E_AGA.pdf.

The A-CDM web portal for operational purposes can be found at: <https://acdm.gtaa.com/>.

3.0. A-CDM SINGLE POINT OF CONTACT

The 24/7 dedicated single point of contact for A-CDM is the Manager Operations - Airport Flow (MO-AF):

Tel.: 416-776-ACDM (2236)
E-mail: manageroperationsairportflow@gtaa.com

4.0. EXEMPTIONS FROM A-CDM PROCEDURES

Helicopters and flights identified by any one of the following designators in Item 18 of their flight plan, or by any other agreed means that may be applicable, are exempt from adhering to the A-CDM procedures:

STS/FFR	Fire fighting
STS/HEAD	Flight with Head of State status
STS/HOSP	Flight on an actual medical mission
STS/MEDEVAC	Flight operated for life critical medical emergency evacuation
STS/SAR	Flight engaged in a search and rescue mission
STS/STATE	Flight engaged in military, customs or police services
STS/FLTCK	Aircraft performing NAVAID flight check

5.0. FLIGHT CREW PROCEDURES

5.1. ADHERENCE TO TOBT/TSAT

To prevent unnecessary, and potentially significant delays, flight crews are reminded of the importance of keeping their Target Off Blocks Time (TOBT) accurate. Failure to comply with the actions associated with TOBT/Target Start-up Approval Time (TSAT) will result in new times being allocated.

5.2. TOBT/TSAT VISIBILITY

- Where Advanced Visual Docking Guidance System (AVDGS) is available TSAT times will be displayed at TOBT - 10 minutes, or TOBT - 20 minutes if TSAT time is greater than or equal to TOBT + 20 minutes.
- A-CDM web portal: <https://acdm.gtaa.com/>.
- Through communication with the operator and their designated representative(s).

5.3. CALL READY PROCEDURE

- TOBT +/- 5 minutes contact Apron Coordinator to confirm that the flight is ready with aircraft location.
- Monitor appropriate Apron frequency to await push-back and start-up approval.

CYYZ/YYZ

LESTER B PEARSON INTL

 28 APR 23 (10-1P1)TORONTO, ONT
AIRPORT BRIEFING

5.4. PUSH-BACK/START-UP APPROVAL

- TSAT +/- 5 minutes Apron will provide push-back and start-up approval without a call from the flight crew.
- Sky Service midfield/3 Bay Hangar Apron aircraft shall start-up without requiring an instruction to do so from Apron in the TSAT +/- 5 minute window.
- Aircraft located at uncontrolled areas (Taxiway K, South FBO, Vista Cargo, Air Canada Hangar) shall contact North or South Ground as appropriate in the TSAT +/- 5 minute window for taxi clearance.
- Failure to commence the push-back/start-up process within 2 minutes must be reported to the appropriate Apron or Ground frequency. Failure to report will be assumed that the TSAT is no longer valid and the operator needs to provide a new TOBT from which a new TSAT will be generated.
- If there is an issue after the aircraft has cleared the gate area that would mean a longer than normal start-up procedure, flight crew must request guidance from Apron frequency or Apron Coordinator if located at uncontrolled areas.

5.5. DE-ICING OPERATIONS

De-icing procedures will have a significant impact on taxi times, airport throughput and A-CDM planning.

- De-icing requirements must be communicated to Clearance Delivery.
- Requests for a change in de-icing requirements (including no longer requiring de-icing) later in the process must be communicated to Apron Coordinator as soon as practicable.

5.6. MANAGING TSAT DELAYS

Delays can occur for many different reasons so there will be occasion when there is a significant time difference between TOBT and TSAT.

Flight crews at CYYZ can normally expect to remain at the gate whilst waiting for their TSAT. Should the gate be required for another purpose, flight crews can expect to remote hold on the airfield to await their TSAT.

Flow restrictions enroute, or at destination airports, are calculated into a flight's TSAT.

6.0. CONTINGENCY OPERATIONS

If the A-CDM system fails or becomes unreliable, the A-CDM procedures will be suspended. The suspension and eventual restarting of the procedures will be announced via the automatic terminal information service (ATIS) broadcast and a NOTAM.

During suspension of the A-CDM procedures, no TOBT and TSAT will be provided.

All aircraft are to report ready with Apron Coordinator when they are ready to commence push-back/start-up procedures.

D-ATIS	120.825	133.1	Apt Elev	569
Alt Set: INCHES Trans level: FL180				
RNAV 1 - D/D/I or GNSS required				
1. Safe Altitude within 100 NM 4900. 2. Jet aircraft only. 3. For non GNSS equipped aircraft, YSB and YV DMEs must be operational.				

BOXUM 6 ARRIVAL
(BOXUM.BOXUM6)
(RWYS 05, 06L/R)

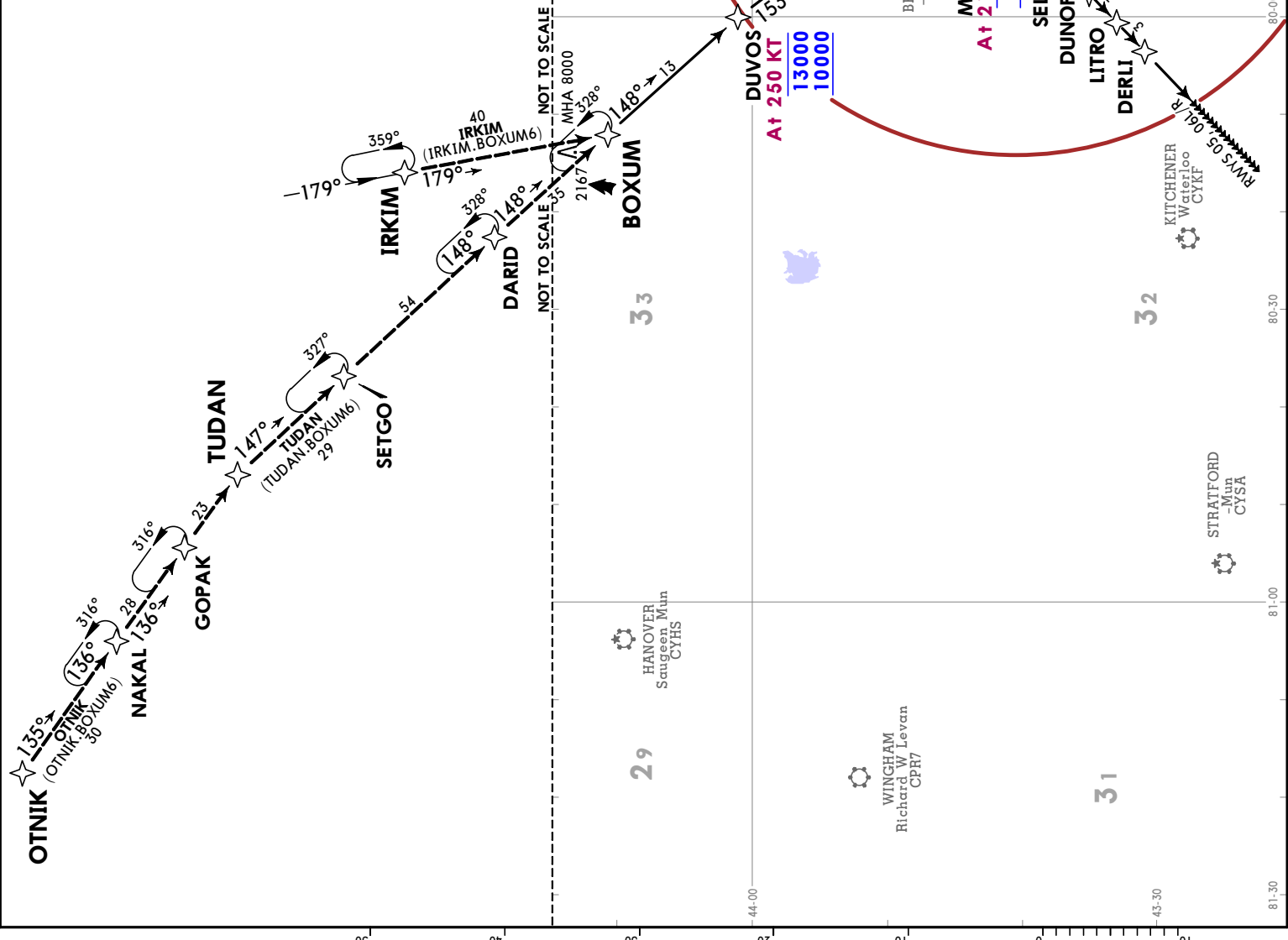

JEPPESEN
 28 APR 23 10-2A
CYYZ/YYZ
 LESTER B PEARSON INTL

TORONTO, ONT
RNAV STAR

D-ATIS	120.825	133.1	Apt Elev	569
Alt Set: INCHES Trans level: FL180				
RNAV 1 - D/D/I or GNSS required				
1. Safe Altitude within 100 NM 4900.				
2. Jet aircraft only.				
3. For non GNSS equipped aircraft, YSB and YV DMEs must be operational.				

BOXUM 6 ARRIVAL
(BOXUM.BOXUM6)
(RWYS 15L/R)

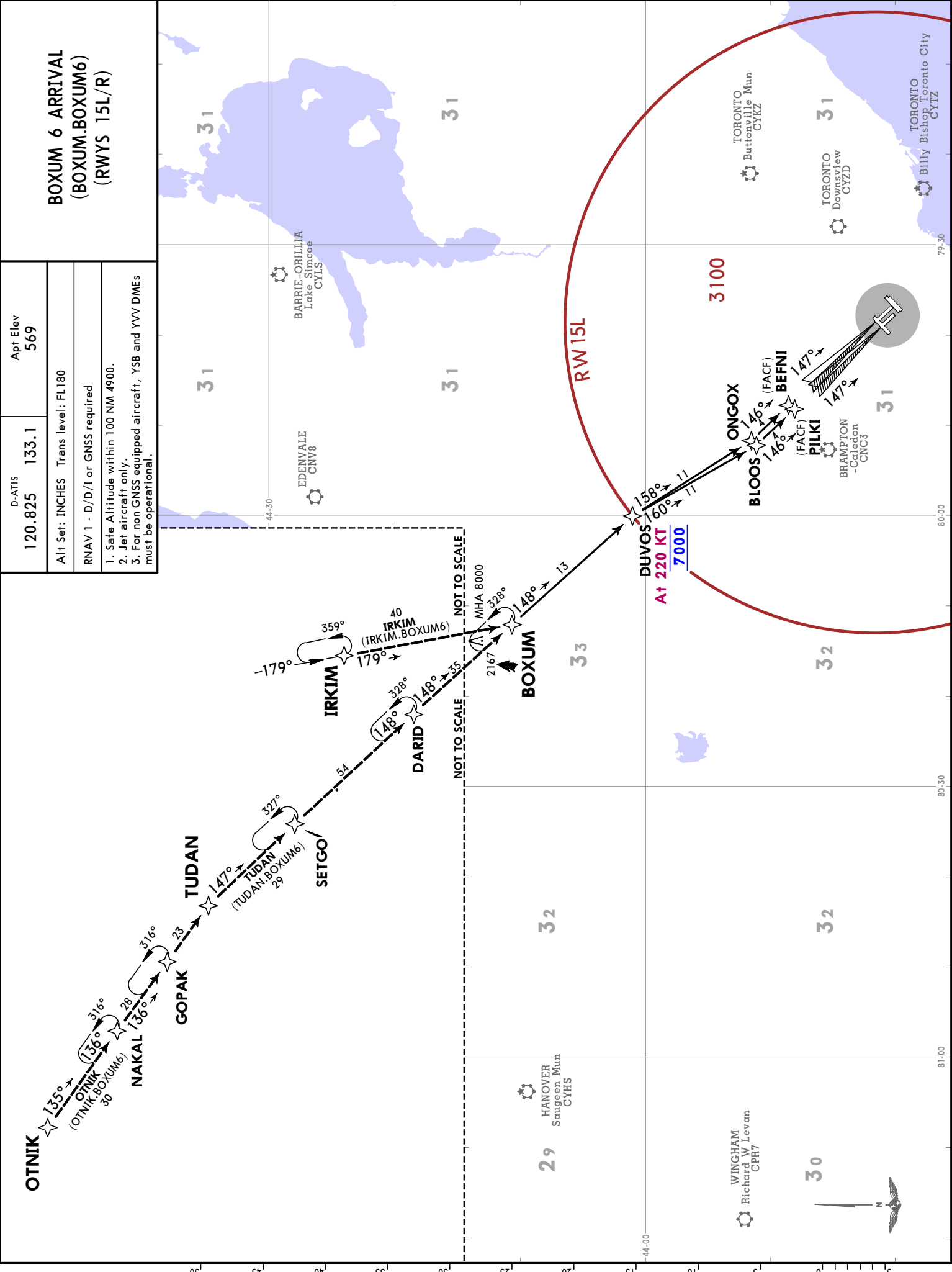

D-ATIS	120.825	133.1	Apt Elev	569
Alt Set: INCHES Trans level: FL180				
RNAV 1 - D/D/I or GNS required				
1. Safe Altitude within 100 NM 4900. 2. Jet aircraft only. 3. For non GNS equipped aircraft, YSB and YV DMEs must be operational.				

BOXUM 6 ARRIVAL
(BOXUM.BOXUM6)
(RWYS 23, 24L/R)

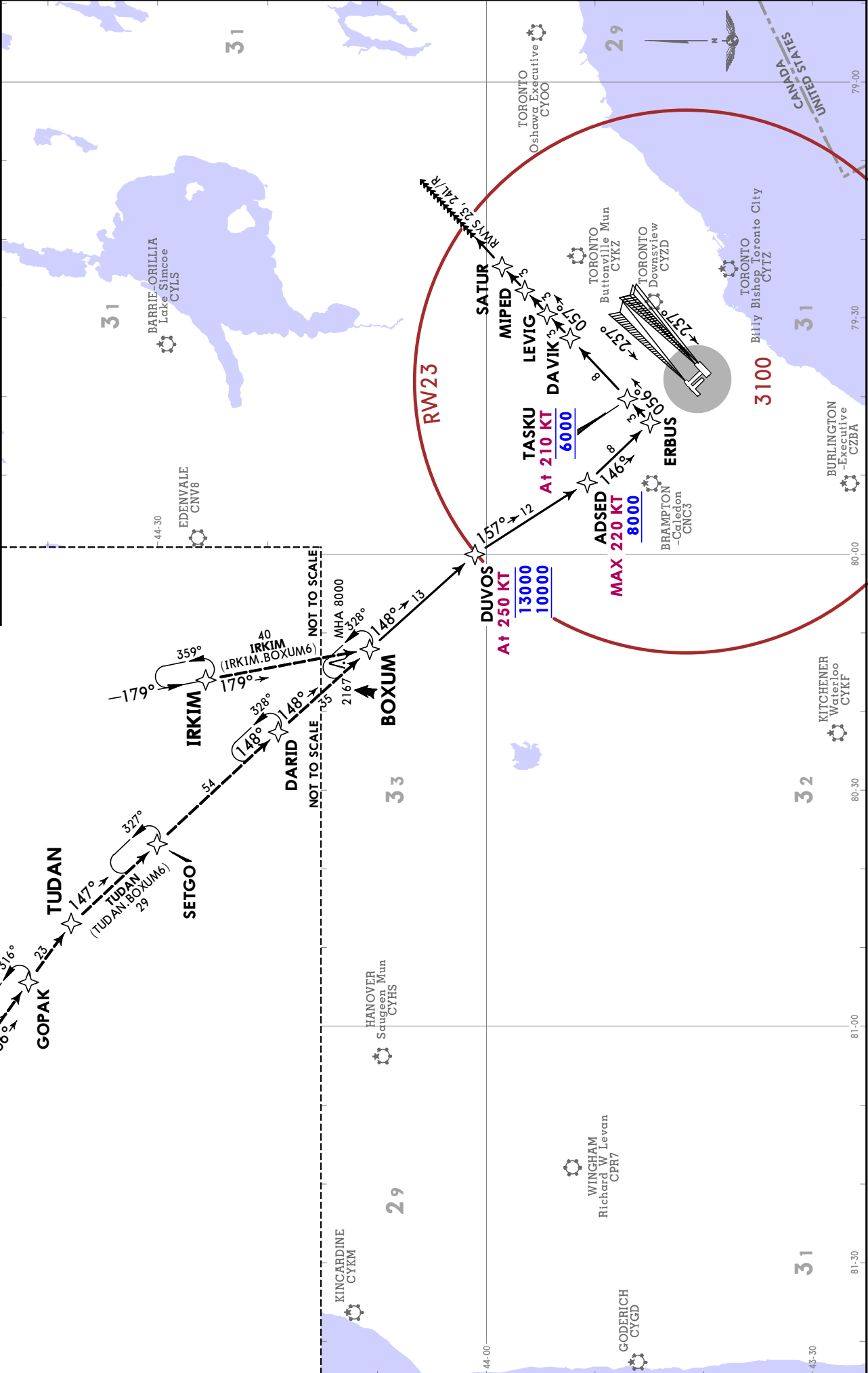

TORONTO, ONT
RNAV STAR

JEPPESSEN
 28 APR 23 (10-2A2)

CYYZ/YYZ
LESTER B PEARSON INTL

D-ATIS	120.825	133.1	Apt Elev	569
Alt Set: INCHES Trans level: FL180				
RNAV 1 - D/D/I or GNSS required				
1. Safe Altitude within 100 NM 4900. 2. Jet aircraft only. 3. For non GNSS equipped aircraft, YSB and YV DMEs must be operational.				

BOXUM 6 ARRIVAL
(BOXUM.BOXUM6)
(RWYS 33L/R)

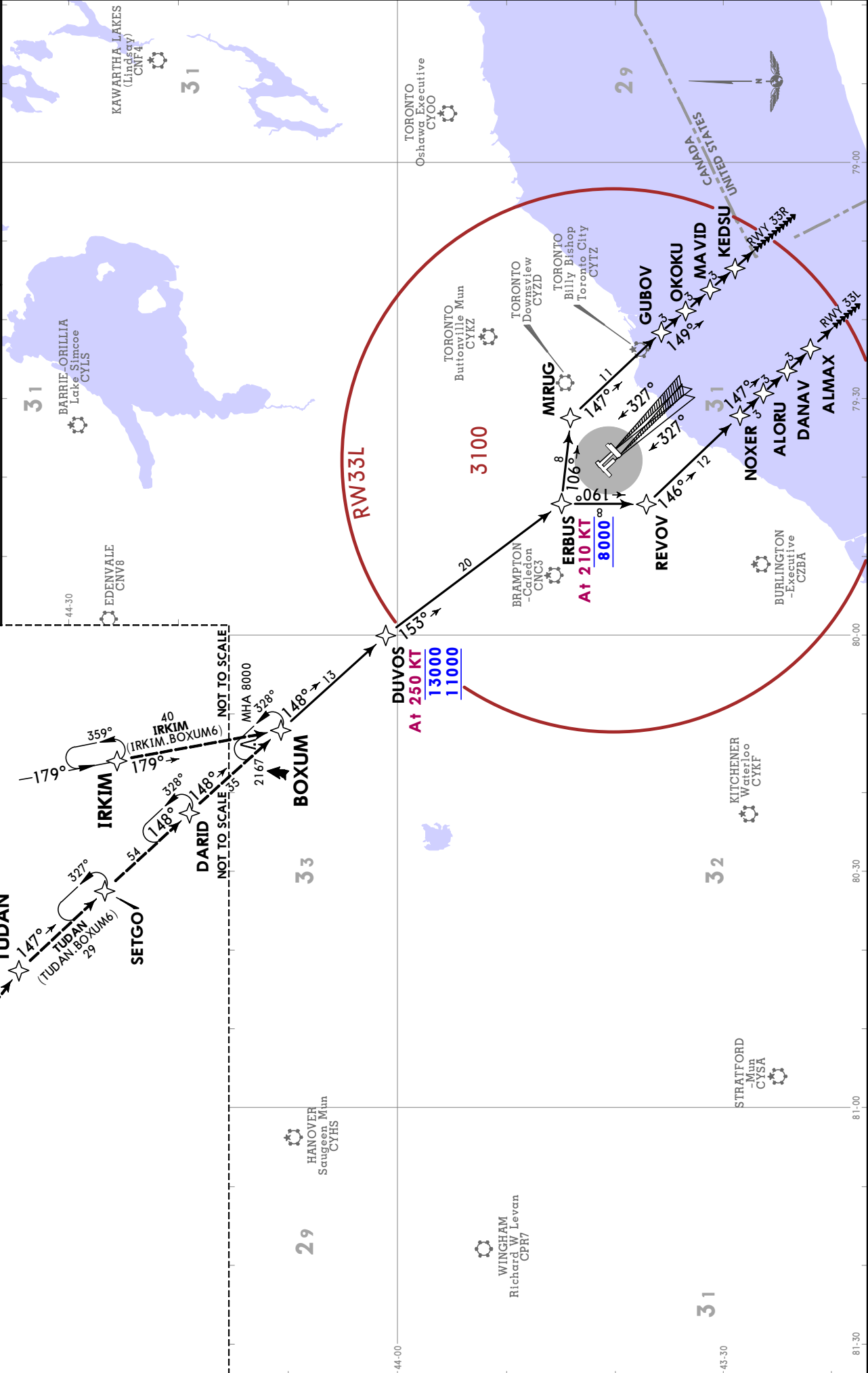

JEPPesen TORONTO, ONT
 28 APR 23 (10-2B) **RNAV STAR**

D-ATIS 120.825	133.1	Apt Elev 569	Alt Set: INCHES Trans level: FL180 RNAV 1 - D/D/1 or GNS3 required
1. Safe Altitude within 100 NM 4900. 2. Non-Jet aircraft only. 3. For non GNS3 equipped aircraft, YSB and YVW DMEs must be operational.			
DUVOS 4 ARRIVAL (BOXUM.DUVOS4) (RWYS 05, 06L/R)			

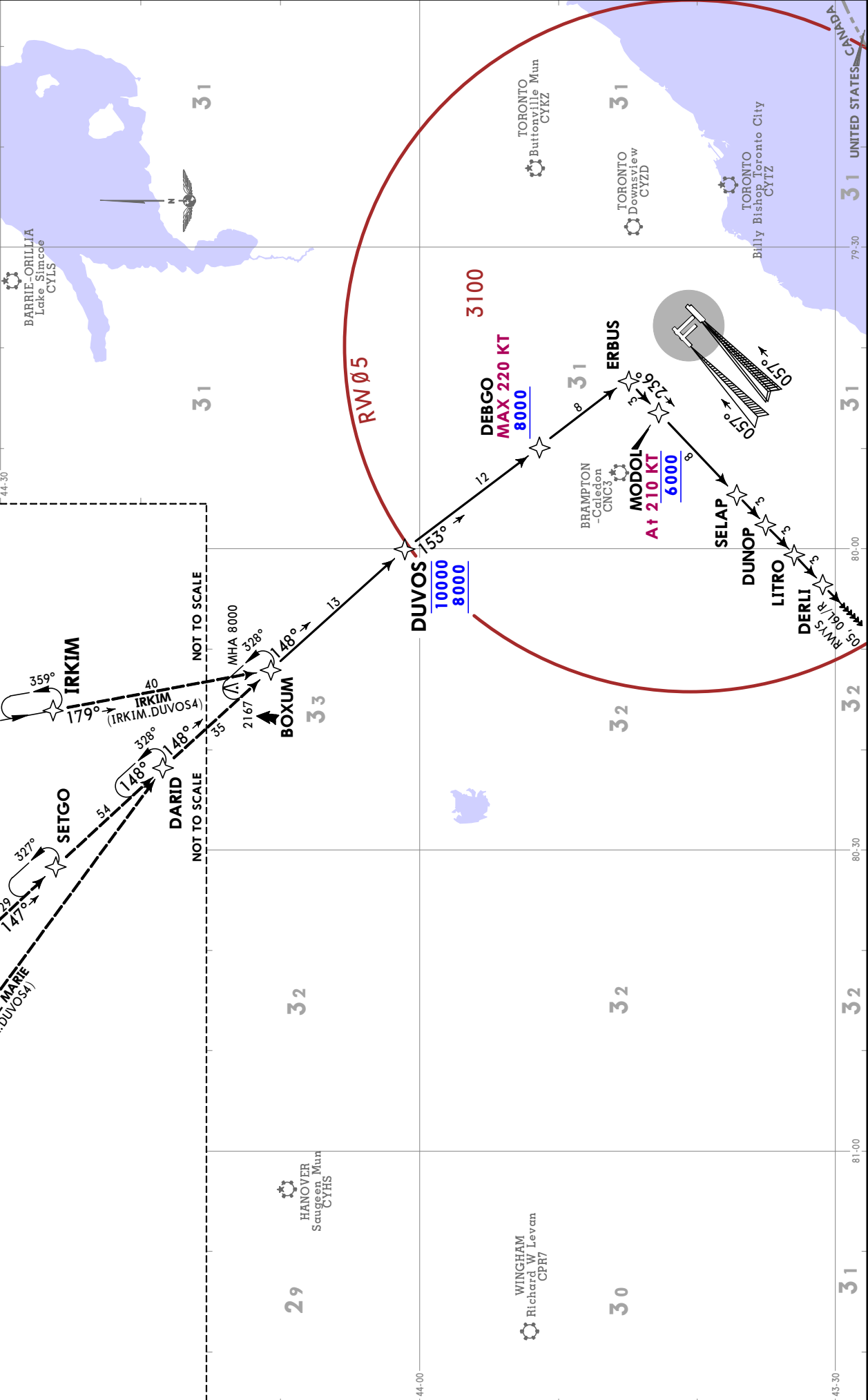

CYYZ/YYZ
 LESTER B PEARSON INTL

JEPPesen
28 APR 23 (10-2B)
TORONTO, ONT
RNAV STAR

CYYZ/YYZ
LESTER B PEARSON INTL

D-ATIS 120.825	133.1	Apt Elev 569	Alt Set: INCHES Trans level: FL180
DUVOS 4 ARRIVAL (BOXUM.DUVOS4) (RWYS 15L/R)		RNAV 1 - D/D/1 or GNSS required	
1. Safe Altitude within 100 NM 4900. 2. Non-Jet aircraft only. 3. For non GNSS equipped aircraft, YSB and YVW DMEs must be operational.			

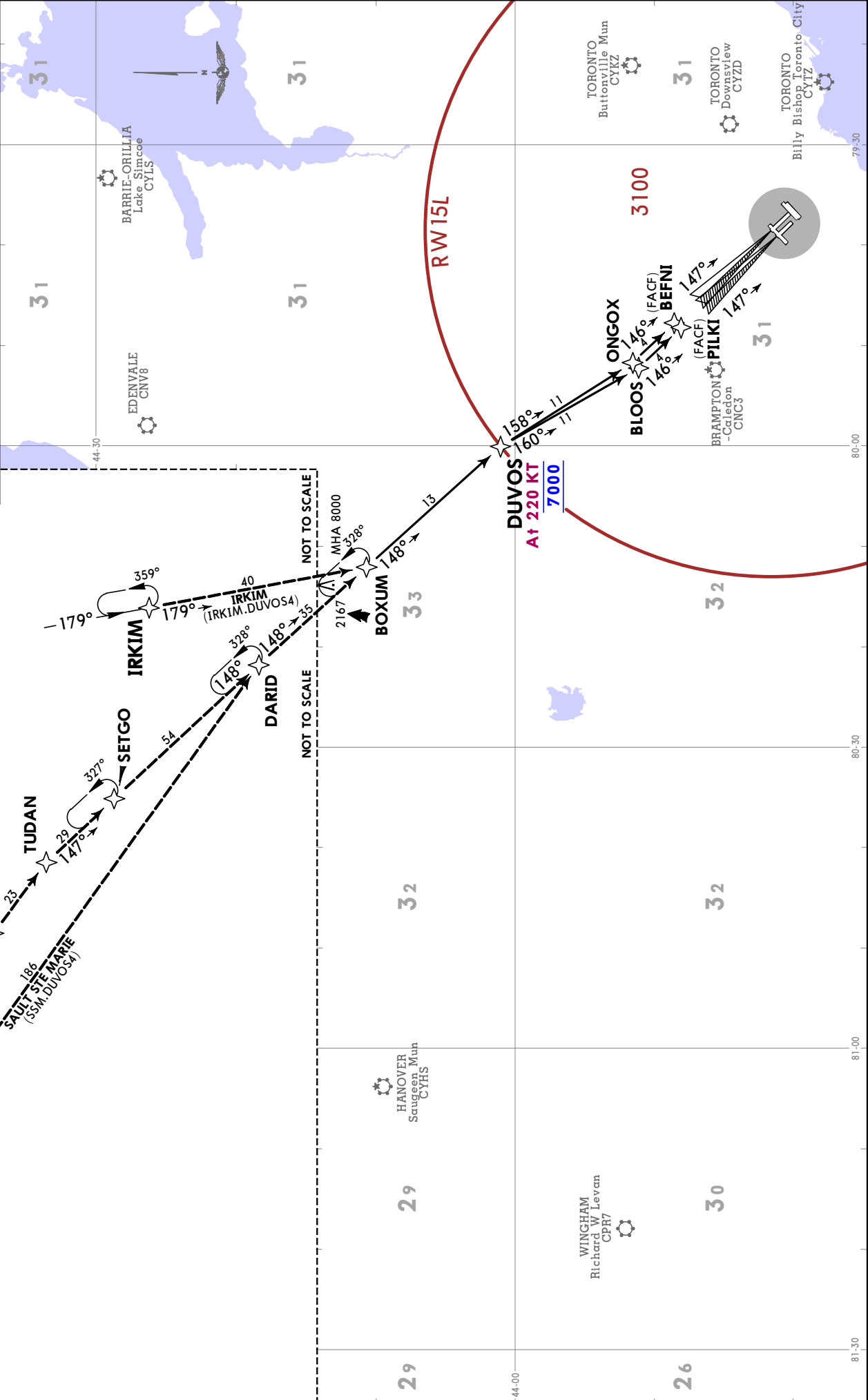

JEPPESEN TORONTO, ONT
RNAV STAR

28 APR 23 (10-2B2)
 D-ATIS 120.825 133.1 Apt Elev 569
 Alt Set: INCHES Trans level: FL180
 RNAV 1 - D/D/1 or GNSS required
 1. Safe Altitude within 100 NM 4900.
 2. Non-Jet aircraft only.
 3. For non GNSS equipped aircraft, YSB and YVV DMEs must be operational.

**DUVOS 4 ARRIVAL
 (BOXUM.DUVOS4)
 (RWYS 23, 24L/R)**

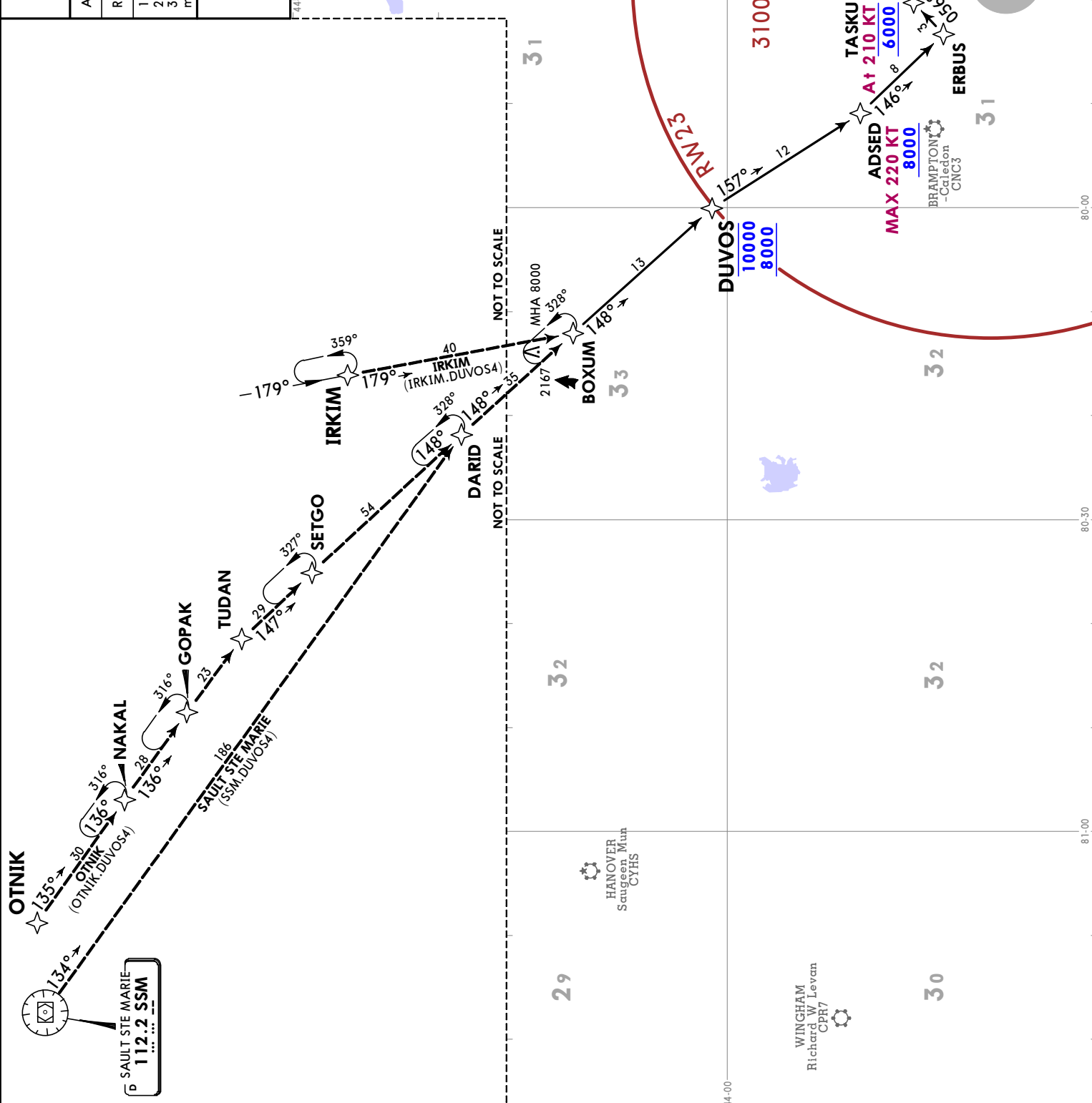
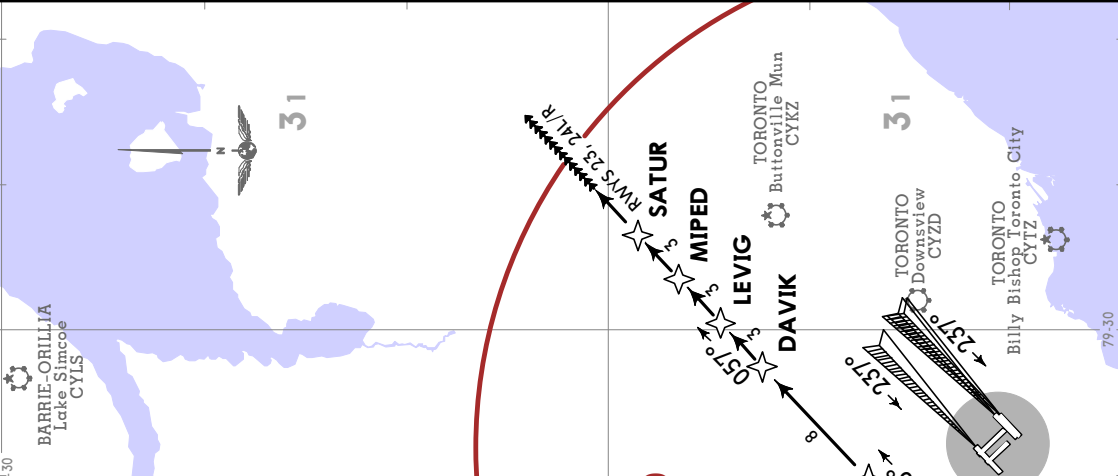

JEPPESEN
28 APR 25 (10-2B3)

CYYZ/YYZ
LESTER B PEARSON INTL

TORONTO, ONT
RNAV STAR

D-ATIS 120.825	Apt Elev 569	Alt Set: INCHES Trans level: FL180
133.1		RNAV 1 - D/D/I or GNSS required
		1. Safe Altitude within 100 NM 4900. 2. Non-Jet aircraft only. 3. For non GNSS equipped aircraft, YSB and YVY DMEs must be operational.

DUVOS 4 ARRIVAL (BOXUM.DUVOS4)
(RWY 33L)

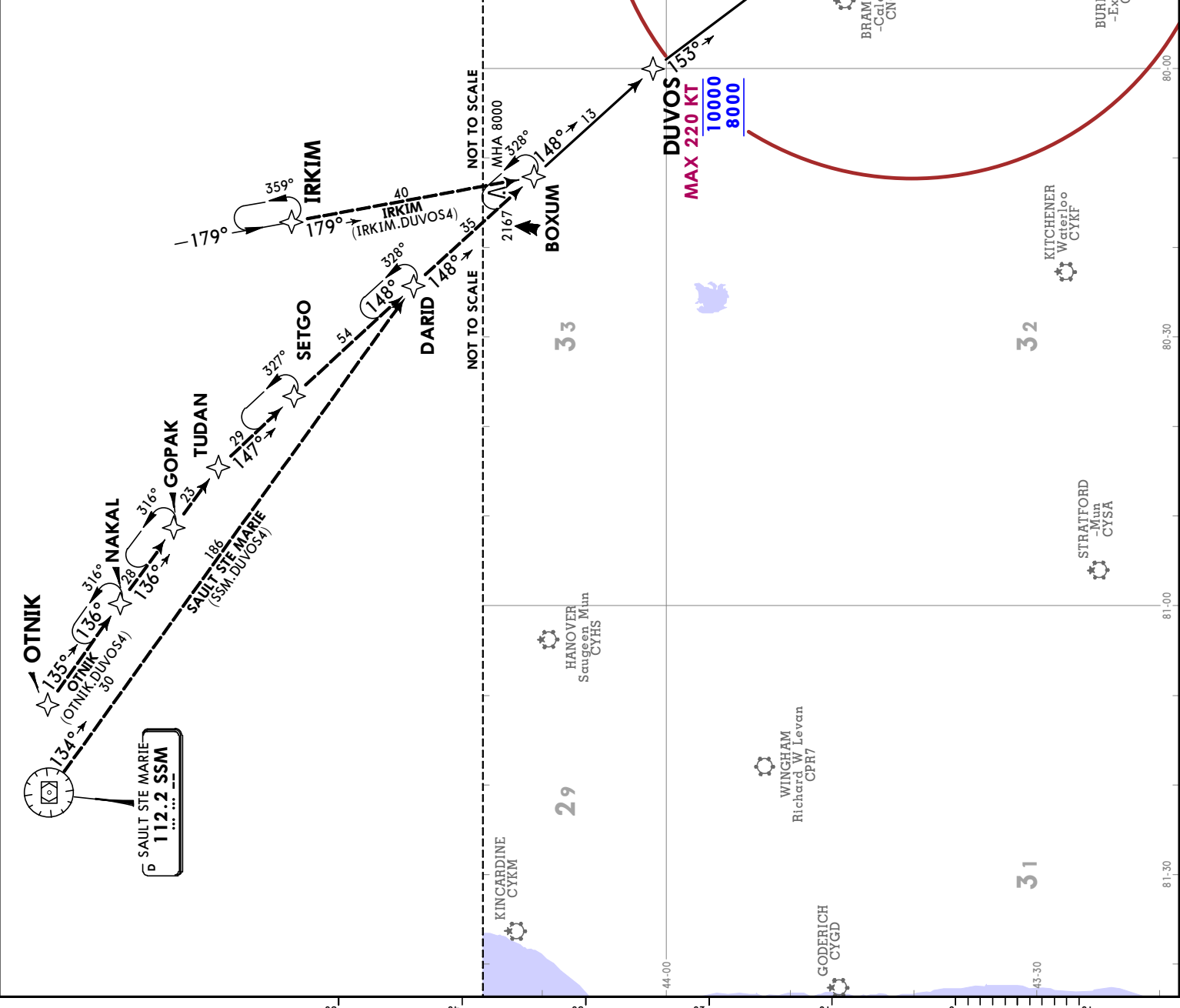

JEPPESEN
 28 APR 23 (10-2B4)
TORONTO, ONT
RNAV STAR

D-ATIS	120.825	133.1	Apt Elev	569
A/H Set: INCHES Trans level: FL180				
RNAV 1 - D/D/1 or GNSS required				
1. Safe Altitude within 100 NM 4900. 2. Non-Jet aircraft only. 3. For non GNSS equipped aircraft, YSB and YVV DMEs must be operational.				
DUVOS 4 ARRIVAL (BOXUM.DUVOS4) (RWY 33R)				

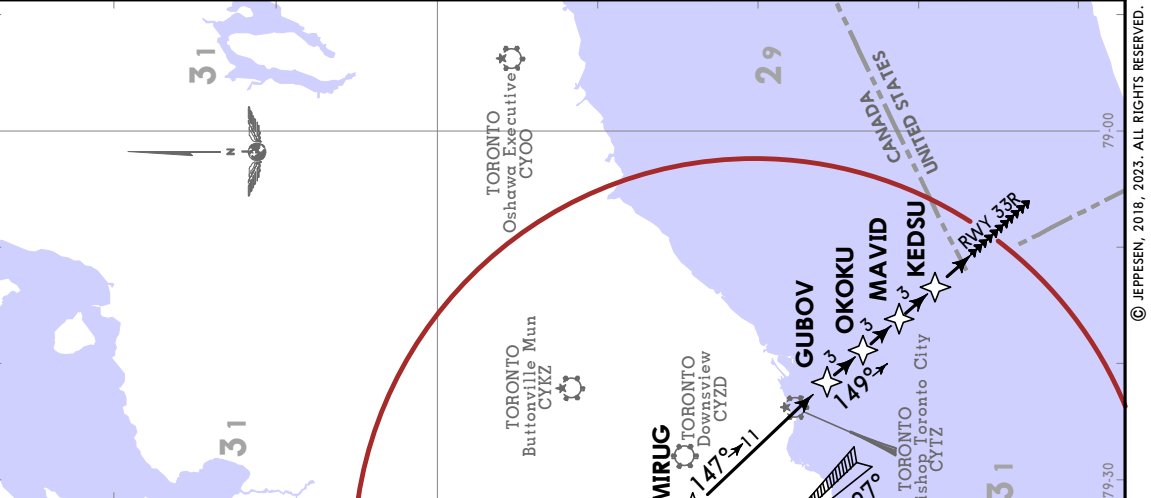

CYYZ/YYZ
 LESTER B PEARSON INTL

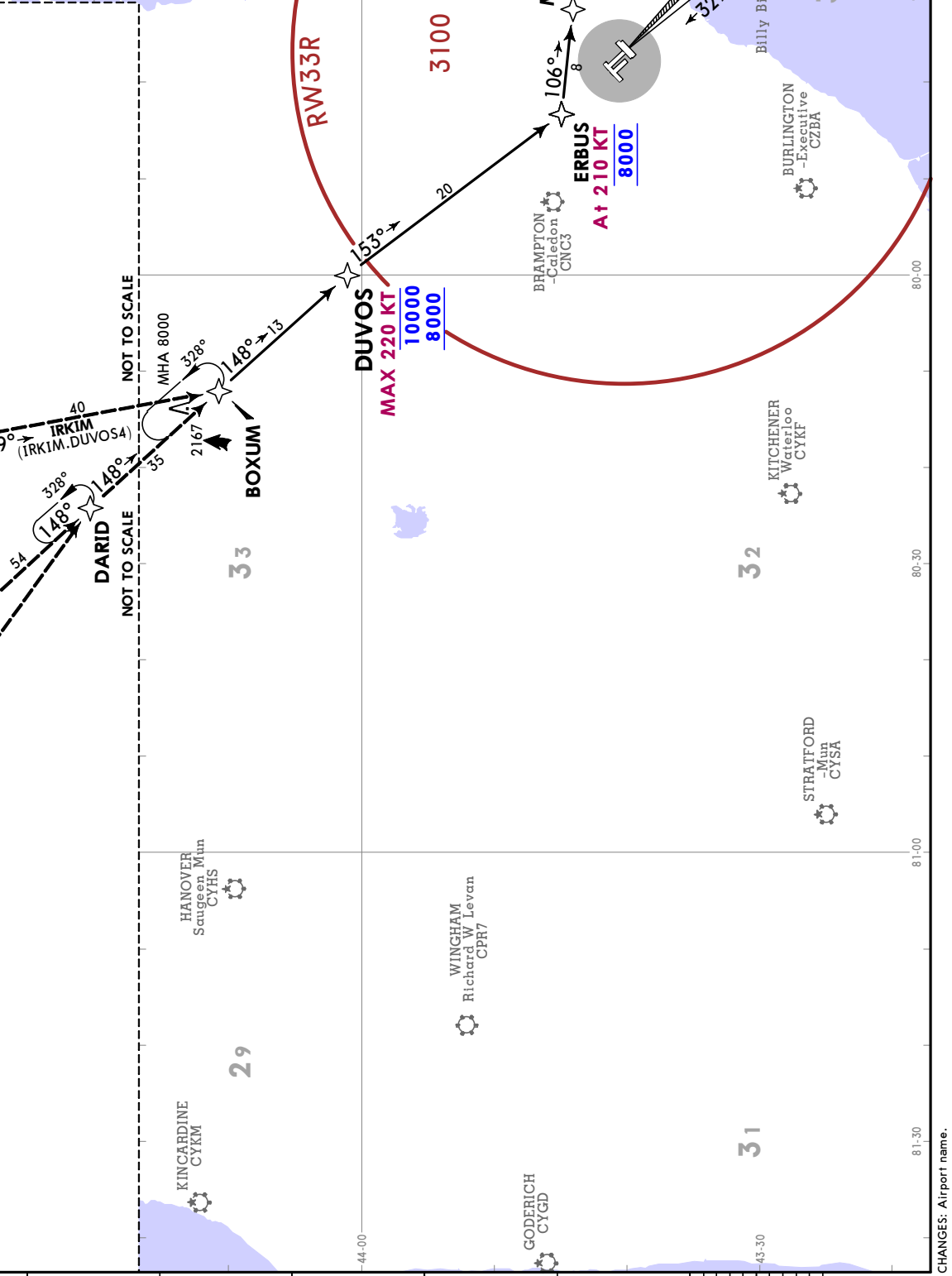
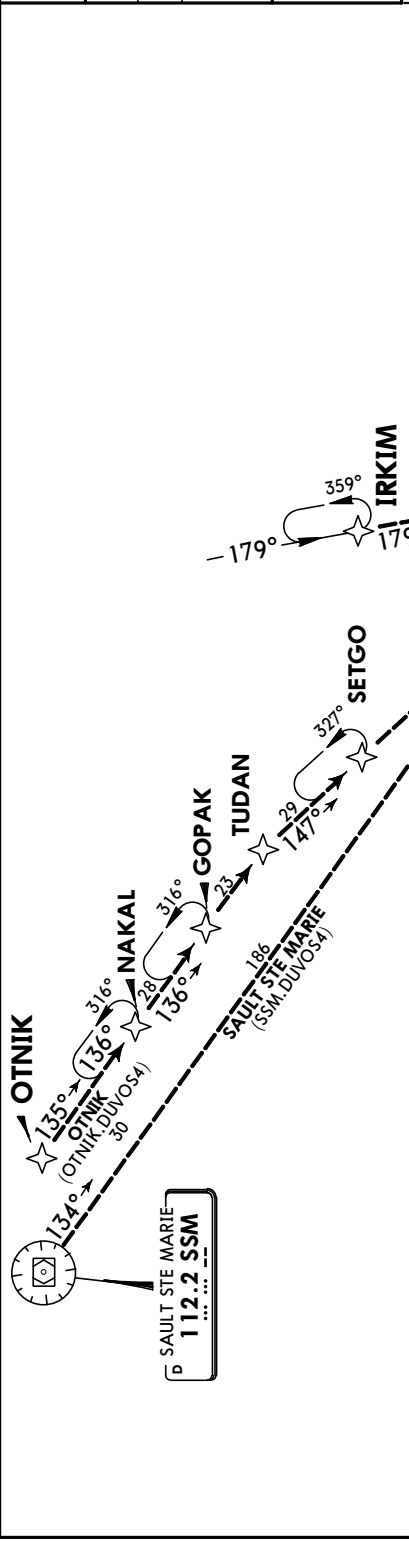

JEPPESEN TORONTO, ONT
RNAV STAR

28 APR 23 (10-2C)
 D-ATIS 120.825 133.1 Apt Elev 569
 Alt Set: INCHES Trans level: FL180
 RNAV 1 - D/D/1 or GNSS required
 1. Safe Altitude within 100 NM 4900.
 2. Jet aircraft only.
 3. For non GNSS equipped aircraft, YOW DME must be operational.

IMEBA 9 ARRIVAL
 (IMEBA.IMEBA9)
 (RWYS 05, 06L/R)

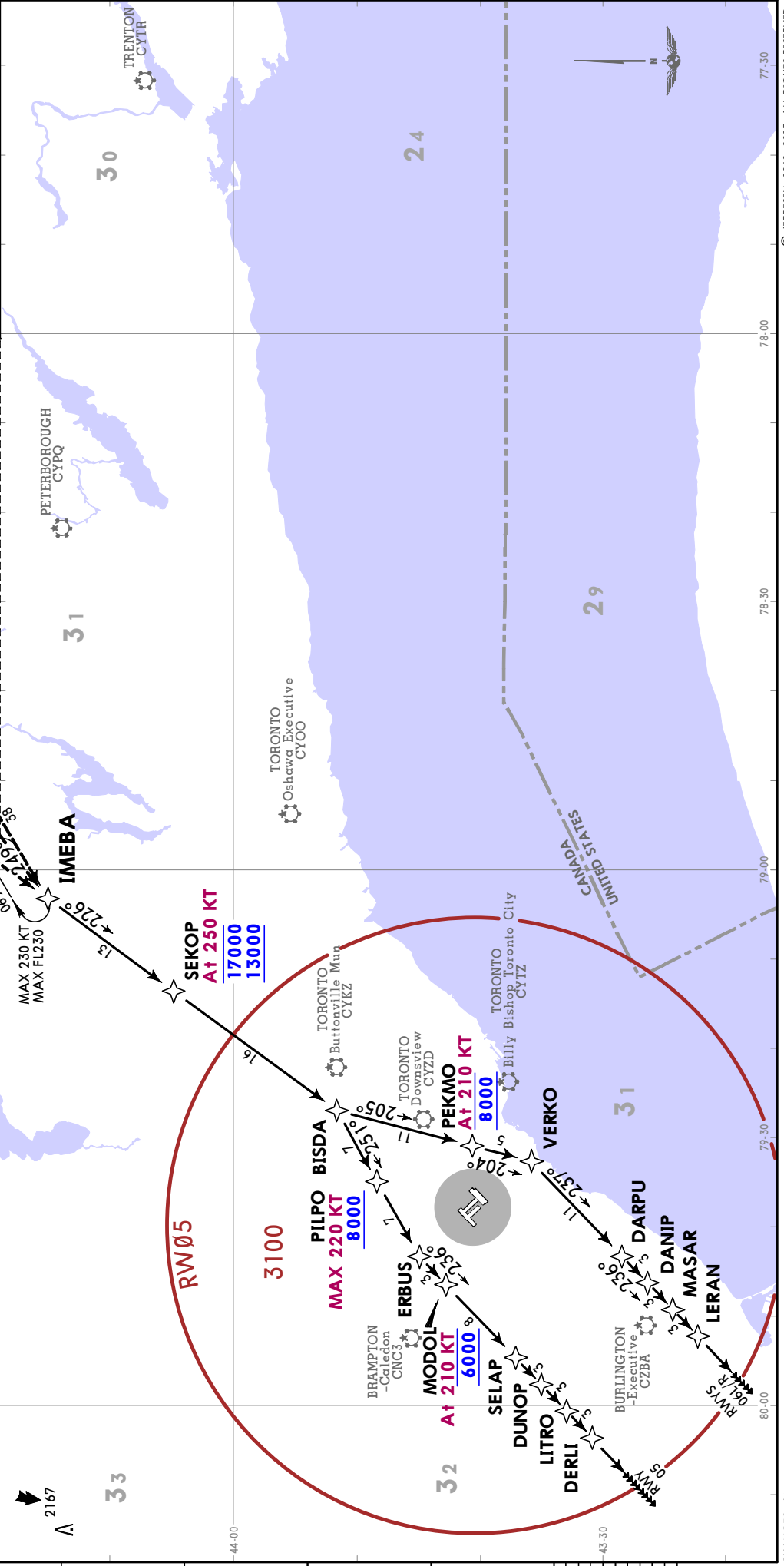
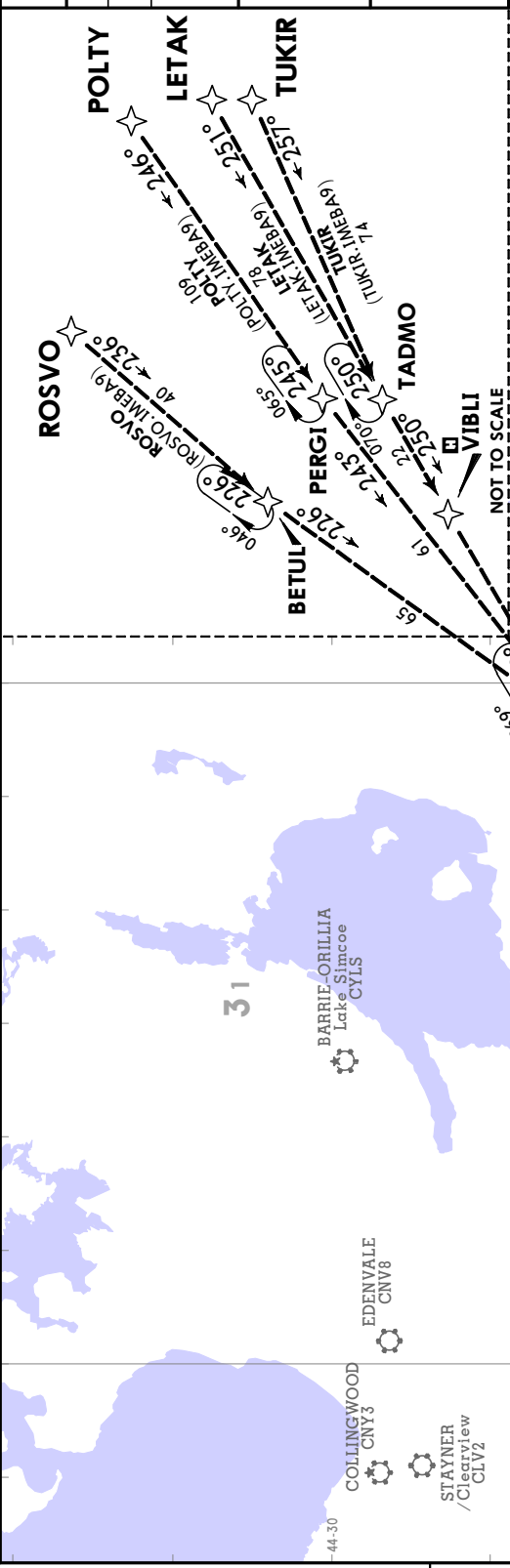

JEPPESSEN
28 APR 23 (10-2C)

CYYZ/YYZ
LESTER B PEARSON INTL

TORONTO, ONT
RNAV STAR

D-ATIS 120.825 133.1	Alt Set: INCHES Trans level: FL180
Apt Elev 569	RNAV 1 - D/D/1 or GNSS required
	1. Safe Altitude within 100 NM 4900. 2. Jet aircraft only. 3. For non GNSS equipped aircraft, YOW DME must be operational.

IMEBA 9 ARRIVAL
(IMEBA.IMEBA9)
(RWYS 15L/R)

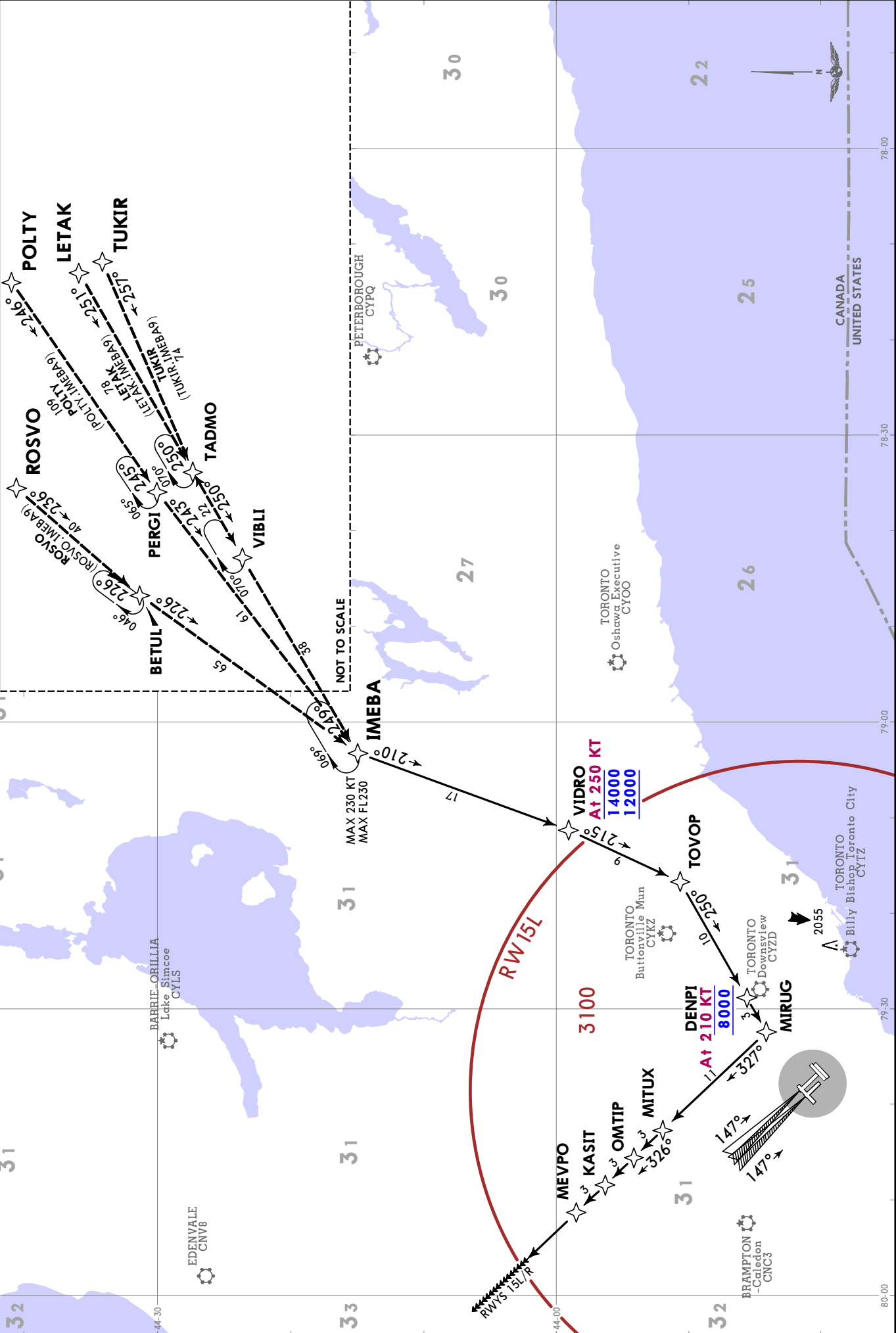

JEPPESEN
28 APR 23 (10-2C3)
TORONTO, ONT
RNAV STAR

CYYZ/YYZ
LESTER B PEARSON INTL

Alt Set: INCHES Trans level: FL180
RNAV 1 - D/D/I or GNSS required
1. Safe Altitude within 100 NM 4900.
2. Jet aircraft only.
3. For non GNSS equipped aircraft, YOW DME must be operational.
IMEBA 9 ARRIVAL (IMEBA.IMEBA9)
(RWYS 33L/R)

D-ATIS 120.825 133.1
Apt Elev 569

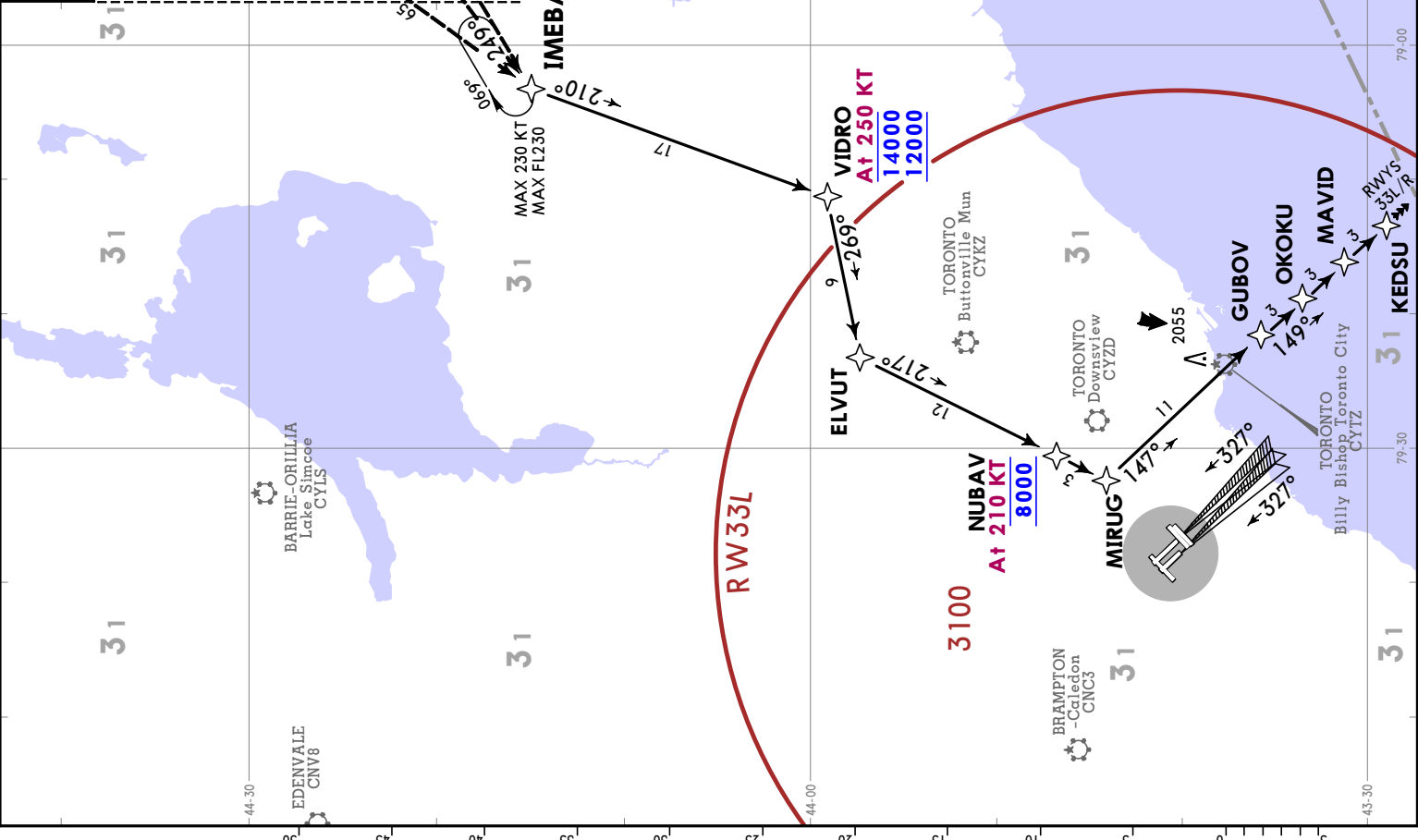

CHANGES: Airport name.

CYYZ/YYZ
LESTER B PEARSON INTL

D-ATIS 120.825 133.1	Apt Elev 569	Alt Set: INCHES Trans level: FL180
		RNAV 1 - D/D/I or GNSS required
1. Safe Altitude within 100 NM 4900. 2. Jet aircraft only.		

**LINNG 3 ARRIVAL (LINNG.LINNG3)
(RWYS 05, 06L/R)**

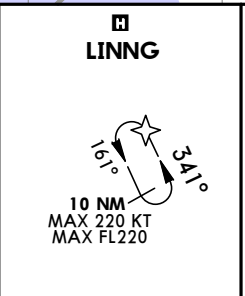
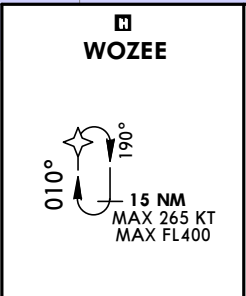
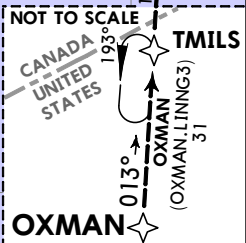
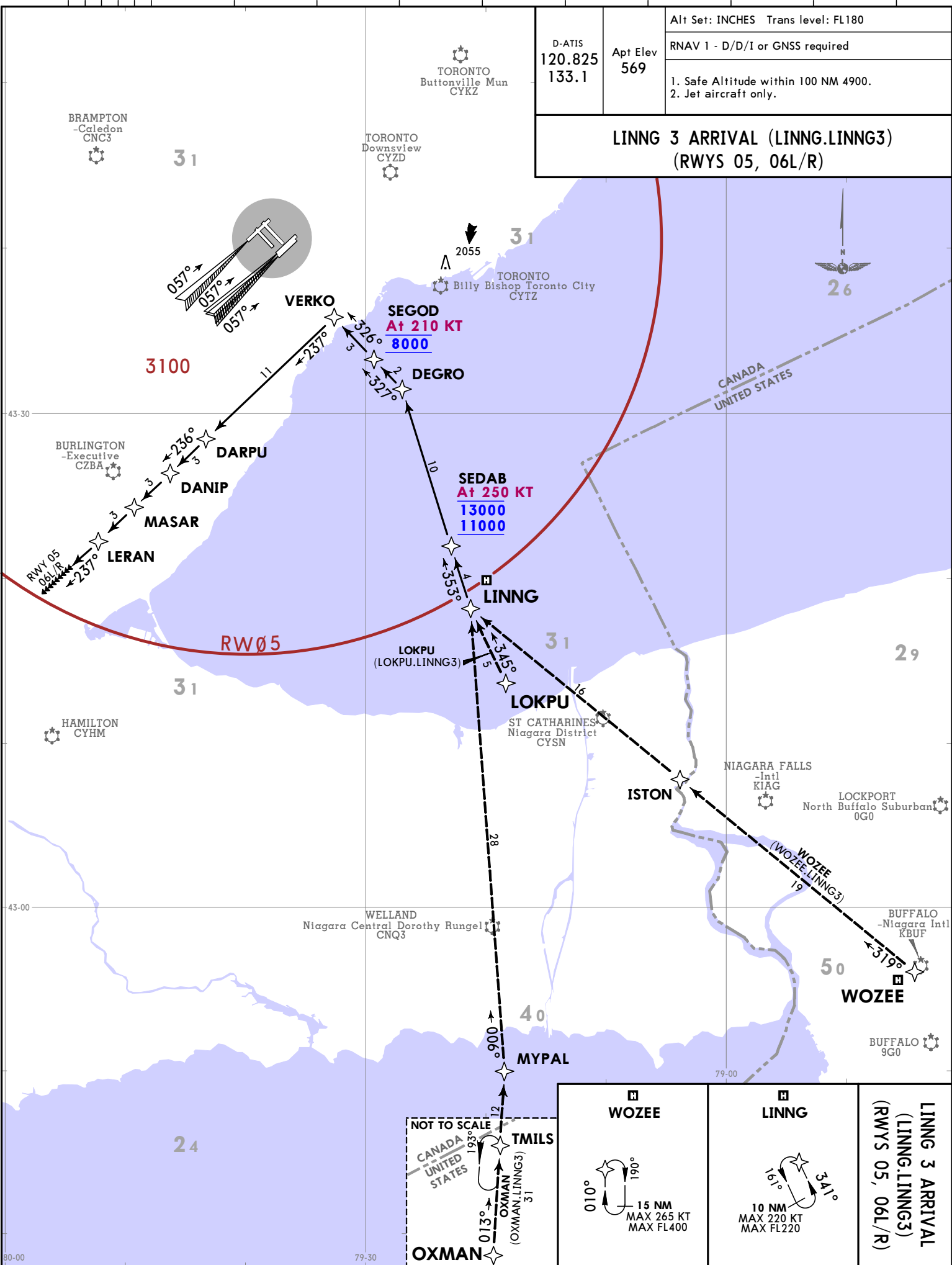

**LINNG 3 ARRIVAL
(LINNG.LINNG3)
(RWYS 05, 06L/R)**

28 APR 23 10-2D
JEPPESSEN TORONTO, ONT
RNAV STAR

© JEPPESSEN, 2018, 2023. ALL RIGHTS RESERVED.

CHANGES: Airport name.

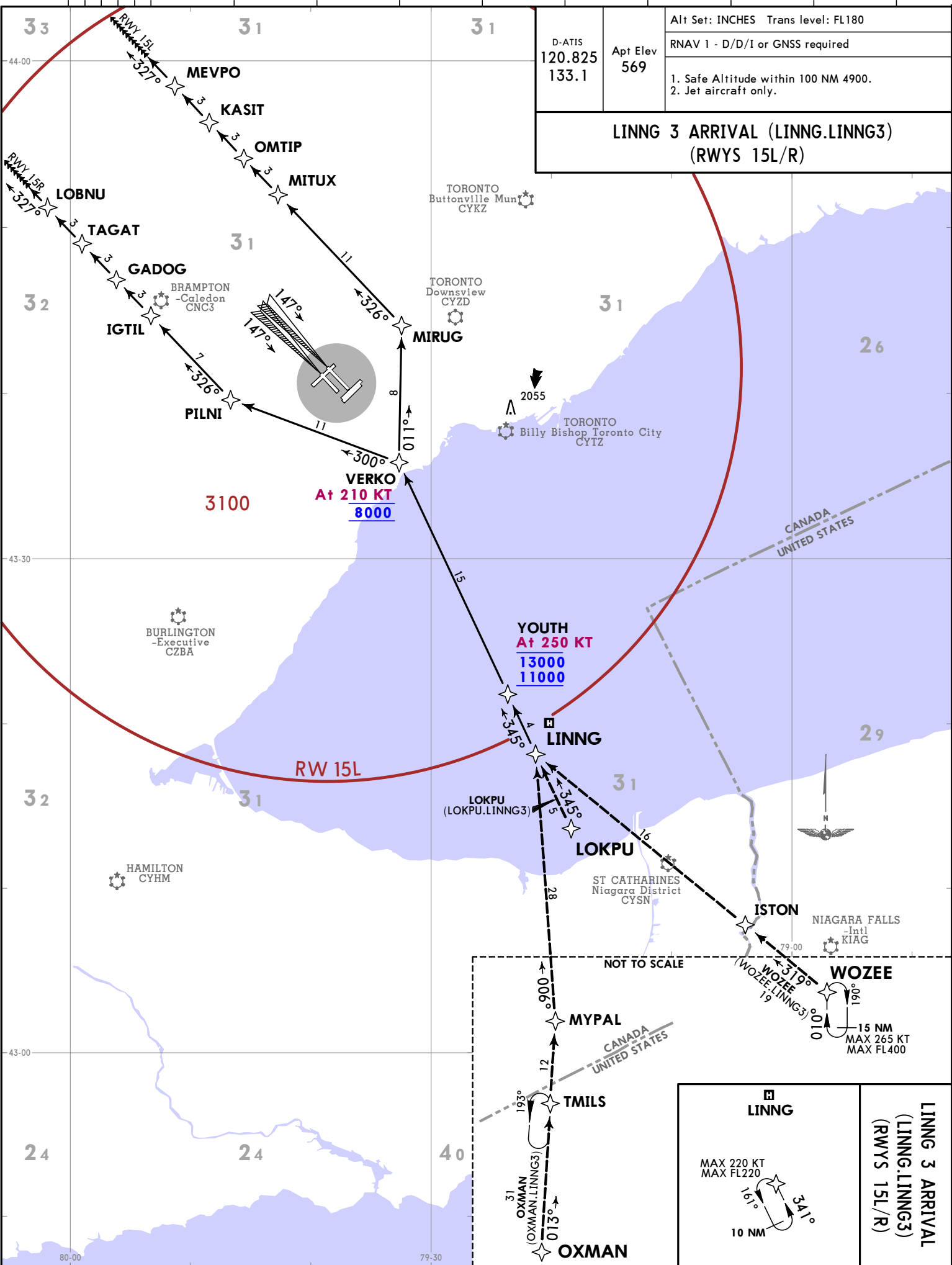

D-ATIS 120.825 133.1	Apt Elev 569	Alt Set: INCHES Trans level: FL180
RNAV 1 - D/D/I or GNSS required		
1. Safe Altitude within 100 NM 4900. 2. Jet aircraft only.		

LINNG 3 ARRIVAL (LINNG.LINNG3) (RWYS 15L/R)

CYYZ/YYZ
LESTER B PEARSON INTL

28 APR 23 (0-2D1)

JEPPESEN
TORONTO, ONT
RNAV STAR

© JEPPESEN, 2018, 2023. ALL RIGHTS RESERVED.

CHANGES: Airport name.

CYYZ/YYZ
LESTER B PEARSON INTL

D-ATIS 120.825 133.1	Apt Elev 569	Alt Set: INCHES Trans level: FL180
		RNAV 1 - D/D/I or GNSS required
		1. Safe Altitude within 100 NM 4900. 2. Jet aircraft only.

LINNG 3 ARRIVAL (LINNG.LINNG3)
(RWYS 23, 24L/R)

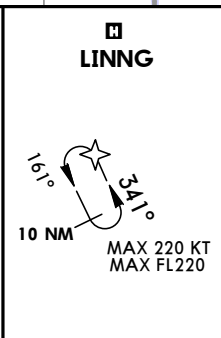
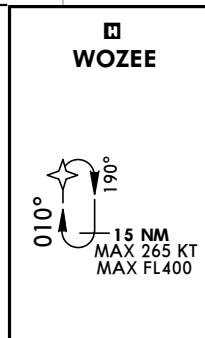
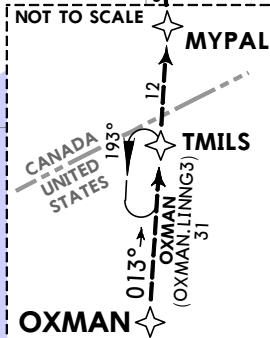
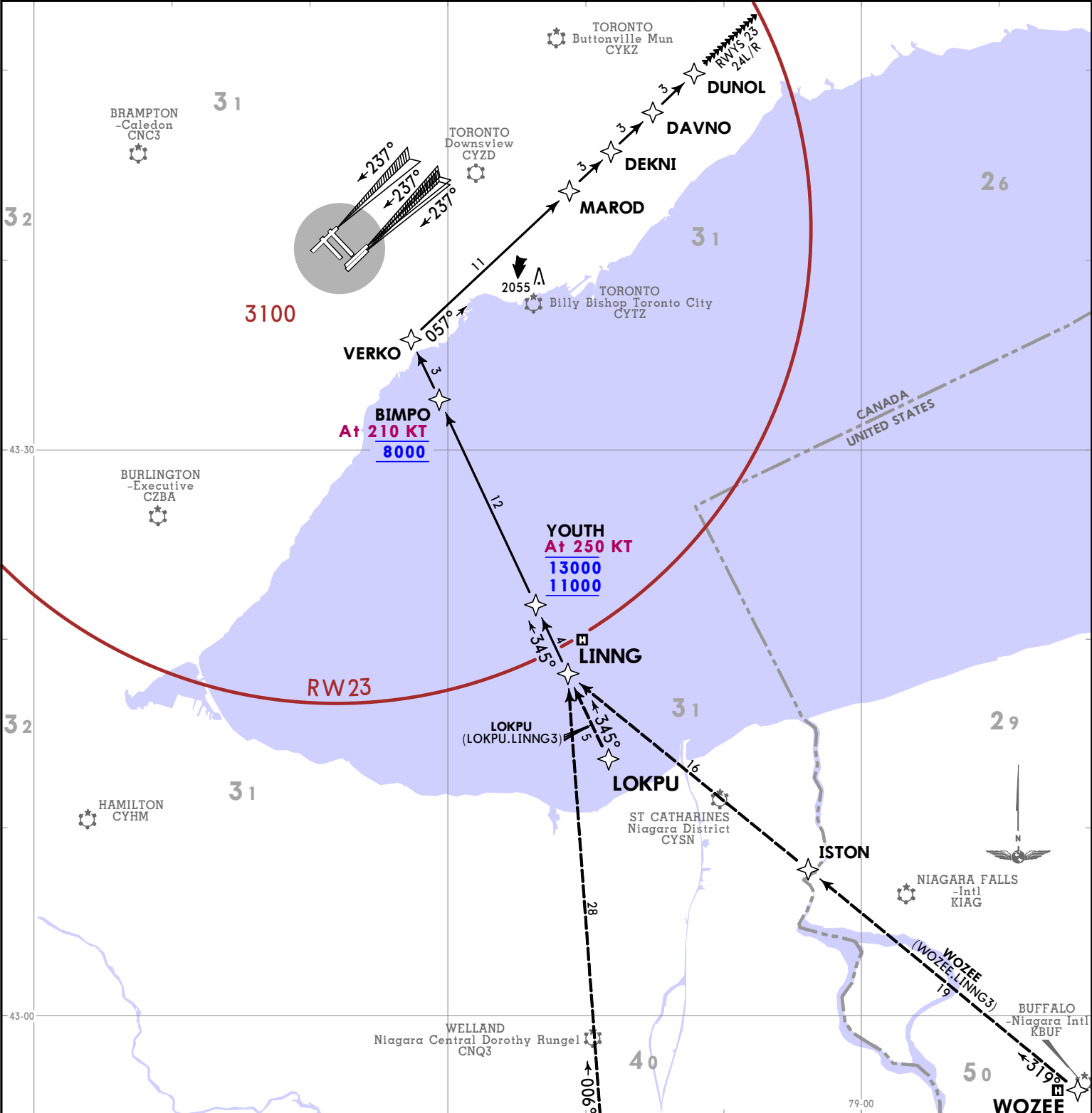

LINNG 3 ARRIVAL
(LINNG.LINNG3)
(RWYS 23, 24L/R)

28 APR 23 (10-2D2)

JEPPESSEN TORONTO, ONT
RNAV STAR

© JEPPESSEN, 2018, 2023. ALL RIGHTS RESERVED.

CHANGES: Airport name.

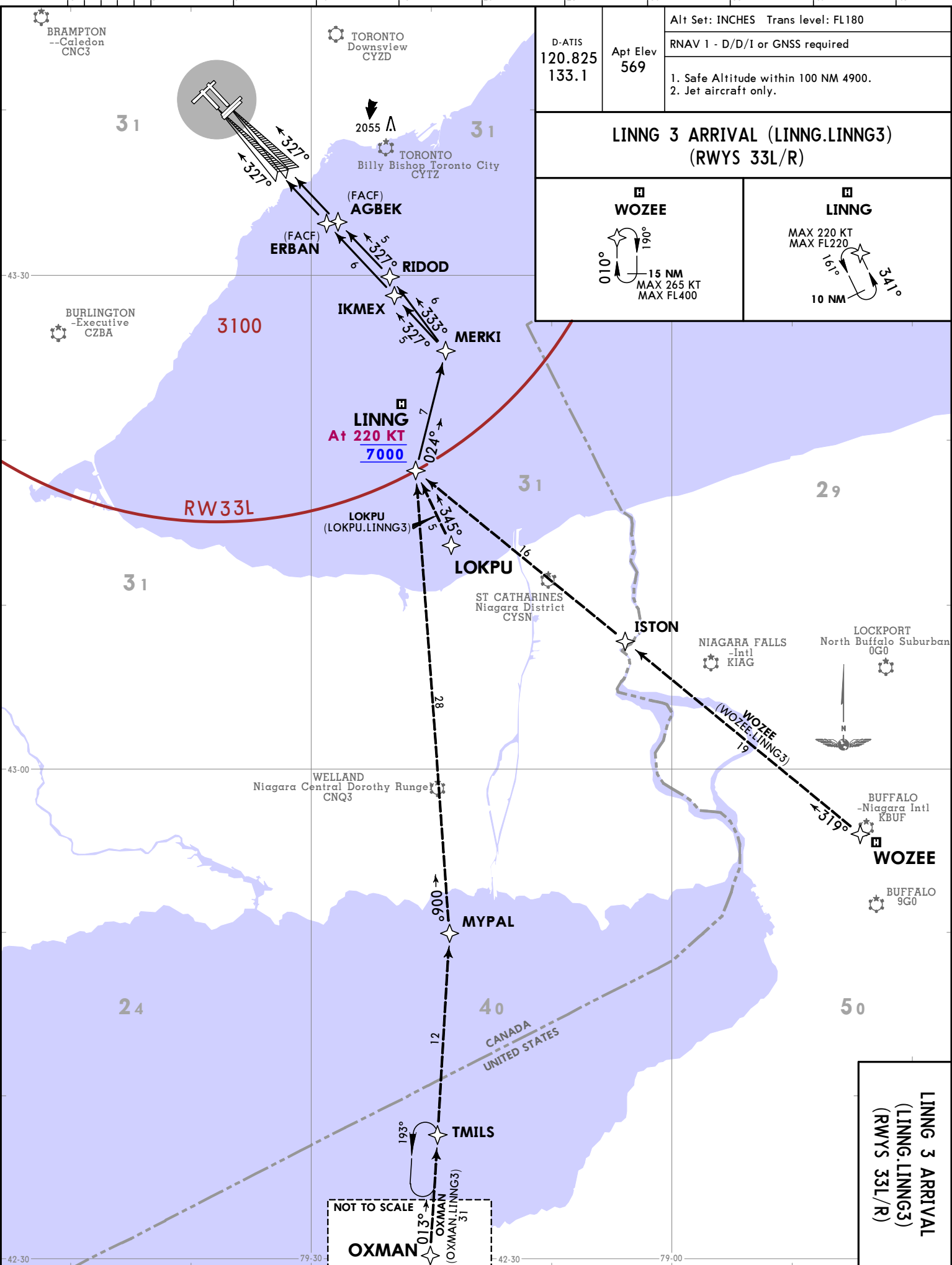

D-ATIS 120.825 133.1	Apt Elev 569	Alt Set: INCHES Trans level: FL180
RNAV 1 - D/D/I or GNSS required		
1. Safe Altitude within 100 NM 4900. 2. Jet aircraft only.		

**LINNG 3 ARRIVAL (LINNG.LINNG3)
(RWYS 33L/R)**

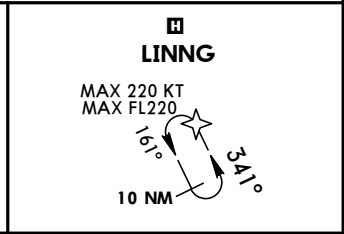
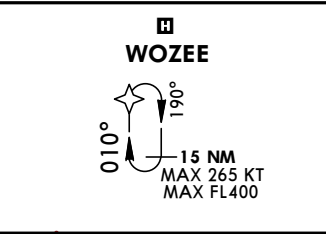

CYYZ/YYZ
LESTER B PEARSON INTL

JEPPESSEN
28 APR 23 (10-2D3)

TORONTO, ONT
RNAV STAR

**LINNG 3 ARRIVAL
(LINNG.LINNG3)
(RWYS 33L/R)**

NOT TO SCALE
OXMAN (OXMAN.LINNG3)
TMILS (TMILS.LINNG3)

© JEPPESSEN, 2018, 2023. ALL RIGHTS RESERVED.

JEPPesen
TORONTO, ONT
RNAV STAR

28 APR 23 10-2E

NAKBO 5 ARRIVAL (NUBER.NAKBO5)
(RWYS 05, 06L/R)

Alt Set: INCHES Trans level: FL180
RNAV 1 - D/D/I or GNSS required
1. Safe Altitude within 100 NM 4900.
2. Non-Jet aircraft only.

Apt Elev
569

D-ATIS
120.825 133.1

CYYZ/YYZ
LESTER B. PEARSON INTL

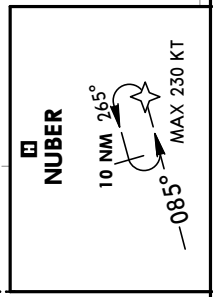
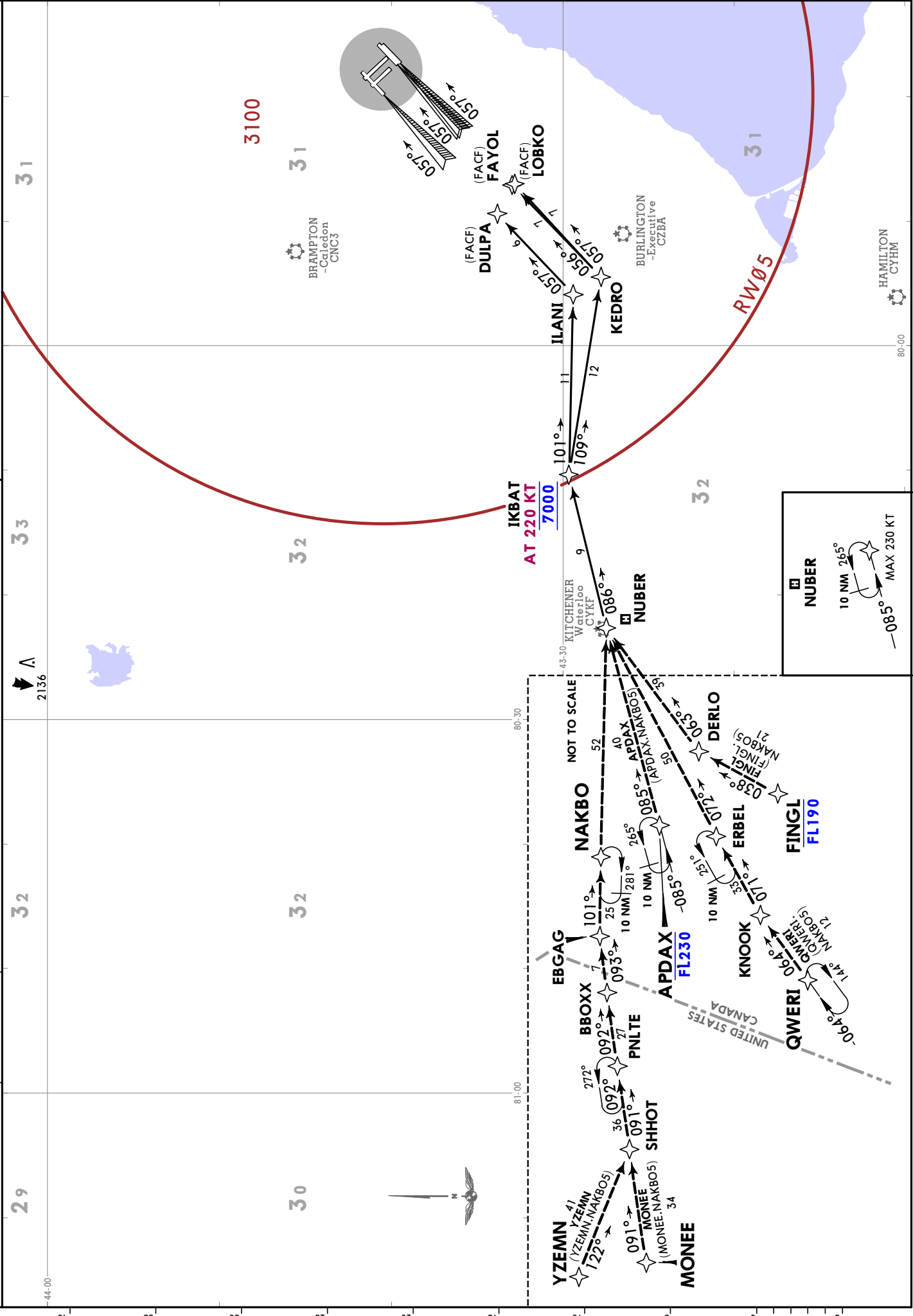

TORONTO, ONT
RNAV STAR

D-ATIS	120.825	133.1	Apt Elev	569
Alt Set: INCHES Trans level: FL180				
RNAV 1 - D/D/1 or GNSS required				
1. Safe Altitude within 100 NM 4900. 2. Non-Jet aircraft only.				

NAKBO 5 ARRIVAL
 (NUBER.NAKBO5)
 (RWYS 15L/R, 33L/R)

CYYZ/YYZ
 LESTER B PEARSON INTL

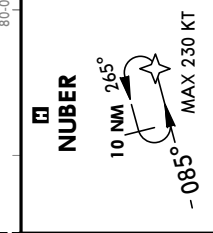
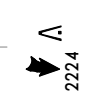
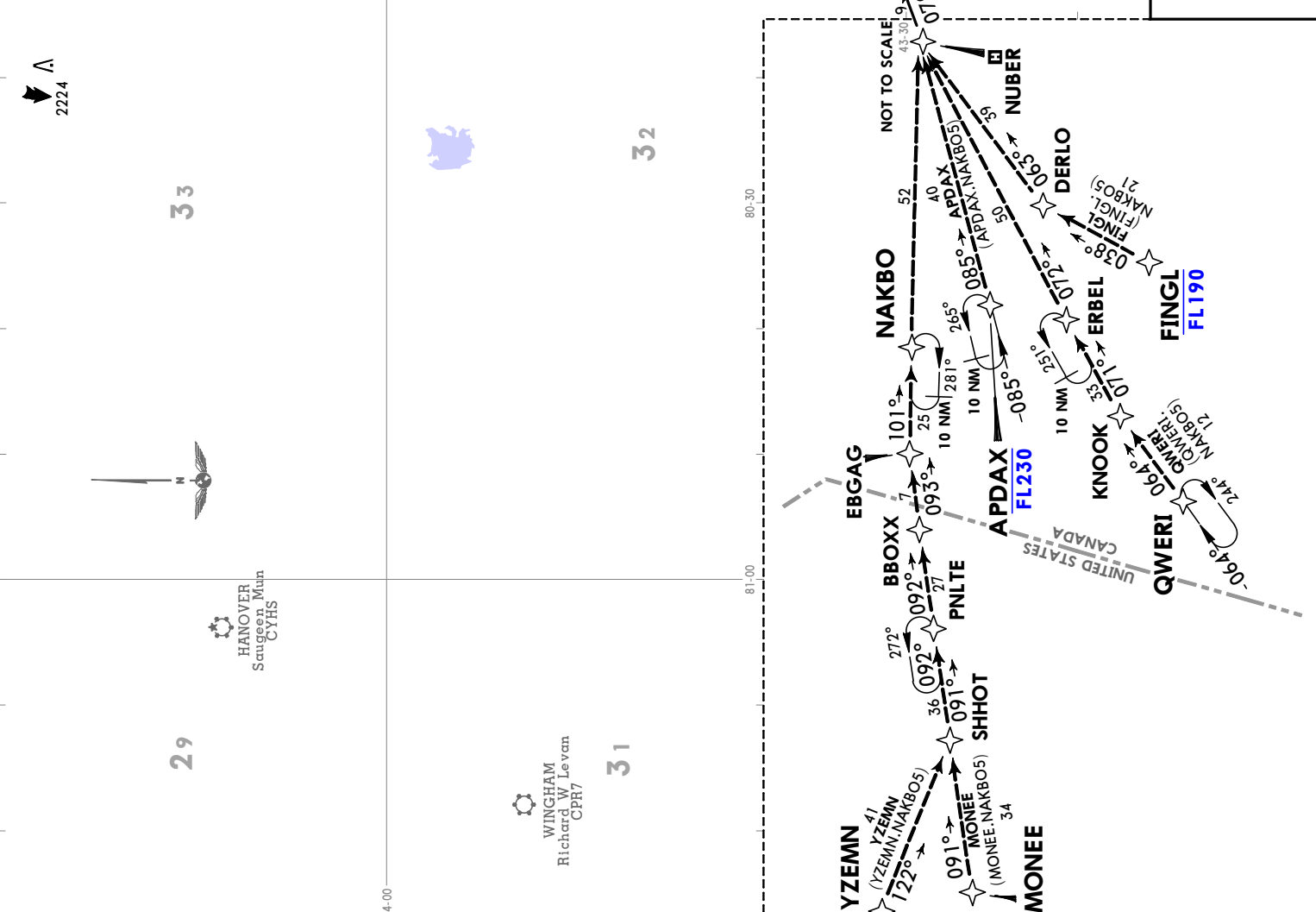

TORONTO, ONT
RNAV STAR

JEPPesen
 28 APR 23 (10-2E5)

CYYZ/YYZ
 LESTER B PEARSON INTL

D-ATIS	120.825	133.1	Apt Elev 569
Alt Set: INCHES	Trans level: FL180		
RNAV 1 - D/D/1 or GNSS required			
1. Safe Altitude within 100 NM 4900. 2. Jet aircraft only.			
NUBER 5 ARRIVAL (NUBER.NUMBERS) (RWYS 23, 24L/R)			

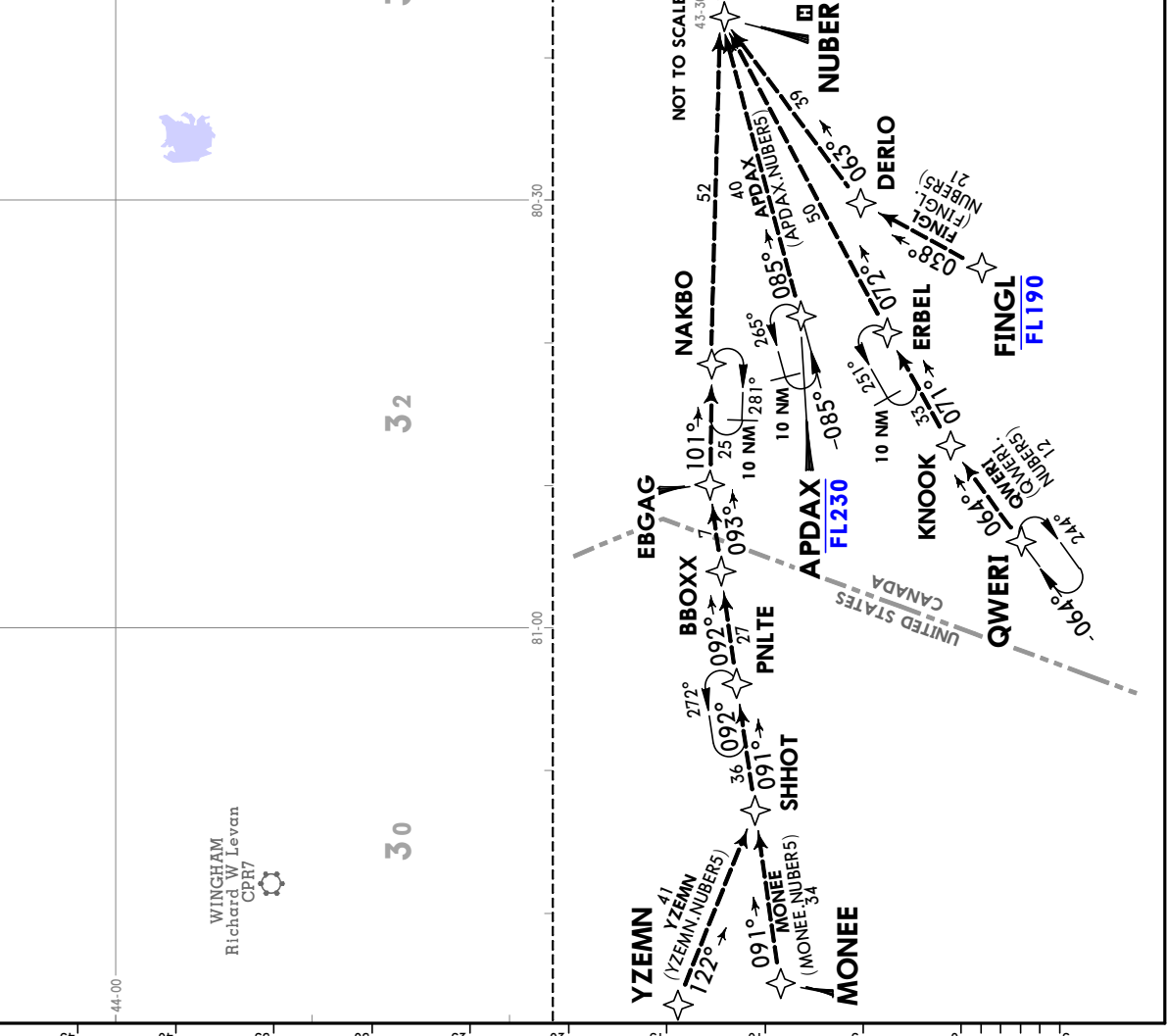
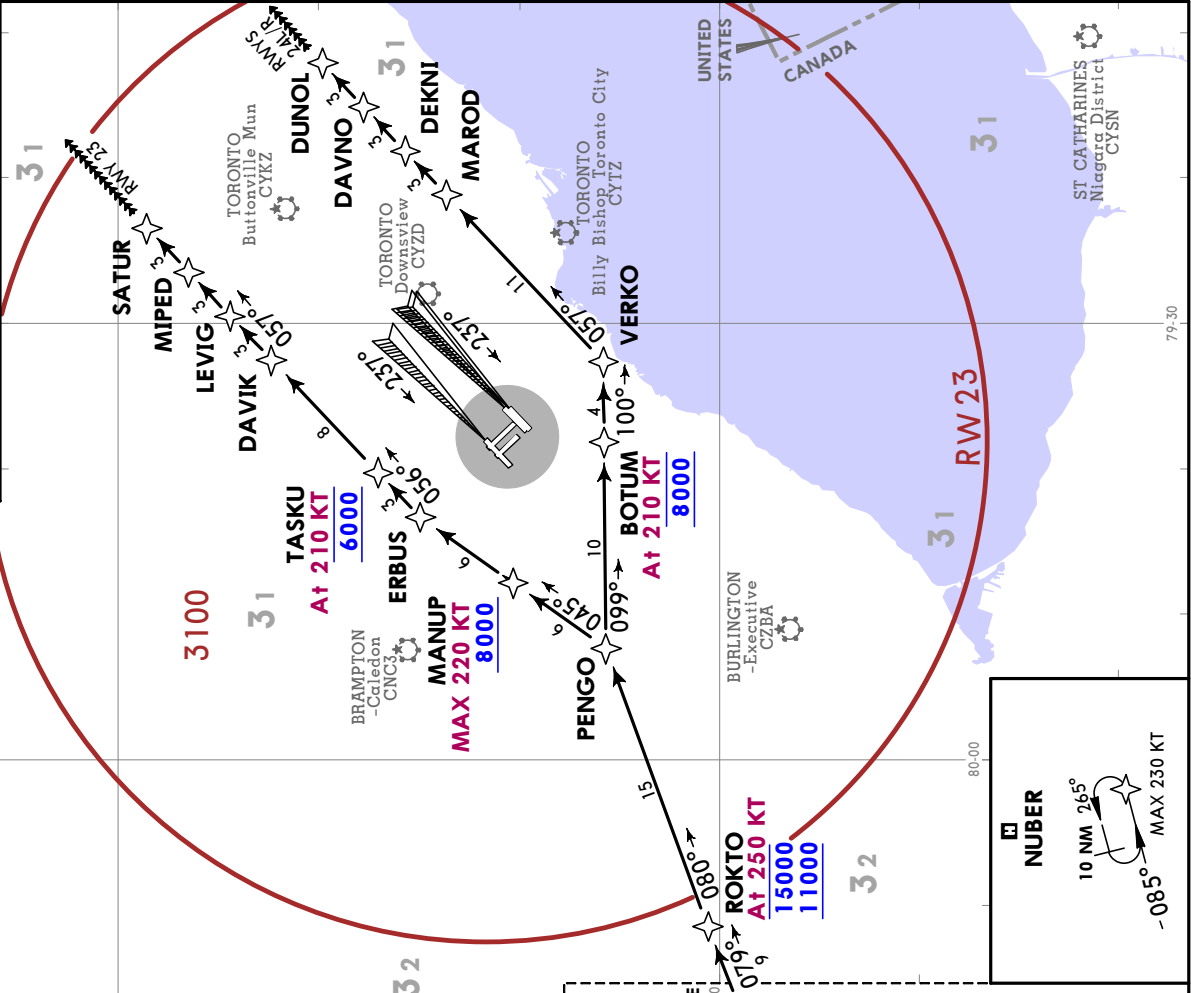
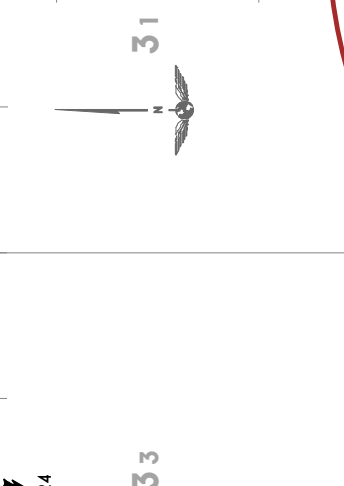

28 APR 23 (10-2F)

D-ATIS 120.825 133.1	Apt Elev 569	Alt Set: INCHES Trans level: FL180
RNAV 1 - D/D/1 or GNS5 required		
1. Safe Altitude within 100 NM 4900. 2. Jet aircraft only. 3. TUKIR transition: For non GNS5 equipped aircraft, YXI DME must be operational.		

RAGID 5 ARRIVAL (RAGID.RAGID5)
(RWYS 05, 06L/R)

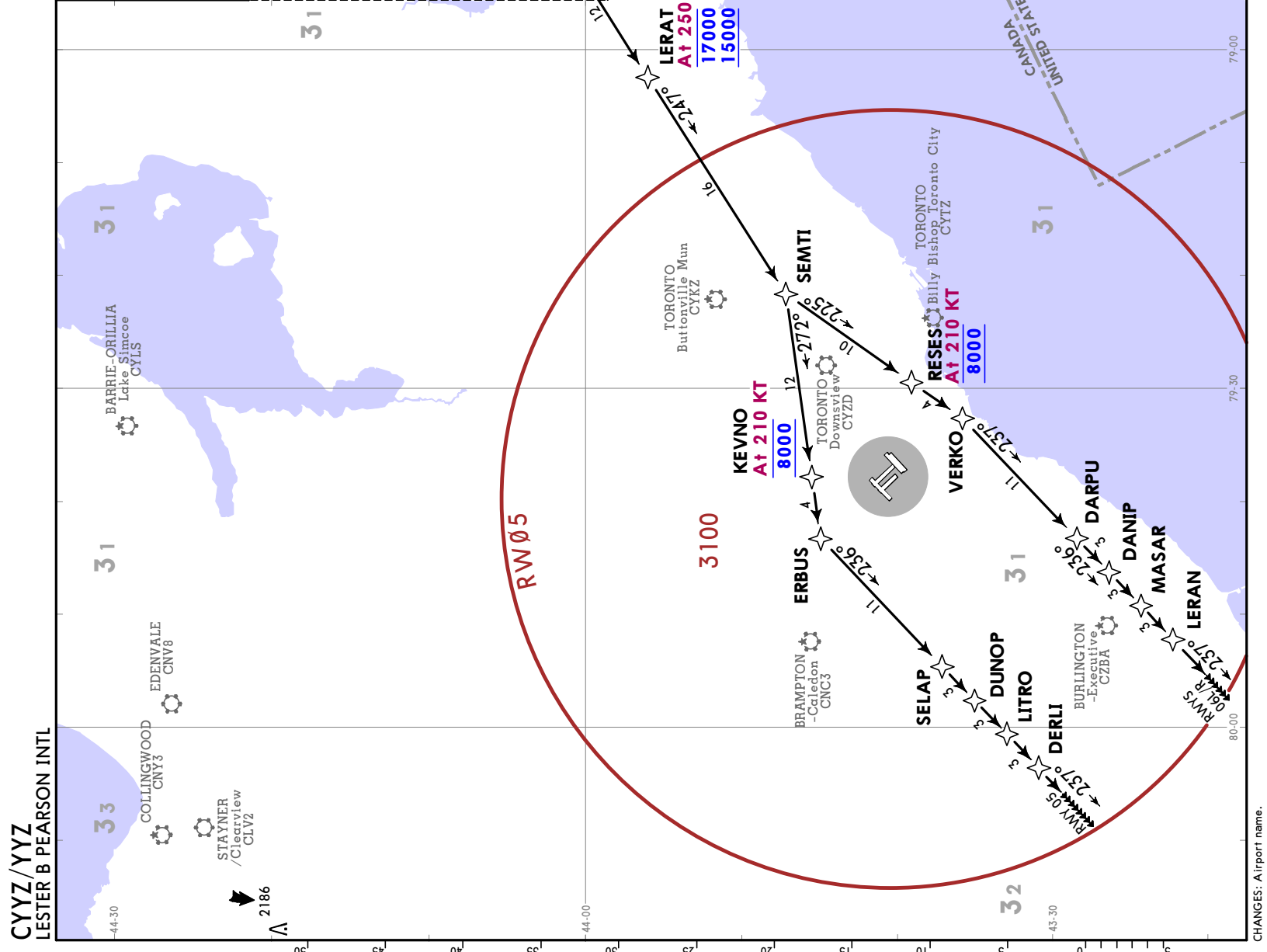
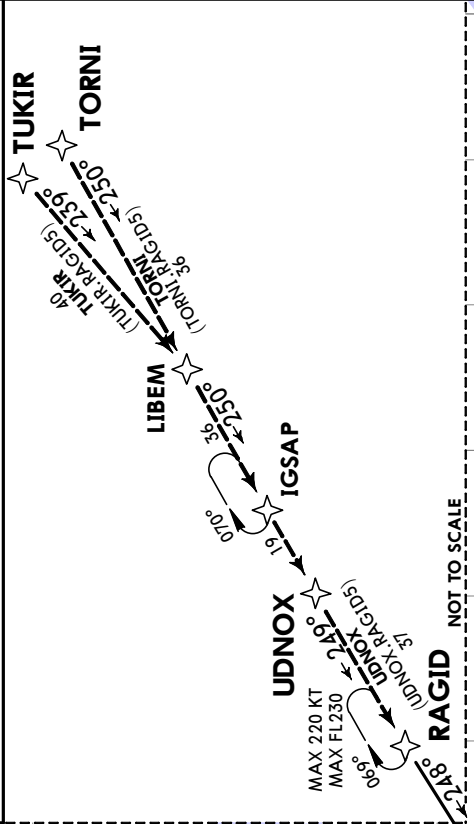

JEPPESEN
 28 APR 23 (10-2F)
CYYZ/YYZ
 LESTER B PEARSON INTL

TORONTO, ONT
RNAV STAR

D-ATIS 120.825 133.1	Apt Elev 569	Alt Set: INCHES Trans level: FL180
RNAV 1 - D/D/1 or GNSS required		
1. Safe Altitude within 100 NM 4900. 2. Jet aircraft only. 3. TUKIR transition: For non GNSS equipped aircraft, YXI DME must be operational.		
RAGID 5 ARRIVAL (RAGID.RAGID5) (RWYS 15L/R)		

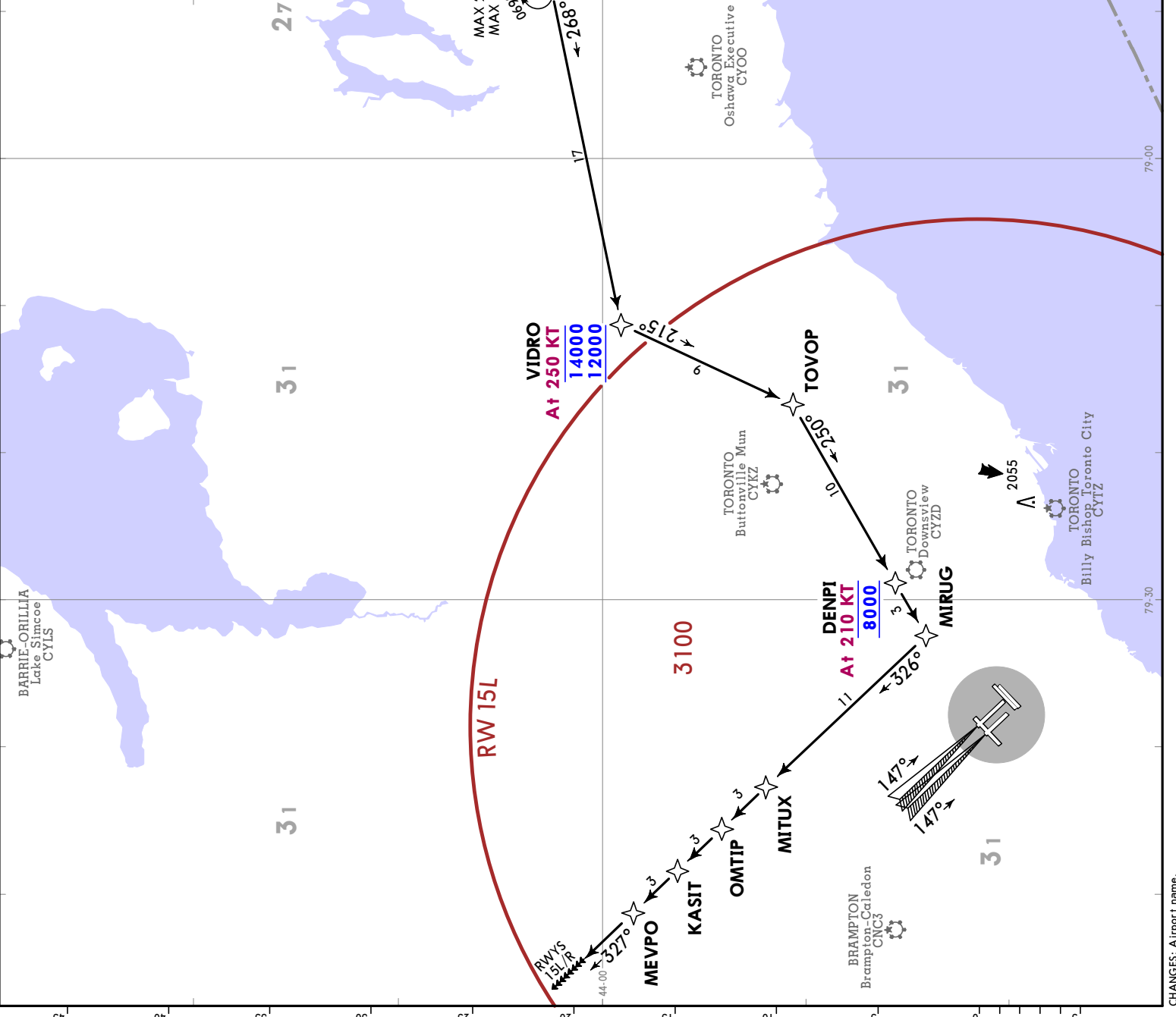

CYYZ/YYZ
LESTER B. PEARSON INTL

28 APR 23 (10-2F2)
RNAV STAR

JEPPESEN TORONTO, ONT
RNAV STAR

D-ATIS 120.825 133.1	Apt Elev 569	Alt Set: INCHES Trans level: FL180
RNAV 1 - D/D/1 or GNSS required		
1. Safe Altitude within 100 NM 4900. 2. Jet aircraft only. 3. TUKIR transition: For non GNSS equipped aircraft, YXI DME must be operational.		

RAGID 5 ARRIVAL (RAGID.RAGID5)
(RWYS 23, 24L/R)

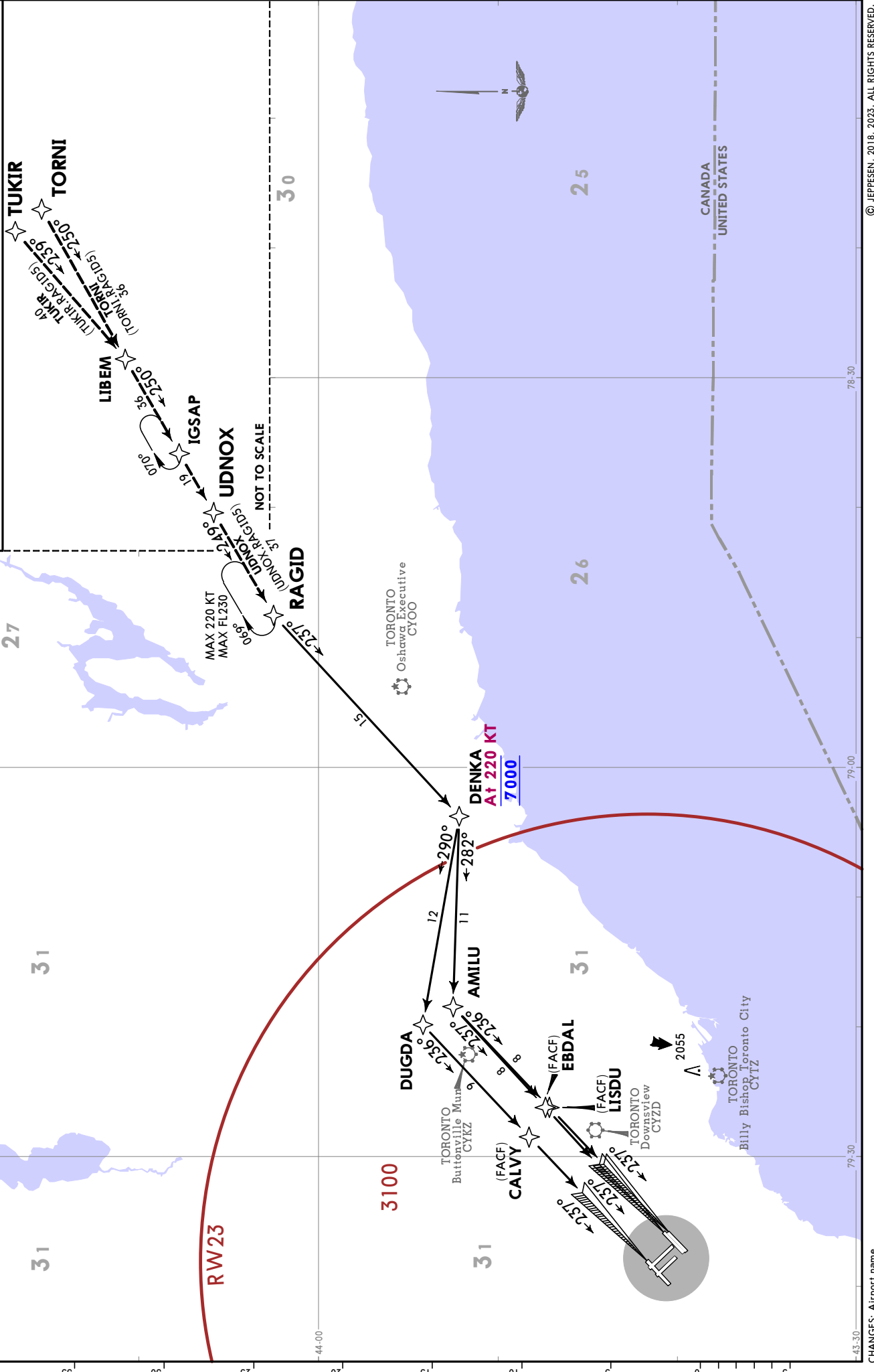

UDNOX 5 ARRIVAL
 (RAGID.UDNOX5)
 (RWYS 05, 06L/R)

Alt Set: INCHES	Trans level: FL180
RNAV 1 - D/D/1 or GNSS required	
1. Safe Altitude within 100 NM 4900.	
2. Non-Jet aircraft only.	
3. TUKIR transition: For non GNSS equipped aircraft, YXI DME must be operational.	
D-ATIS	Apt Elev
120.825	569
133.1	

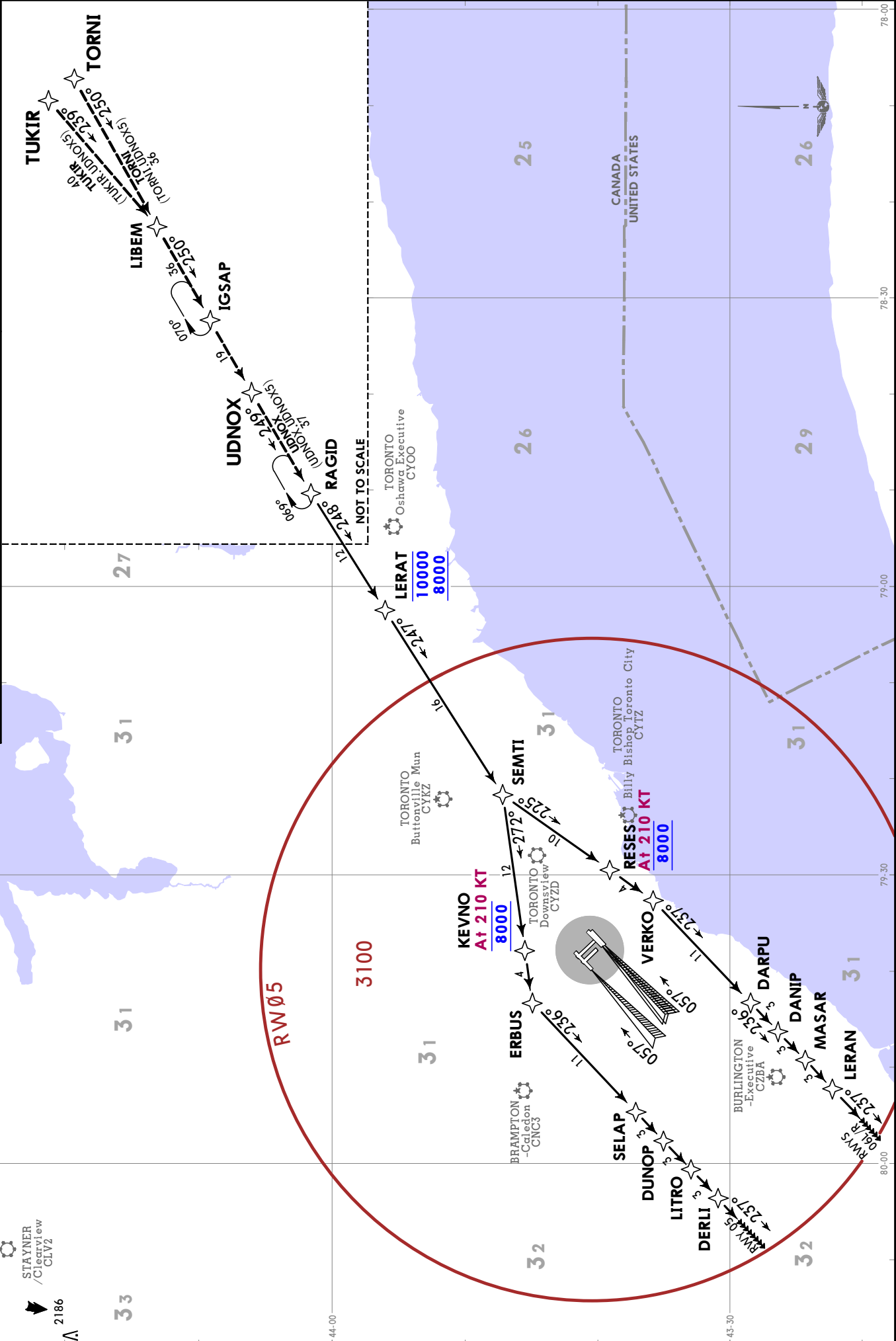

JEPPESEN
28 APR 23 (10-2G1) **RNAV STAR**

CYYZ/YYZ
LESTER B PEARSON INTL

TORONTO, ONT
RNAV STAR

D-ATIS 120.825 133.1	Apt Elev 569	Alt Set: INCHES Trans level: FL180
UDNOX 5 ARRIVAL (RAGID.UDNOX5) (RWYS 15L/R)		RNAV 1 - D/D/1 or GNSS required
1. Safe Altitude within 100 NM 4900. 2. Non-Jet aircraft only. 3. TUKIR transition: For non GNSS equipped aircraft, YXI DME must be operational.		



UDNOX 5 ARRIVAL
 (RAGID.UDNOX5)
 (RWYS 23, 24L/R)

Alt Set: INCHES Trans level: FL180
 RNAV 1 - D/D/1 or GNS required
 1. Safe Altitude within 100 NM 4900.
 2. Non-Jet aircraft only.
 3. TUKIR transition: For non GNS equipped aircraft, YXI DME must be operational.

D-ATIS
 120.825 133.1
 Apt Elev
 569

CYYZ/YYZ
LESTER B PEARSON INTL



JEPPESEN
28 APR 23 (10-2G3)

TORONTO, ONT
RNAV STAR

CYYZ/YYZ
LESTER B PEARSON INTL

D-ATIS 120.825 133.1	Apt Elev 569	Alt Set: INCHES Trans level: FL180
		RNAV 1 - D/D/I or GNSS required
1. Safe Altitude within 100 NM 4900. 2. Non-Jet aircraft only. 3. TUKIR transition: For non GNSS equipped aircraft, YX1 DME must be operational.		
UDNOX 5 ARRIVAL (RAGID.UDNOX5) (RWYS 33L/R)		

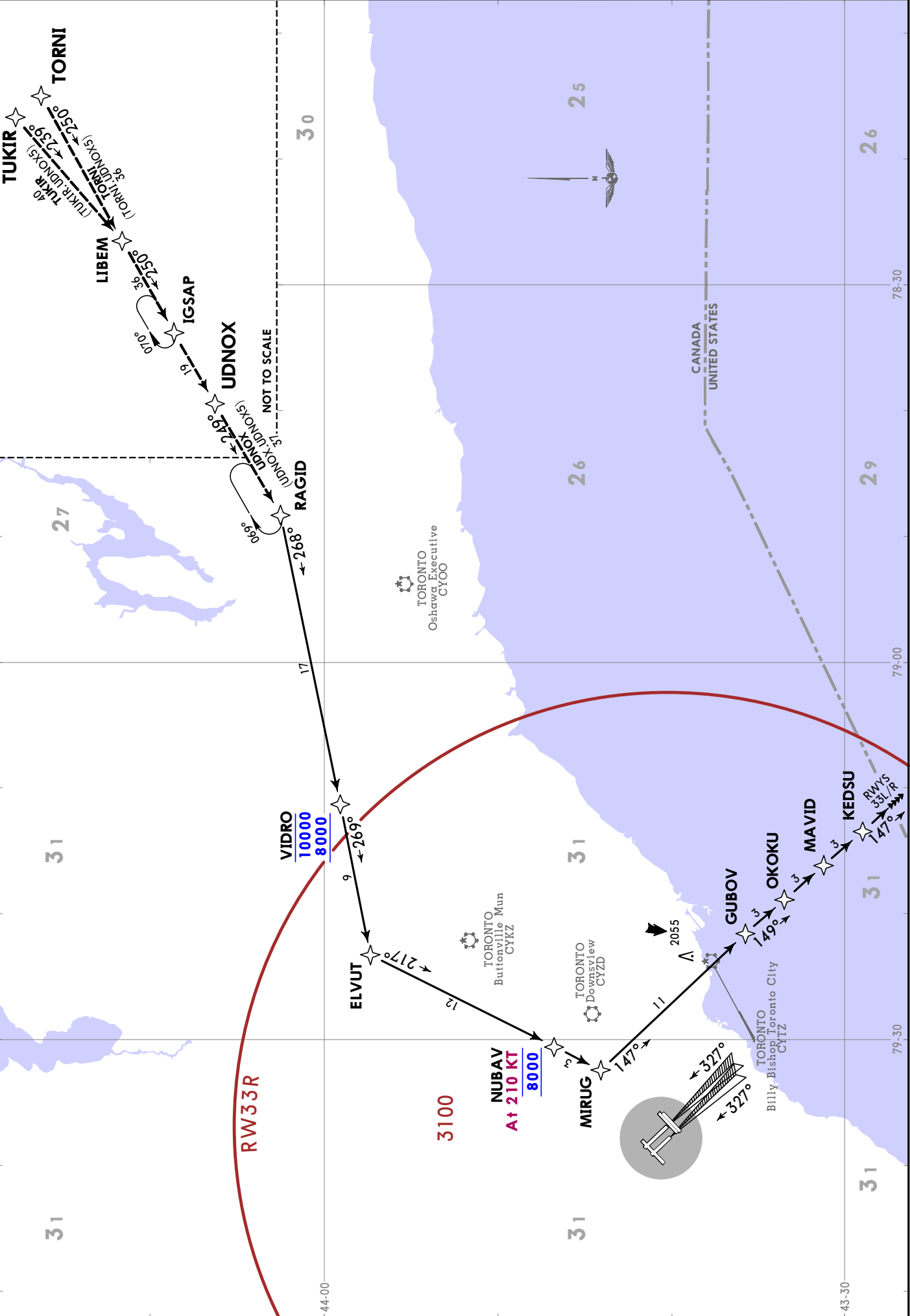

CHANGES: Airport name.

CYYZ/YYZ
LESTER B PEARSON INTL

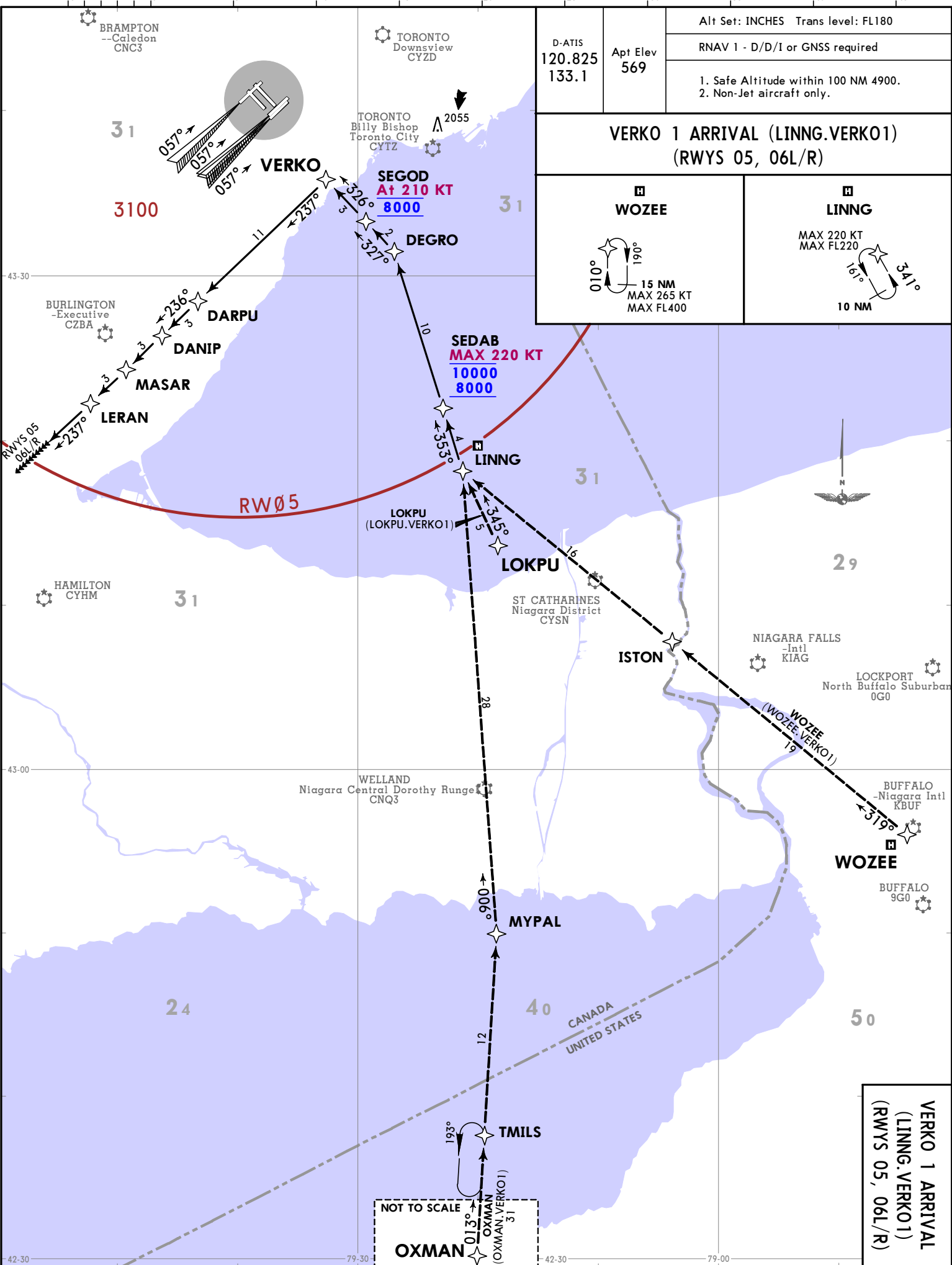

D-ATIS 120.825 133.1	Apt Elev 569	Alt Set: INCHES Trans level: FL180
RNAV 1 - D/D/I or GNSS required		
1. Safe Altitude within 100 NM 4900. 2. Non-Jet aircraft only.		

**VERKO 1 ARRIVAL (LINNG.VERKO1)
(RWYS 05, 06L/R)**

WOZEE

15 NM
MAX 265 KT
MAX FL400

LINNG

10 NM
MAX 220 KT
MAX FL220

**VERKO 1 ARRIVAL
(LINNG.VERKO1)
(RWYS 05, 06L/R)**

CHANGES: Airport name.

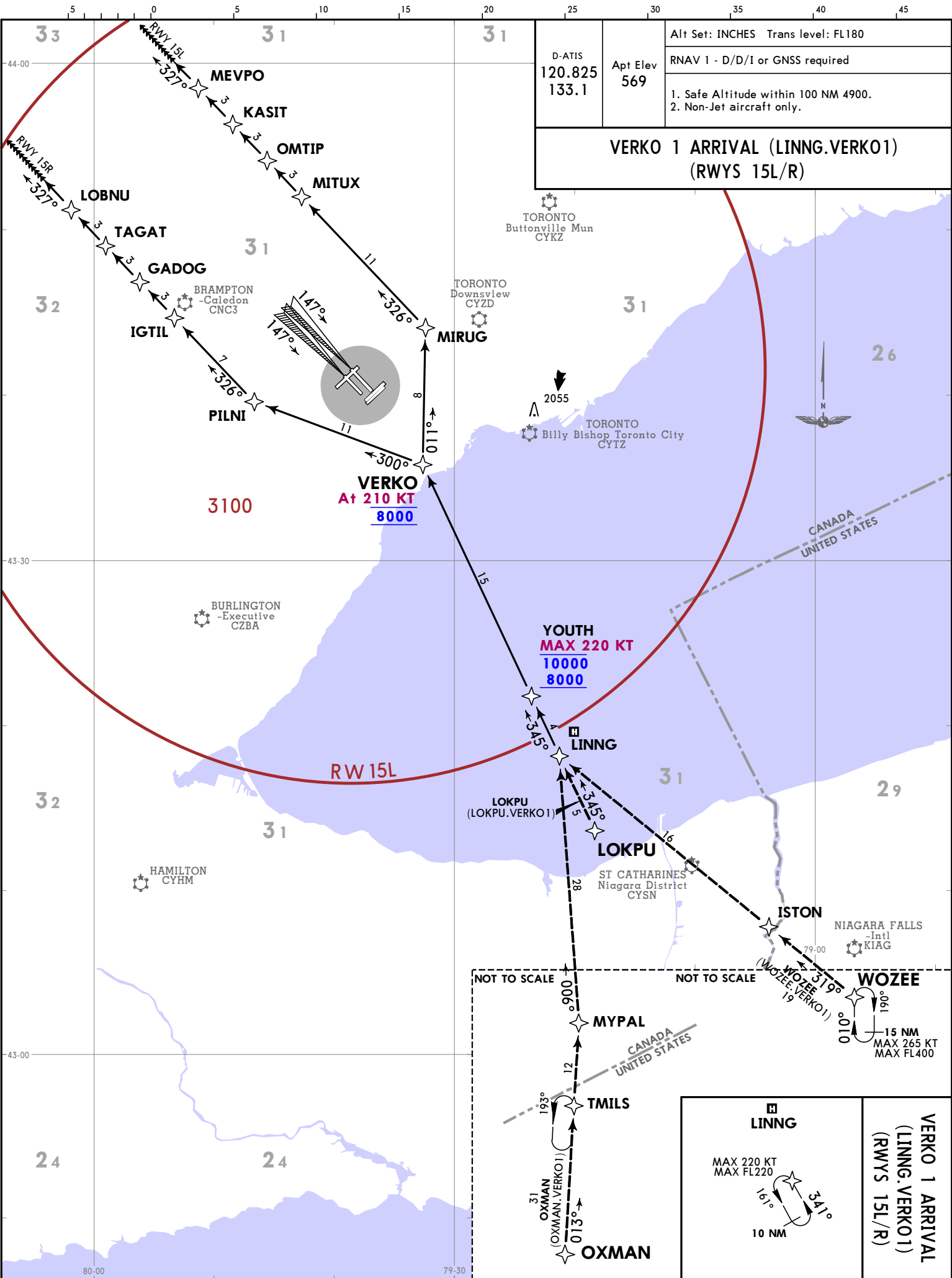

D-ATIS 120.825 133.1	Apt Elev 569	Alt Set: INCHES Trans level: FL180
RNAV 1 - D/D/I or GNSS required		
1. Safe Altitude within 100 NM 4900. 2. Non-Jet aircraft only.		
VERKO 1 ARRIVAL (LINNG.VERKO1) (RWYS 15L/R)		

YOUTH
MAX 220 KT
10000
8000

WOZEE
15 NM
MAX 265 KT
MAX FL400

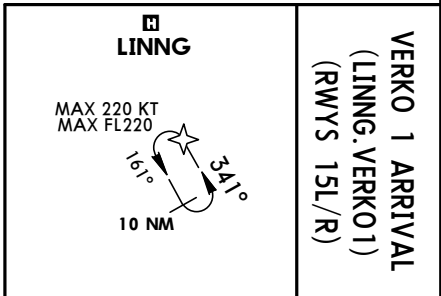

CYZ/YYZ
LESTER B PEARSON INTL

28 APR 23 (0-2H1)
JEPPESSEN

TORONTO, ONT
RNAV STAR

© JEPPESSEN, 2018, 2023. ALL RIGHTS RESERVED.

CHANGES: Airport name.

CYYZ/YYZ
LESTER B PEARSON INTL

D-ATIS 120.825 133.1	Apt Elev 569	Alt Set: INCHES Trans level: FL180
		RNAV 1 - D/D/I or GNSS required

1. Safe Altitude within 100 NM 4900.
2. Non-Jet aircraft only.

VERKO 1 ARRIVAL (LINNG.VERKO1)
(RWYS 23, 24L/R)

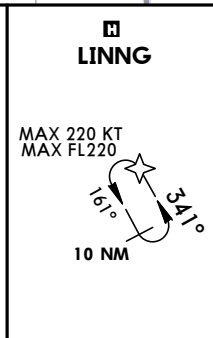
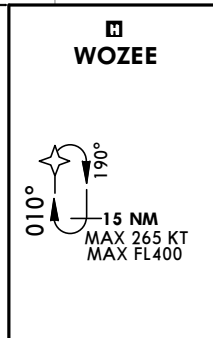
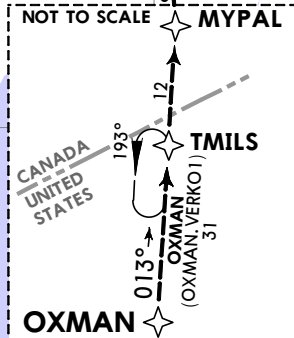
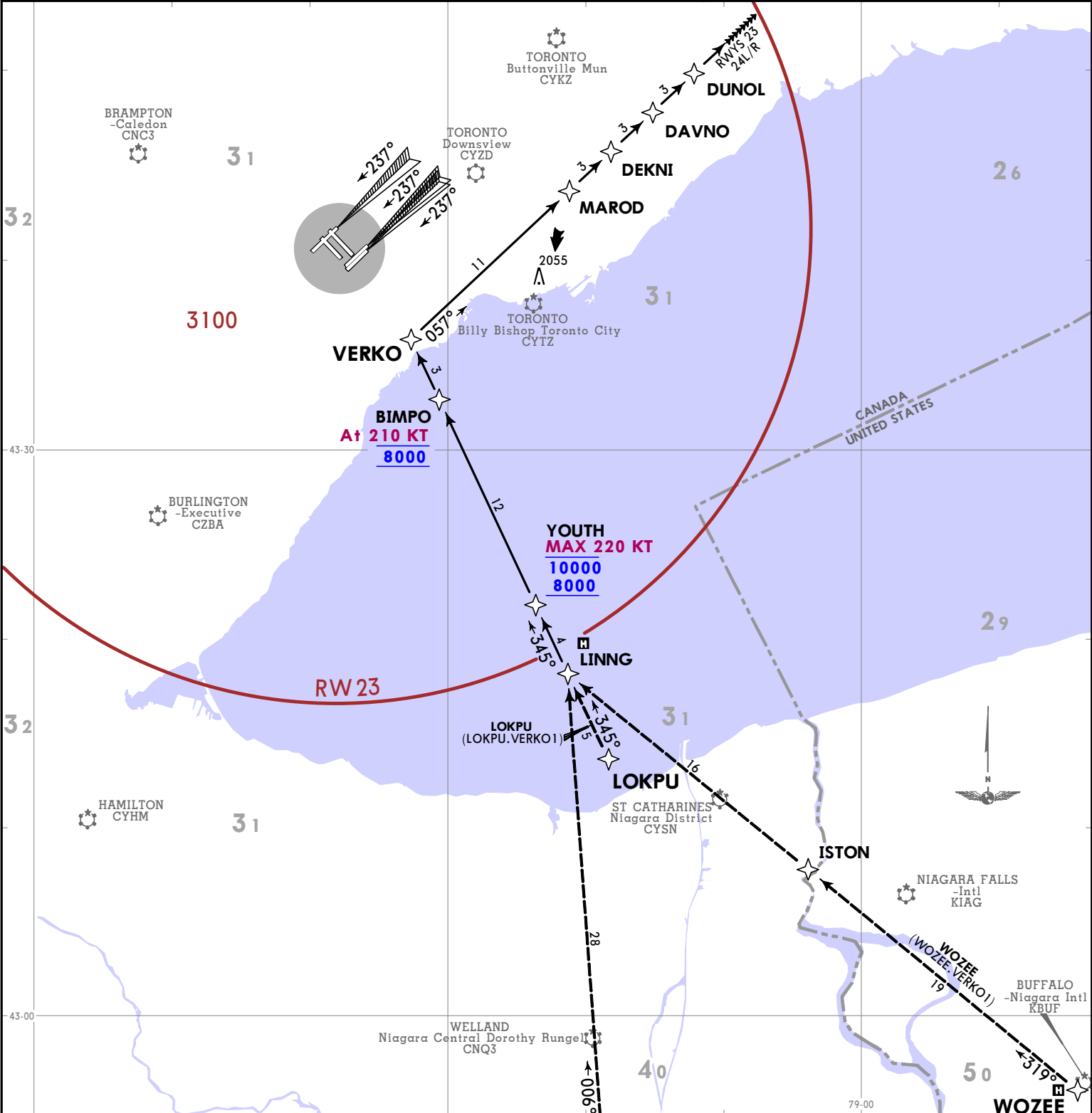

VERKO 1 ARRIVAL
(LINNG.VERKO1)
(RWYS 23, 24L/R)

© JEPPESSEN, 2018, 2023. ALL RIGHTS RESERVED.

CHANGES: Airport name.

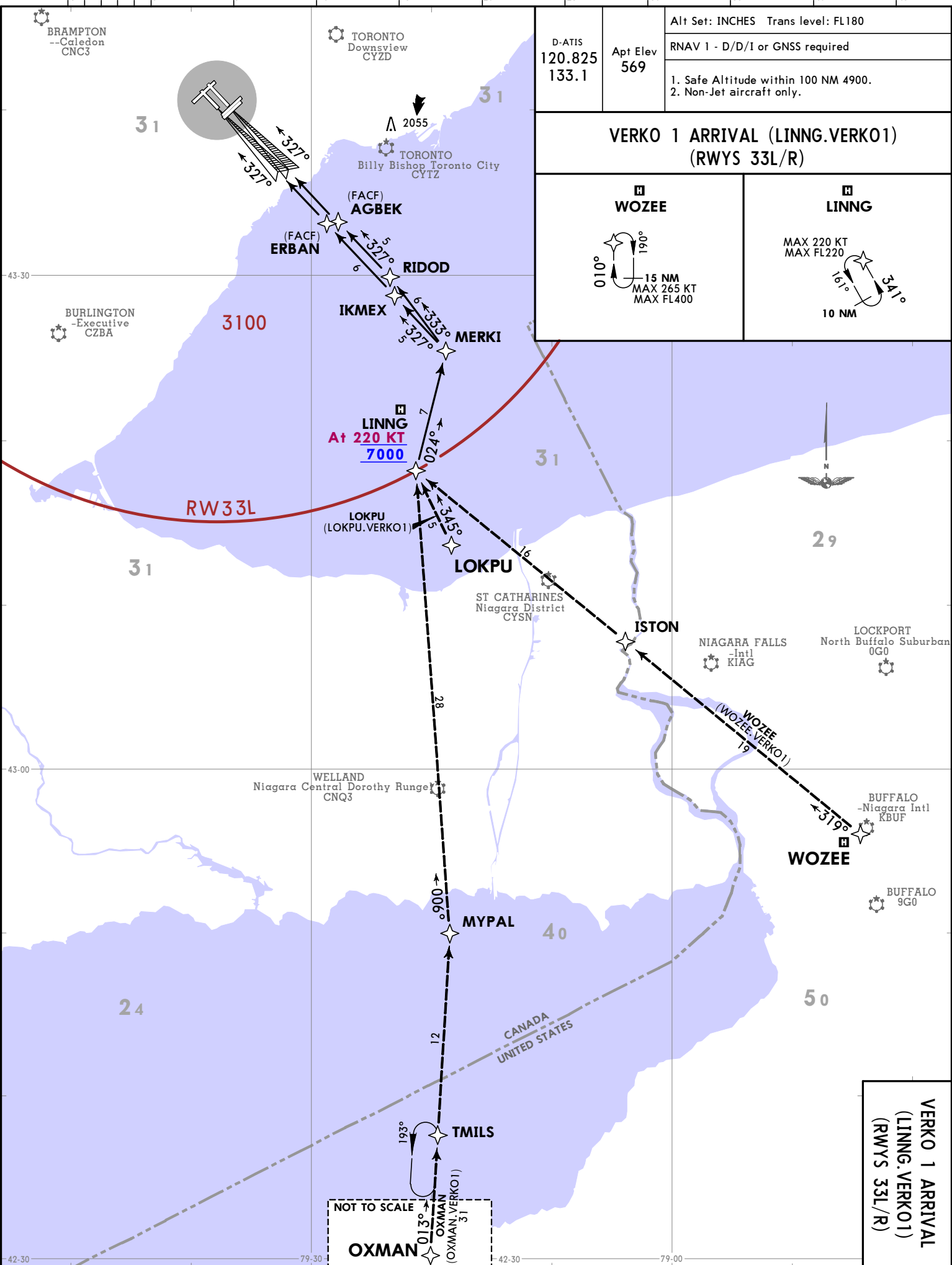

CYYZ / YYZ
LESTER B PEARSON INTL

JEPPESSEN
28 APR 23 10-2H3

TORONTO, ONT
RNAV STAR

© JEPPESSEN, 2018, 2023. ALL RIGHTS RESERVED.

JEPPESEN TORONTO, ONT
RNAV STAR

28 APR 23 (10-2J)
 D-ATIS 120.825 133.1
 Apt Elev 569
 Alt Set: INCHES Trans level: FL180
 RNAV 1 - D/D/1 or GNSS required
 1. Safe Altitude within 100 NM 4900.
 2. Non-Jet aircraft only.
 3. LETAK and TUKIR transitions: For non GNSS equipped aircraft, YOW DME must be operational.

VIBLI 6 ARRIVAL
(IMEBA.VIBLI6)
(RWYS 05, 06L/R)

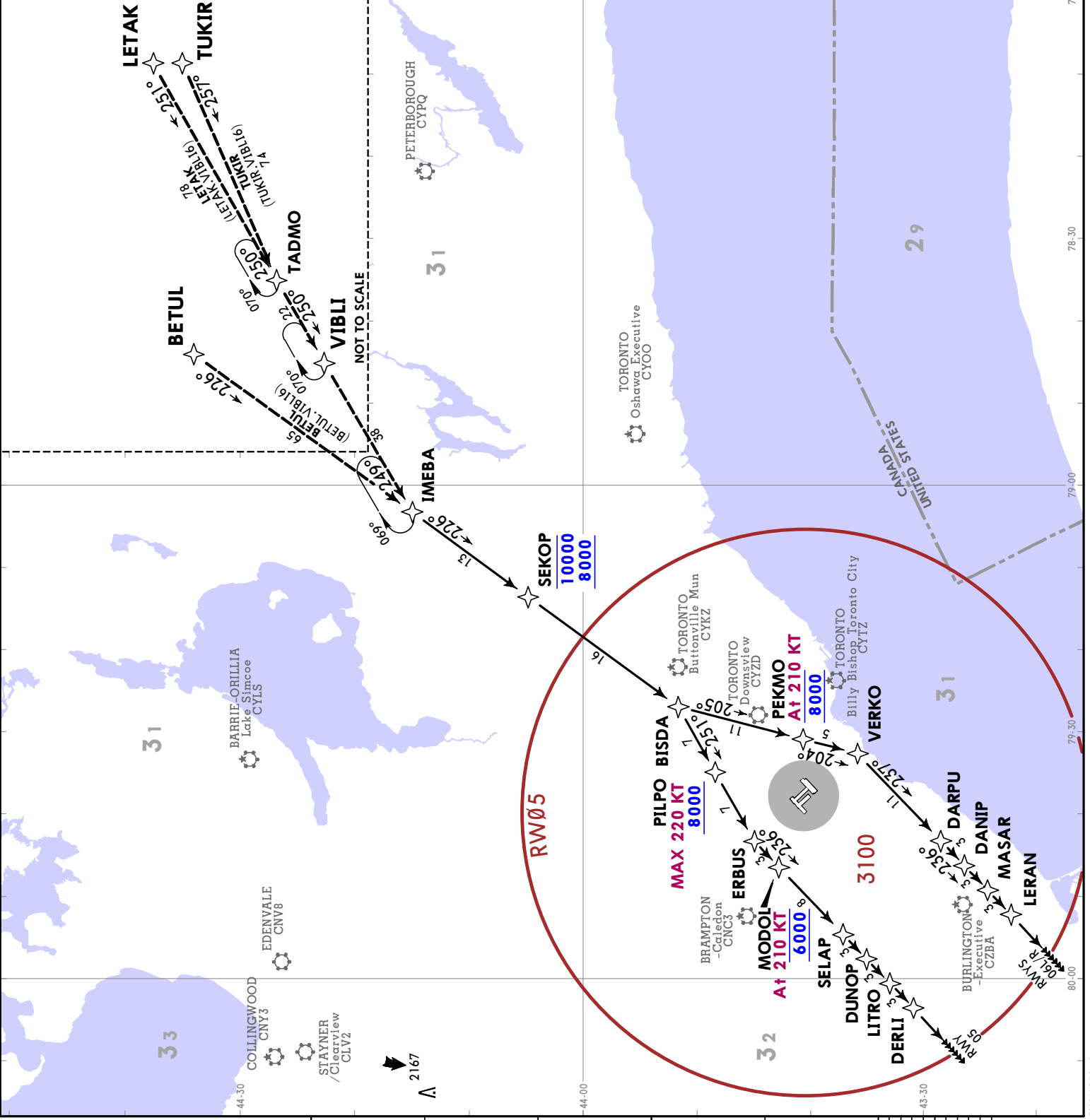

JEPPesen
 28 APR 23 (10-2J1)
TORONTO, ONT
RNAV STAR

CYYZ/YYZ
LESTER B PEARSON INTL

D-ATIS 120.825 133.1	Alt Set: INCHES Trans level: FL180
Apt Elev 569	RNAV 1 - D/D/I or GNSS required
	1. Safe Altitude within 100 NM 4900. 2. Non-Jet aircraft only. 3. LETAK and TUKIR transitions: For non GNSS equipped aircraft, YOW DME must be operational.

VIBLI 6 ARRIVAL
(IMEBA, VIBLI6)
(RWYS 15L/R)

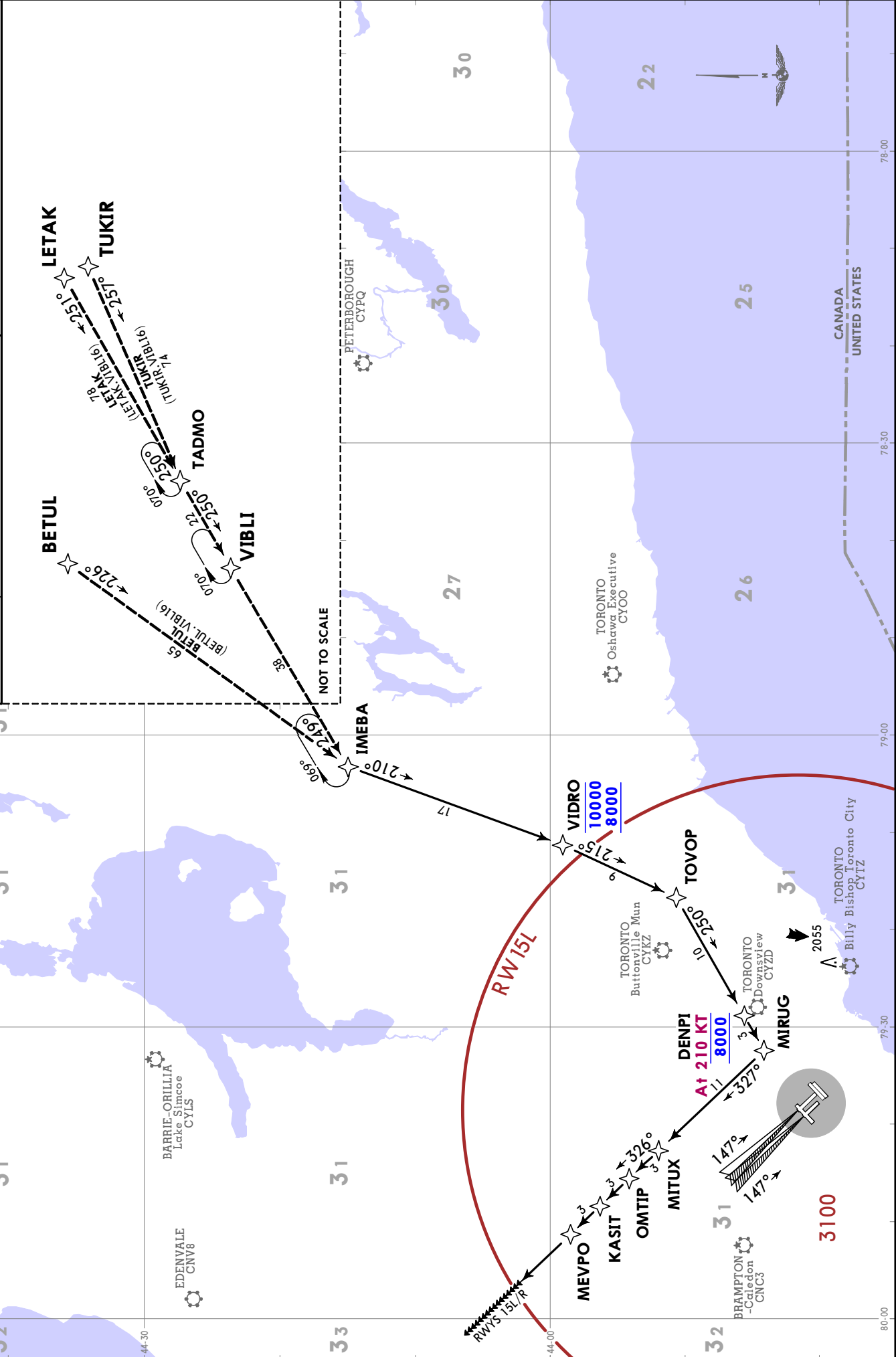

VIBLI 6 ARRIVAL (IMEBA.VIBLI6)
(RWYS 23, 24L/R)

D-ATIS 120.825 133.1	Apt Elev 569	Alt Set: INCHES Trans level: FL180
RNAV 1 - D/D/I or GNSSE required		
1. Safe Altitude within 100 NM 4900. 2. Non-Jet aircraft only. 3. LETAK and TUKIR transitions: For non GNSSE equipped aircraft, YOW DME must be operational.		

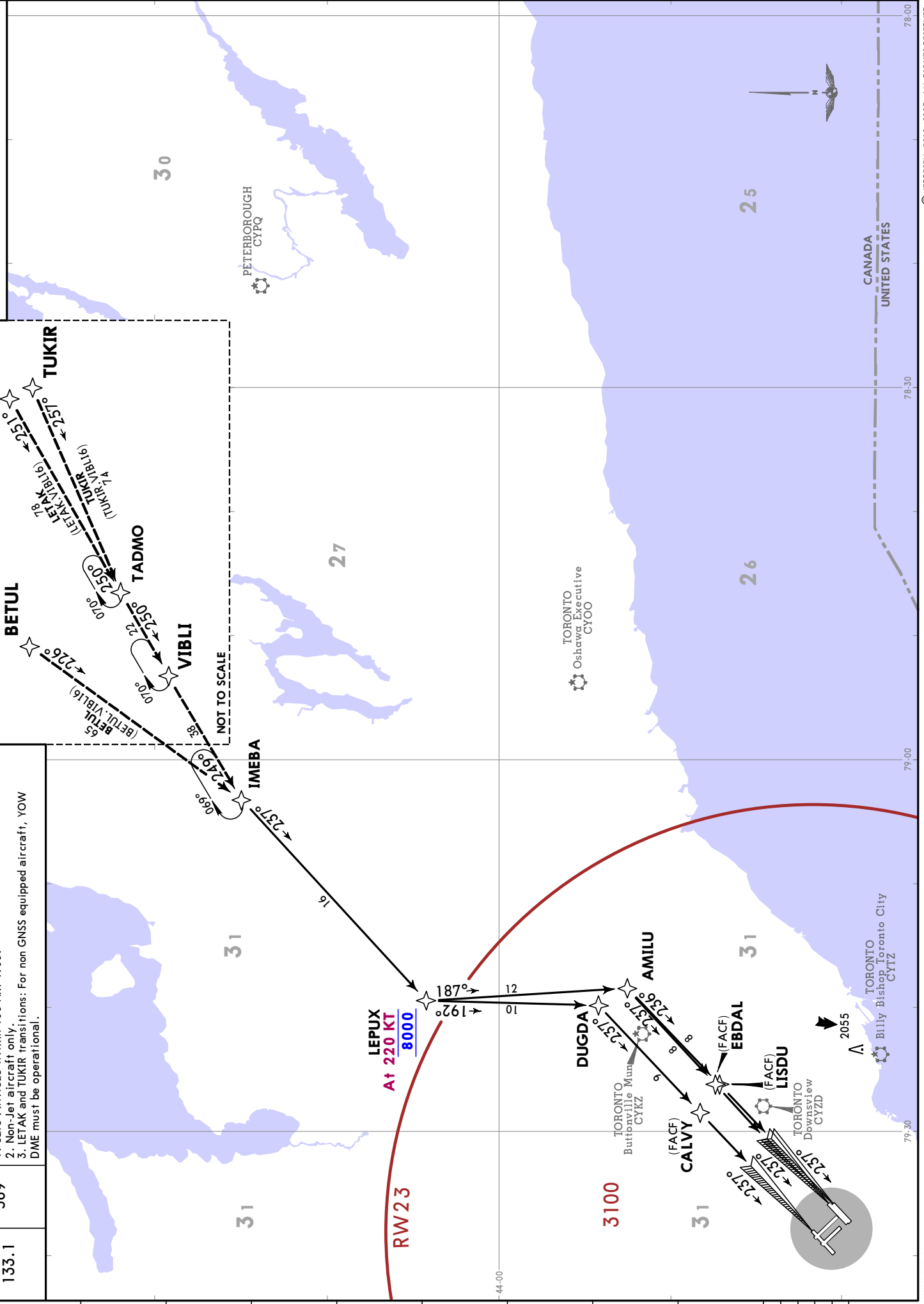

JEPPESEN
 28 APR 23 (10-2J3)
RNAV STAR

CYYZ/YYZ
 LESTER B PEARSON INTL

TORONTO, ONT
RNAV STAR

VIBLI 6 ARRIVAL (IMEBA.VIBLI6)
(RWYS 33L/R)

1. Safe Altitude within 100 NM 4900.
 2. Non-Jet aircraft only.
 3. LETAK and TUKIR transitions: For non GNSS equipped aircraft, YOW DME must be operational.

Alt Set: INCHES Trans level: FL180

RNAV 1 - D/D/I or GNSS required

D-ATIS
 120.825
 133.1

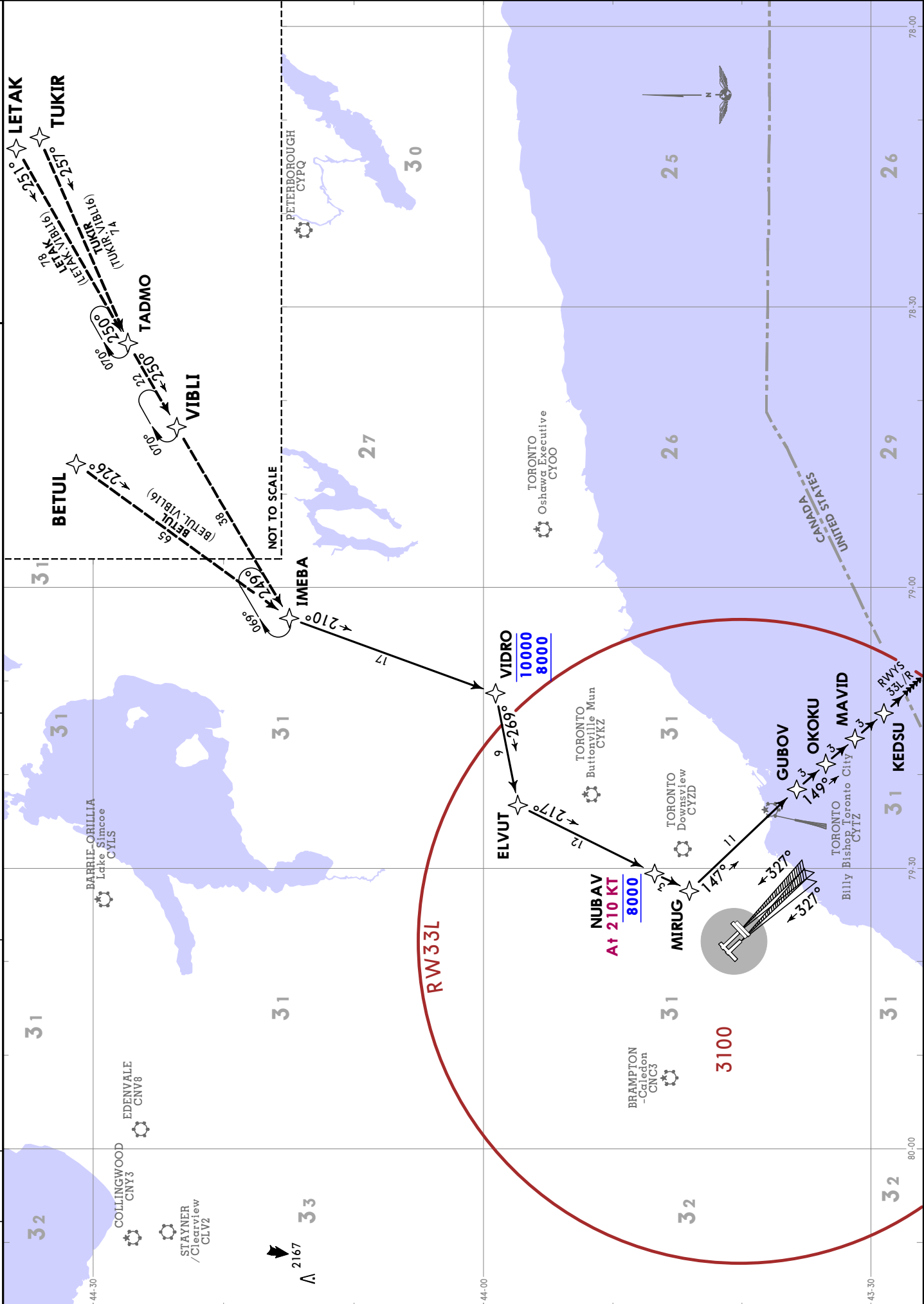

JEPPesen TORONTO, ONT
RNAV SID

CYYZ/YYZ
LESTER B PEARSON INTL

28 APR 23 (10-3)

TORONTO Departure
 128.8 127.575
 Apt Elev 569

Trans alt: 18000

1. RADAR required.
 2. CAUTION: Rws 05, 06L/R, 23, 24L/R departures in use.
 3. Safe Altitude within 100 NM 4900.
 4. Jet aircraft only.
 5. For use by GNS5 or D/D/1 equipped aircraft.
 Aircraft with selectable CDI must be set to 1 NM sensitivity. Aircraft without selectable CDI must use flight director.
 6. Refer to 10-4 Noise Abatement Procedures for additional requirements.

ANCOL 5 DEPARTURE (ANCOL5.)
(RWYS 05, 06L/R, 23, 24L/R)

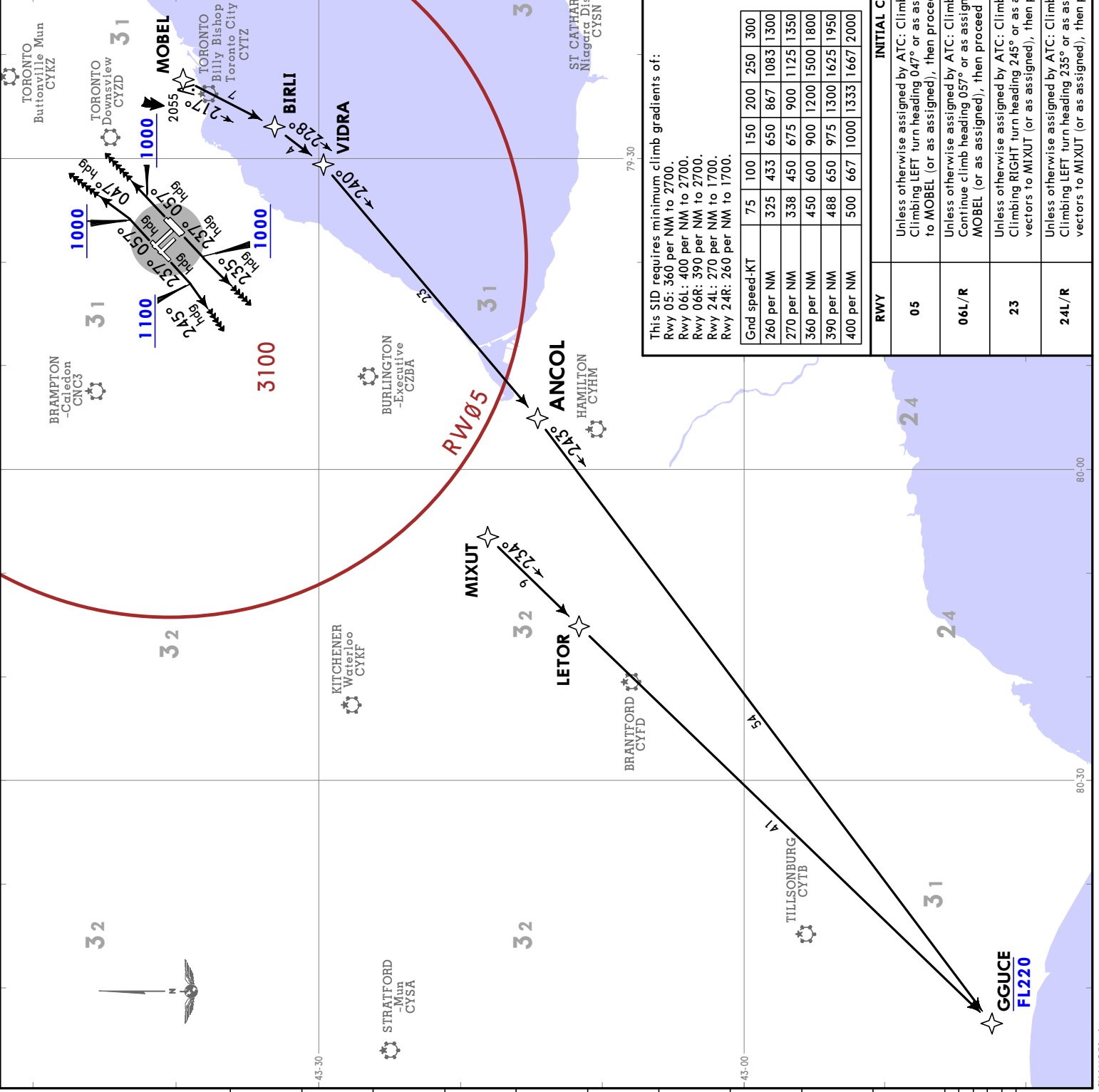

CYYZ/YYZ
LESTER B PEARSON INTL

JEPPESEN
28 APR 23 **(10-3A1)**

TORONTO, ONT
SID

TORONTO Departure 128.8 127.575	Apt Elev 569	Trans alt: 18000 1. Safe Altitude within 100 NM 4900. 2. CAUTION: Rwy 05, 06L/R, 23, 24L/R departures: Simultaneous parallel departures in use. 3. Refer to 10-4 Noise Abatement Procedures for additional requirements.
--	------------------------	---

ARROW 4 DEPARTURE (ARROW4.) (VECTOR)
Quiet Hours Procedure. For use between 0000-0630 local.
SPEED: MAX 250 KT BELOW 10000

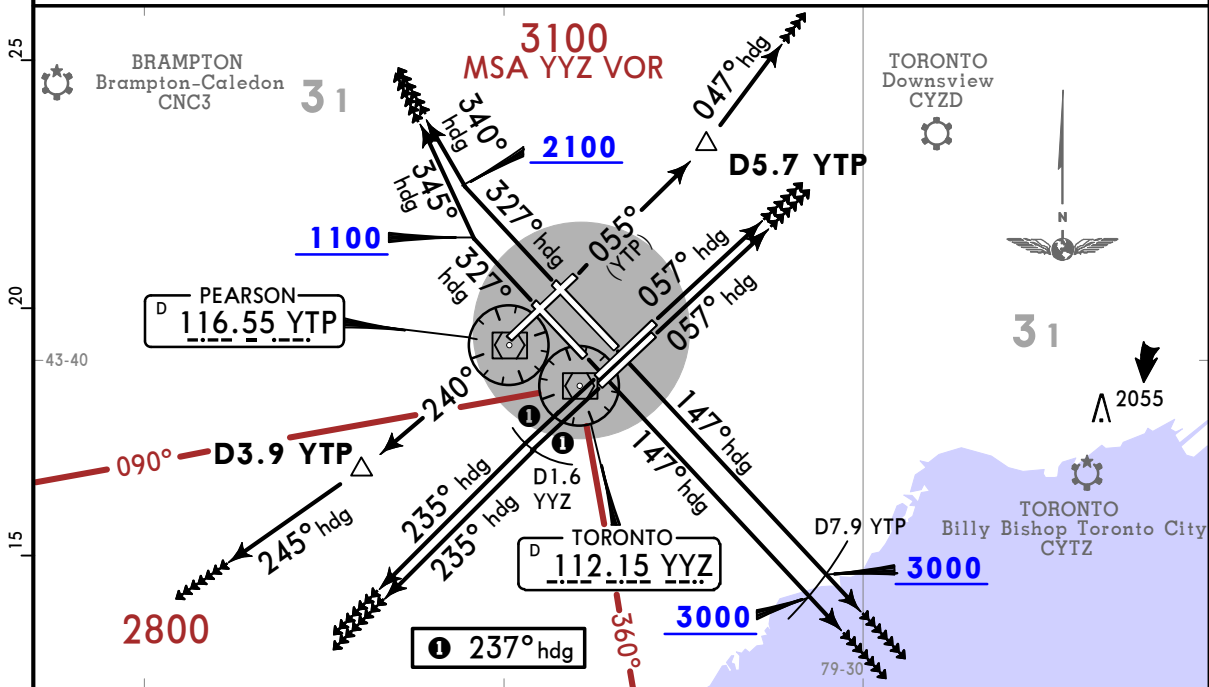

TURBOJET/FAN AIRCRAFT ONLY	
RWY	NOISE ABATEMENT DEPARTURE PROCEDURE
ALL RWYS	1 or 2

This SID requires minimum climb gradients of:

- Rwy 05: 360 per NM to 2700.
- Rwy 06L: 400 per NM to 2700.
- Rwy 06R: 390 per NM to 2700.
- Rwy 15L: 390 per NM to 3000.
- Rwy 15R: 380 per NM to 3000.
- Rwy 24L: 270 per NM to 1700.
- Rwy 24R: 260 per NM to 1700.
- Rwy 33L: 250 per NM to 900.

LOST COMMS ▼ LOST COMMS ▼ LOST COMMS ▼ LOST COMMS ▼

On recognition of a failure 20 minutes or less after take-off and in IFR weather conditions, proceed as follows:

1. Select transponder code 7600;
2. Beyond D10.0 YYZ proceed directly on course;
3. Do not climb above last assigned altitude for 5 minutes after recognition of failure, then;
4. Climb to flight plan altitude.

LOST COMMS ▲ LOST COMMS ▲ LOST COMMS ▲ LOST COMMS ▲ LOST

Gnd speed-KT	75	100	150	200	250	300
250 per NM	313	417	625	833	1042	1250
260 per NM	325	433	650	867	1083	1300
270 per NM	338	450	675	900	1125	1350
360 per NM	450	600	900	1200	1500	1800
380 per NM	475	633	950	1267	1583	1900
390 per NM	488	650	975	1300	1625	1950
400 per NM	500	667	1000	1333	1667	2000

① Unless otherwise assigned by ATC.

RWY	① INITIAL CLIMB	① ALTITUDE
05	Intercept and MAINTAIN YTP R055 outbound. At D5.7 YTP fly heading 047° or assigned heading for vectors to assigned route.	Jet aircraft MAINTAIN 5000. Non-jet aircraft MAINTAIN 3000. Aircraft assigned a turn at takeoff; commence turn at 1100
06L/R	Climb heading 057° or assigned heading for vectors to assigned route.	
15L/R	Climb heading 147° cross D7.9 YTP at or above 3000. MAINTAIN heading for vectors to assigned route.	
23	Climb heading 237° until passing YTP VOR. Then intercept and MAINTAIN YTP R240 outbound. At D3.9 YTP fly heading 245° or assigned heading for vectors to assigned route.	
24L/R	Climb heading 237°. At D1.6 YYZ, turn LEFT heading 235° or assigned heading for vectors to assigned route.	
33L	Climb heading 327° to 1100. Climbing RIGHT turn heading 345° or assigned heading for vectors to assigned route.	
33R	Climb heading 327° to 2100. Climbing RIGHT turn heading 340° or assigned heading for vectors to assigned route.	

JEPPESEN
CYYZ/YYZ
LESTER B PEARSON INTL
 28 APR 23
10-3A3
RNAV SID

TORONTO, ONT

Trans alt: 18000
 1. RADAR required.
 2. Safe Altitude within 100 NM 4900.
 3. Jet aircraft only.
 4. For use by GNS5 or D/D/1 equipped aircraft. Aircraft with a selectable CDI must be set to 1 NM sensitivity. Aircraft without selectable CDI must use flight director.
 5. Refer to 10-4 Noise Abatement Procedures for additional requirements.

TORONTO
 Departure
 128.8
 127.575

Apt Elev
 569

AVSEP 7 DEPARTURE (AVSEP7.)
(RWYS 15L/R, 33L/R)

OTNIK ☆
 (AVSEP7-OTNIK)
 30
 315°

NAKAL ☆
 28
 316°

GOPAK ☆
 58
 339°

MUSIT ☆
 (AVSEP7-MUSIT)
 35

PEPMA ☆

NUGOP ☆
 77
 322°

URSAL ☆
 22
 334°

AVSEP ☆
 13
 317°

TETAD ☆
 17
 325°

IPSOT ☆
 7
 322°

VIBNA ☆
 7
 322°

BOVAL ☆
 7
 293°

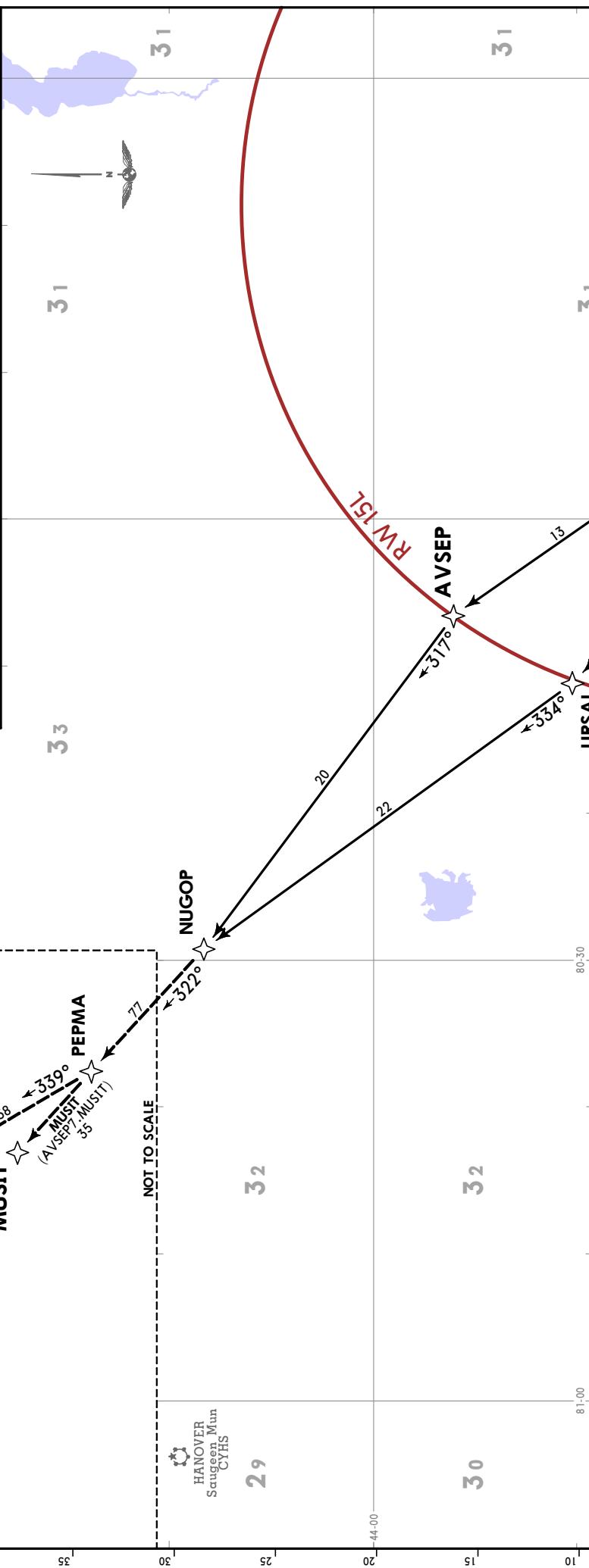

NOT TO SCALE

HANOVER Saugeen Mtn CYHS

BRAMPTON-Caledon CNC3

TORONTO Downsview CYZD

80-00

81-00

80-30

81-30

44-00

45-00

40-00

35-00

30-00

This SID requires minimum climb gradients of:

Rwy 15L: 390 per NM to 3000.
 Rwy 15R: 380 per NM to 3000.
 Rwy 33L: 250 per NM to 900.

Gnd speed-KT	75	100	150	200	250	300
250 per NM	313	417	625	833	1042	1250
380 per NM	475	633	950	1267	1583	1900
390 per NM	488	650	975	1300	1625	1950

LOST COMMS

On recognition of failure 20 minutes or less after take-off and in IFR weather conditions proceed as follows:

- Select transponder code 7600.
- Beyond 10 NM from CYYZ, proceed directly on course.
- Do not climb above last assigned altitude for 5 minutes after recognition of failure.
- Climb to flight planned altitude.

RWY	INITIAL CLIMB	ALTITUDE
15L/R	Unless otherwise assigned by ATC: Climb heading 147° to 1000. Continue climb heading 147° or as assigned. EXPECT RADAR vectors to BOVAL (or as assigned), then proceed via depicted route.	Unless otherwise assigned by ATC: MAINTAIN 5000.
33L	Unless otherwise assigned by ATC: Climb heading 327° to 1100. Climbing RIGHT turn heading 345° or as assigned. EXPECT RADAR vectors to TETAD (or as assigned), then proceed via depicted route.	
33R	Unless otherwise assigned by ATC: Climb heading 327° to 2100. Climbing RIGHT turn heading 340° or as assigned. EXPECT RADAR vectors to TETAD (or as assigned), then proceed via depicted route.	

CHANGES: Airport name.

© JEPPESEN, 2018, 2023. ALL RIGHTS RESERVED.

CHANGES: Airport name.

CYYZ/YYZ
LESTER B PEARSON INTL

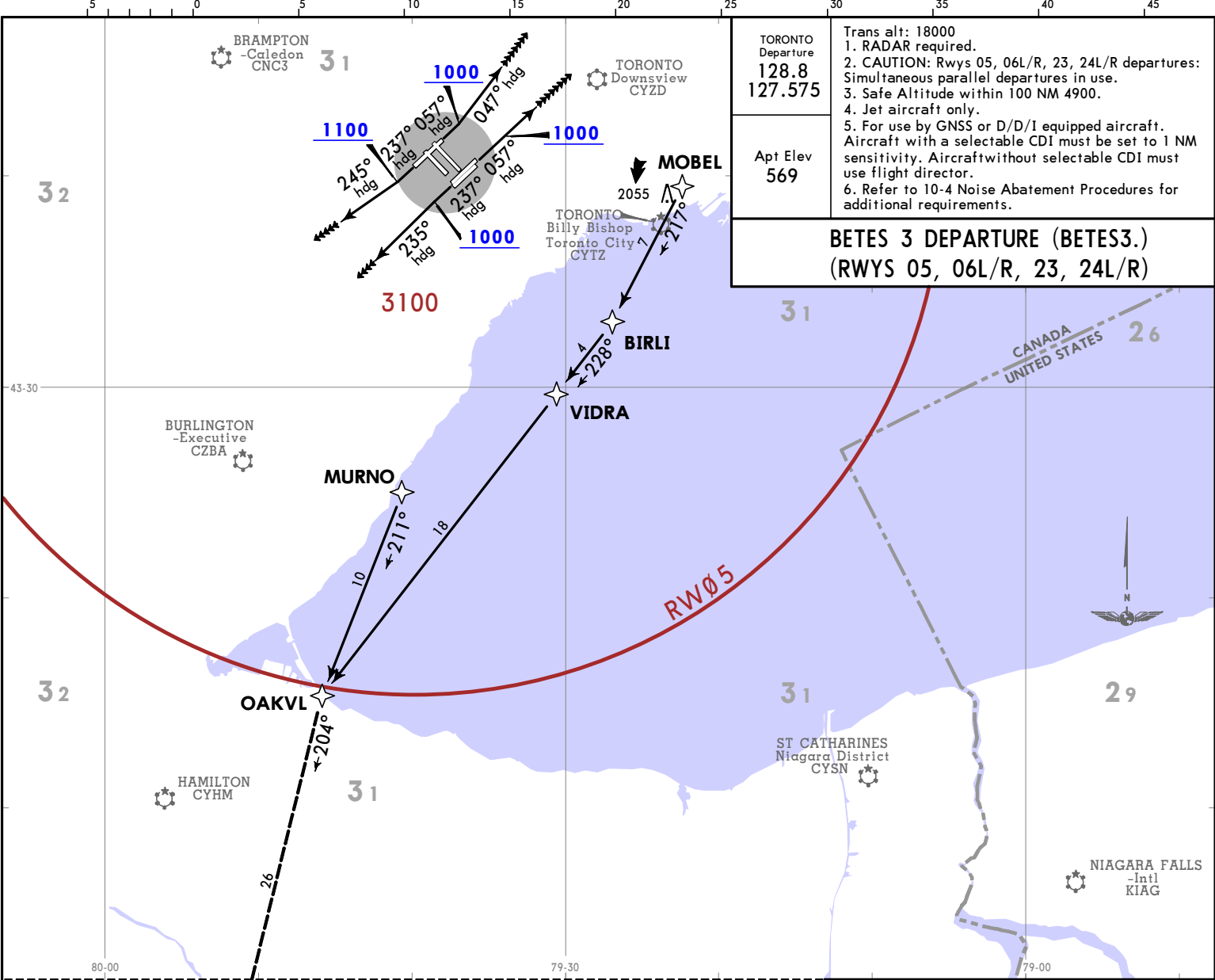

TORONTO Departure 128.8 127.575	Trans alt: 18000 1. RADAR required. 2. CAUTION: Rwy 05, 06L/R, 23, 24L/R departures: Simultaneous parallel departures in use. 3. Safe Altitude within 100 NM 4900. 4. Jet aircraft only. 5. For use by GNSS or D/D/I equipped aircraft. Aircraft with a selectable CDI must be set to 1 NM sensitivity. Aircraft without selectable CDI must use flight director. 6. Refer to 10-4 Noise Abatement Procedures for additional requirements.
Apt Elev 569	

BETES 3 DEPARTURE (BETES3.)
(RWYS 05, 06L/R, 23, 24L/R)

NOT TO SCALE

- LOST COMMS
- On recognition of failure 20 minutes or less after take-off and in IFR weather conditions proceed as follows:
1. Select transponder code 7600.
 2. Beyond 10 NM from CYYZ proceed directly on course.
 3. Do not climb above last assigned altitude for 5 minutes after recognition of failure.
 4. Climb to flight planned altitude.
- LOST COMMS

This SID requires minimum climb gradients of:

Rwy 05: 360 per NM to 2700.
Rwy 06L: 400 per NM to 2700.
Rwy 06R: 390 per NM to 2700.
Rwy 24L: 270 per NM to 1700.
Rwy 24R: 260 per NM to 1700.

Gnd speed-KT	75	100	150	200	250	300
260 per NM	325	433	650	867	1083	1300
270 per NM	338	450	675	900	1125	1350
360 per NM	450	600	900	1200	1500	1800
390 per NM	488	650	975	1300	1625	1950
400 per NM	500	667	1000	1333	1667	2000

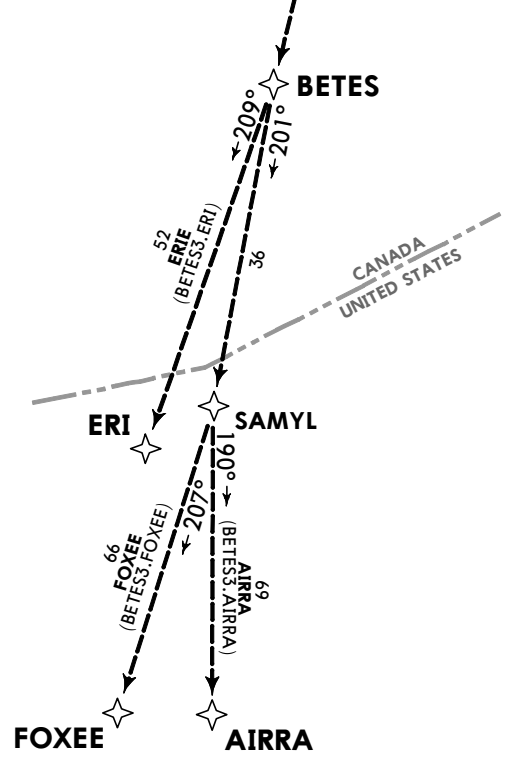

RWY	INITIAL CLIMB	ALTITUDE
05	Unless otherwise assigned by ATC: Climb heading 057° to 1000. Climbing LEFT turn heading 047° or as assigned. EXPECT RADAR vectors to MOBEL (or as assigned), then proceed via depicted route.	Unless otherwise assigned by ATC: MAINTAIN 5000
06L/R	Unless otherwise assigned by ATC: Climb heading 057° to 1000. Continue climb heading 057° or as assigned. EXPECT RADAR vectors to MOBEL (or as assigned), then proceed via depicted route.	
23	Unless otherwise assigned by ATC: Climb heading 237° to 1100. Climbing RIGHT turn heading 245° or as assigned. EXPECT RADAR vectors to MURNO (or as assigned), then proceed via depicted route.	
24L/R	Unless otherwise assigned by ATC: Climb heading 237° to 1000. Climbing LEFT turn heading 235° or as assigned. EXPECT RADAR vectors to MURNO (or as assigned), then proceed via depicted route.	

BETES 3 DEPARTURE (BETES3.)
(RWYS 05, 06L/R, 23, 24L/R)

28 APR 23 10-3B
JEPPESSEN TORONTO, ONT
RNAV SID

CHANGES: Airport name.

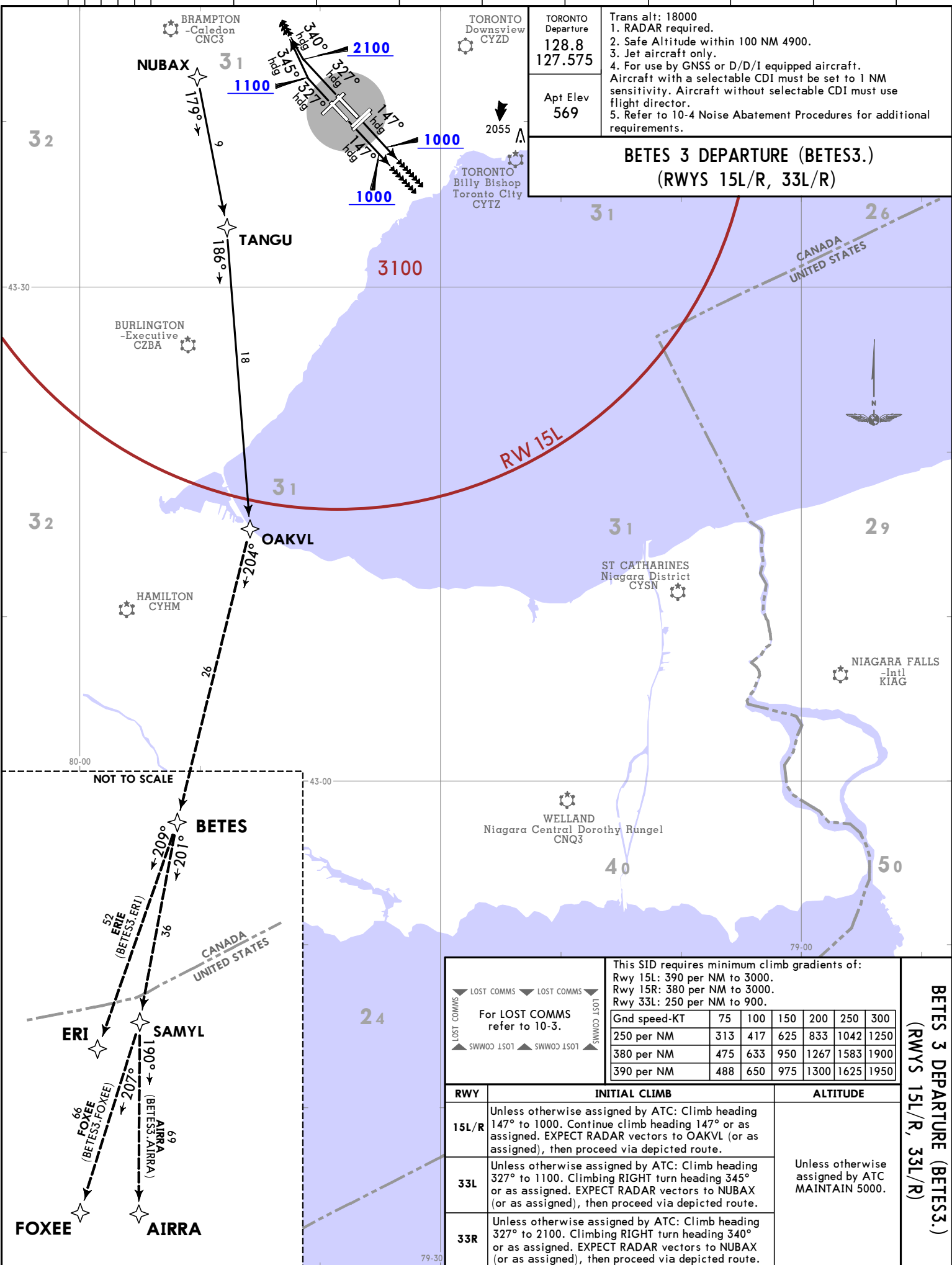

TORONTO Departure 128.8 127.575	Trans alt: 18000 1. RADAR required. 2. Safe Altitude within 100 NM 4900. 3. Jet aircraft only. 4. For use by GNSS or D/D/I equipped aircraft. Aircraft with a selectable CDI must be set to 1 NM sensitivity. Aircraft without selectable CDI must use flight director. 5. Refer to 10-4 Noise Abatement Procedures for additional requirements.
Apt Elev 569	

BETES 3 DEPARTURE (BETES3.)
(RWYS 15L/R, 33L/R)

This SID requires minimum climb gradients of:

Rwy 15L:	390 per NM to 3000.
Rwy 15R:	380 per NM to 3000.
Rwy 33L:	250 per NM to 900.

Gnd speed-KT	75	100	150	200	250	300
250 per NM	313	417	625	833	1042	1250
380 per NM	475	633	950	1267	1583	1900
390 per NM	488	650	975	1300	1625	1950

RWY	INITIAL CLIMB	ALTITUDE
15L/R	Unless otherwise assigned by ATC: Climb heading 147° to 1000. Continue climb heading 147° or as assigned. EXPECT RADAR vectors to OAKVL (or as assigned), then proceed via depicted route.	Unless otherwise assigned by ATC MAINTAIN 5000.
33L	Unless otherwise assigned by ATC: Climb heading 327° to 1100. Climbing RIGHT turn heading 345° or as assigned. EXPECT RADAR vectors to NUBAX (or as assigned), then proceed via depicted route.	
33R	Unless otherwise assigned by ATC: Climb heading 327° to 2100. Climbing RIGHT turn heading 340° or as assigned. EXPECT RADAR vectors to NUBAX (or as assigned), then proceed via depicted route.	

CYYZ/YYZ
LESTER B PEARSON INTL
28 APR 23
JEPPESSEN
(0-3B1)
TORONTO, ONT
RNAV SID

JEPPESEN
TORONTO, ONT
RNAV SID
 28 APR 23 (10-3B2)

Trans alt: 18000
 1. RADAR required.
 2. CAUTION: Rwy 05, 06L/R, 23, 24L/R departures: Simultaneous parallel departures in use. 3. Safe Altitude within 100 NM 4900. 4. Non-Jet aircraft only. 5. For use by GNS5 equipped aircraft. GNS5 aircraft with selectable CDI must be set to 1 NM sensitivity. Aircraft without selectable CDI must use flight director. 6. Refer to 10-4 Noise Abatement Procedures for additional requirements.

BOMET 8 DEPARTURE (BOMET8.)
(RWYS 05, 06L/R, 23, 24L/R)

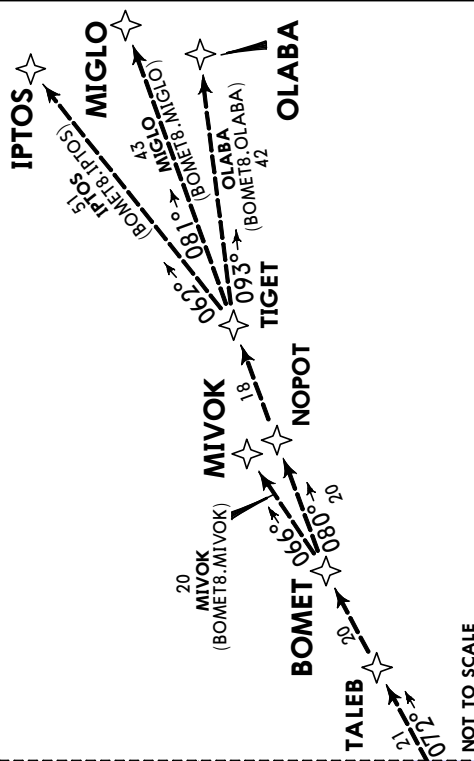

This SID requires minimum climb gradients of:

Rwy 05: 360 per NM to 2700.
 Rwy 06L: 400 per NM to 2700.
 Rwy 06R: 390 per NM to 2700.
 Rwy 24L: 270 per NM to 1700.
 Rwy 24R: 260 per NM to 1700.

Gnd speed-KT	75	100	150	200	250	300
260 per NM	325	433	650	867	1083	1300
270 per NM	338	450	675	900	1125	1350
360 per NM	450	600	900	1200	1500	1800
390 per NM	488	650	975	1300	1625	1950
400 per NM	500	667	1000	1333	1667	2000

RWY	INITIAL CLIMB	ALTITUDE
05	Unless otherwise assigned by ATC: Climb heading 057° to 1000. Climbing LEFT turn heading 047° or as assigned. EXPECT RADAR vectors to AVROS (or as assigned), then proceed via depicted route.	Unless otherwise assigned by ATC: MAINTAIN 3000. Aircraft assigned a turn at takeoff; commence turn at 1100
06L/R	Unless otherwise assigned by ATC: Climb heading 057° to 1000. Continue climb heading 057° or as assigned. EXPECT RADAR vectors to AVROS (or as assigned), then proceed via depicted route.	
23	Unless otherwise assigned by ATC: Climb heading 237° to 1100. Climbing RIGHT turn heading 245° or as assigned. EXPECT RADAR vectors to MAVAN (or as assigned), then proceed via depicted route.	
24L/R	Unless otherwise assigned by ATC: Climb heading 237° to 1000. Climbing LEFT turn heading 235° or as assigned. EXPECT RADAR vectors to MAVAN (or as assigned), then proceed via depicted route.	

CYYZ/YYZ
LESTER B PEARSON INTL

31
 LOST COMMS ▼ LOST COMMS ▼ LOST COMMS ▼ LOST COMMS ▼ LOST COMMS ▼ LOST
 On recognition of failure 20 minutes or less after take-off and in IFR weather conditions proceed as follows:
 1. Select transponder code 7600.
 2. Beyond 10 NM from CYYZ proceed directly on course.
 3. Do not climb above last assigned altitude for 5 minutes after recognition of failure.
 4. Climb to flight planned altitude.
 LOST COMMS ▲ LOST COMMS ▲ LOST COMMS ▲ LOST COMMS ▲ LOST COMMS ▲ LOST

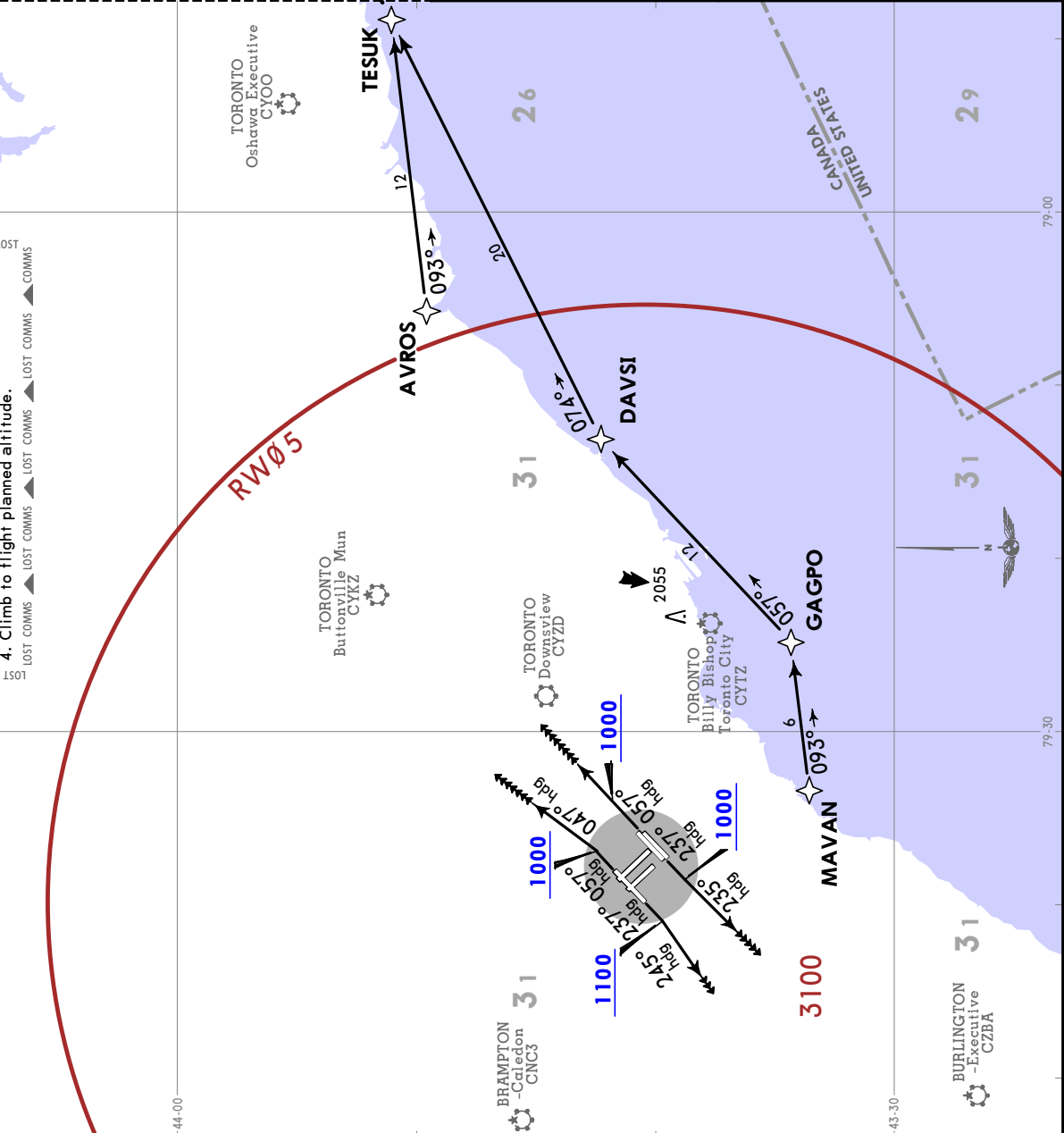

JEPPESEN
 28 APR 23 (10-3B3)
TORONTO, ONT
RNAV SID

CYYZ/YYZ
 LESTER B PEARSON INTL

TORONTO Departure
 128.8
 127.575

Apt Elev
 569

Trans alt: 18000
 1. RADAR required.
 2. Safe Altitude within 100 NM 4900.
 3. Non-Jet aircraft only.
 4. For use by GNSS equipped aircraft. GNSS aircraft with selectable CDI must be set to 1 NM sensitivity. Aircraft without selectable CDI must use flight director.
 5. Refer to 10-4 Noise Abatement Procedures for additional requirements.

BOMET 8 DEPARTURE (BOMET8.)
 (RWYS 15L/R, 33L/R)

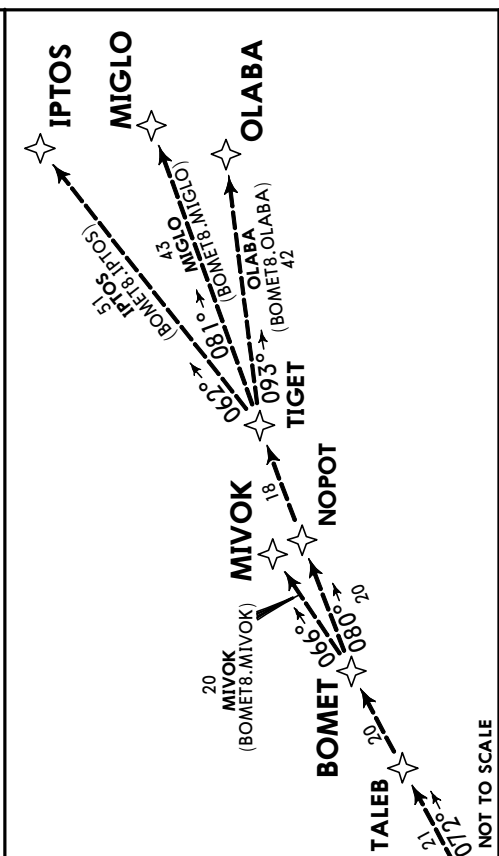

On recognition of failure 20 minutes or less after take-off and in IFR weather conditions proceed as follows:
 1. Select transponder code 7600.
 2. Beyond 10 NM from CYYZ proceed directly on course.
 3. Do not climb above last assigned altitude for 5 minutes after recognition of failure.
 4. Climb to flight planned altitude.

This SID requires minimum climb gradients of:
 Rwy 15L: 390 per NM to 3000.
 Rwy 15R: 380 per NM to 3000.
 Rwy 33L: 250 per NM to 900.

Grnd speed-KT	75	100	150	200	250	300
250 per NM	313	417	625	833	1042	1250
380 per NM	475	633	950	1267	1583	1900
390 per NM	488	650	975	1300	1625	1950

RWY	INITIAL CLIMB	ALTITUDE
15L/R	Unless otherwise assigned by ATC: Climb heading 147° to 1000. Continue climb heading 147° or as assigned. EXPECT RADAR vectors to DAVSI (or as assigned), then proceed via depicted route.	Unless otherwise assigned by ATC: MAINTAIN 3000. Aircraft assigned a turn at takeoff; commence turn at 1100
33L	Unless otherwise assigned by ATC: Climb heading 327° to 1100. Climbing RIGHT turn heading 345° or as assigned. EXPECT RADAR vectors to NUBAN (or as assigned), then proceed via depicted route.	
33R	Unless otherwise assigned by ATC: Climb heading 327° to 2100. Climbing RIGHT turn heading 340° or as assigned. EXPECT RADAR vectors to NUBAN (or as assigned), then proceed via depicted route.	

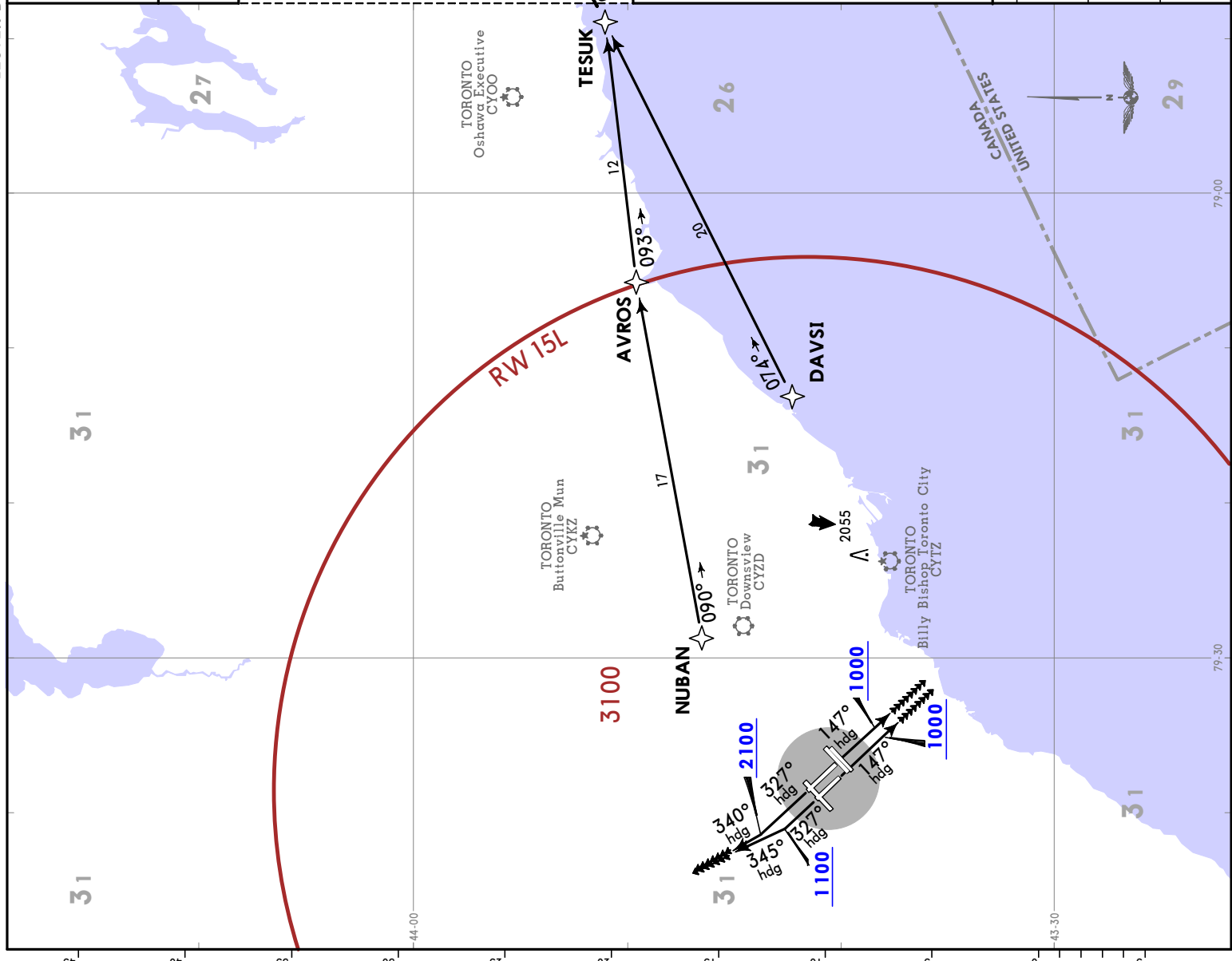

**JEYPESEN TORONTO, ONT
RNAV SID**

28 APR 23 (10-3C)

Trans alt: 18000
TORONTO
 Departure
128.8
127.575

Apt Elev
569

DEDKI 5 DEPARTURE (DEDKI5.)
(RWYS 05, 06L/R, 23, 24L/R)

1. RADAR required.
 2. CAUTION: Rwys 05, 06L/R, 23, 24L/R departures: Simultaneous parallel departures in use. 3. Safe Altitude within 100 NM 4900. 4. Jet aircraft only. 5. For use by GNS or D/D/I equipped aircraft. Aircraft with selectable CDI must be set to 1 NM sensitivity. Aircraft without selectable CDI must use flight director. 6. Refer to 10-4 Abatement Procedures for additional requirements.

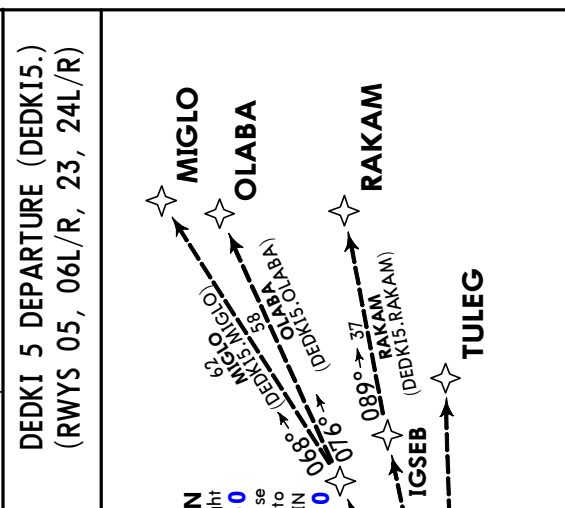

This SID requires minimum climb gradients of:

Rwy 05: 360 per NM to 2700.
 Rwy 06L: 400 per NM to 2700.
 Rwy 06R: 390 per NM to 2700.
 Rwy 24L: 270 per NM to 1700.
 Rwy 24R: 260 per NM to 1700.

Gnd speed-KT	75	100	150	200	250	300
260 per NM	325	433	650	867	1083	1300
270 per NM	338	450	675	900	1125	1350
360 per NM	450	600	900	1200	1500	1800
390 per NM	488	650	975	1300	1625	1950
400 per NM	500	667	1000	1333	1667	2000

RWY	INITIAL CLIMB	ALTITUDE
05	Unless otherwise assigned by ATC: Climb heading 057° to 1000. Climbing LEFT turn heading 047° or as assigned. EXPECT RADAR vectors to ALKUT (or as assigned), then proceed via depicted route.	
06L/R	Unless otherwise assigned by ATC: Climb heading 057° to 1000. Continue climb heading 057° or as assigned. EXPECT RADAR vectors to ALKUT (or as assigned), then proceed via depicted route.	
23	Unless otherwise assigned by ATC: Climb heading 237° to 1100. Climbing RIGHT turn heading 245° or as assigned. EXPECT RADAR vectors to SAVUR (or as assigned), then proceed via depicted route.	
24L/R	Unless otherwise assigned by ATC: Climb heading 237° to 1000. Climbing LEFT turn heading 235° or as assigned. EXPECT RADAR vectors to SAVUR (or as assigned), then proceed via depicted route.	

Unless otherwise assigned by ATC: MAINTAIN 5000

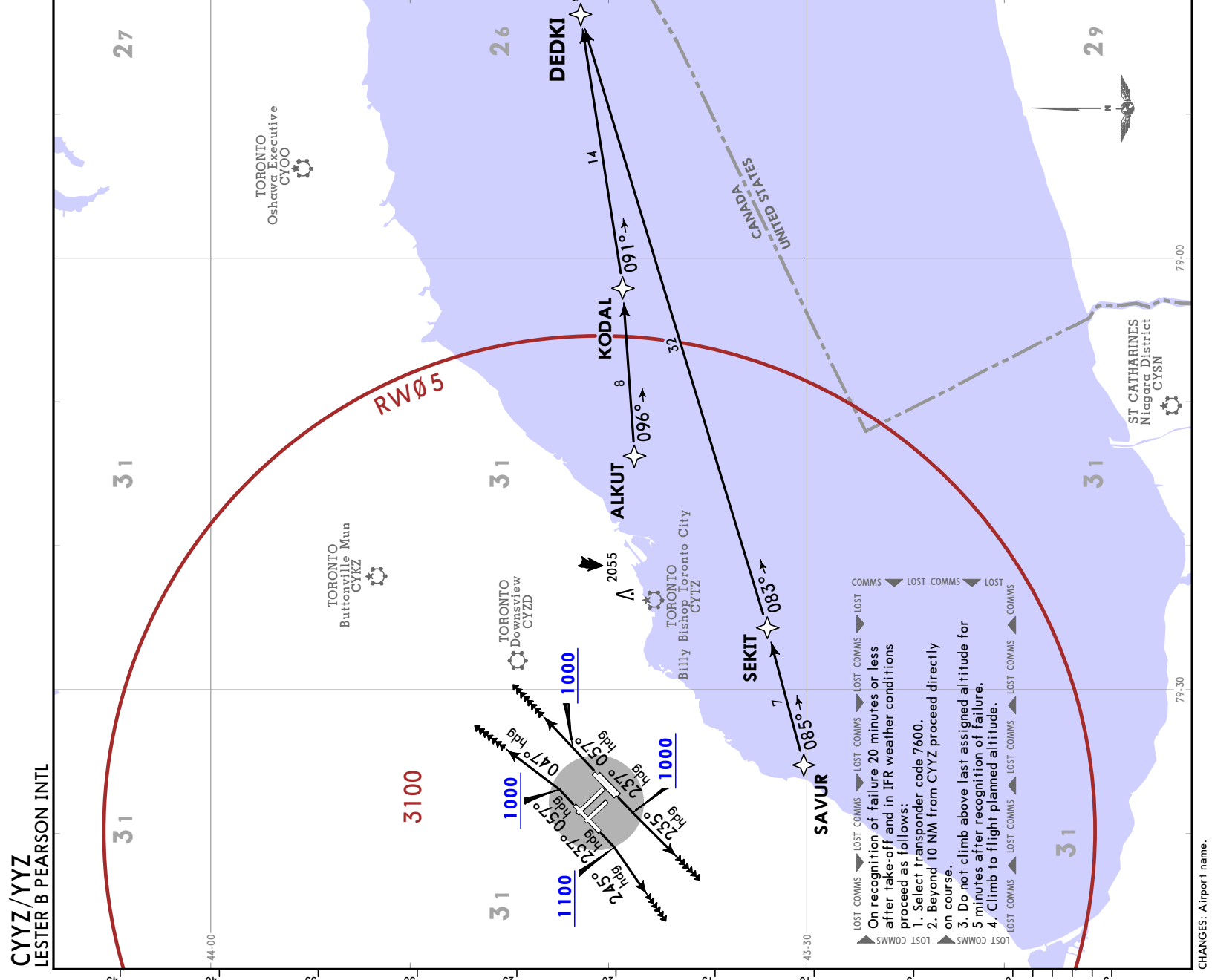

JEPPESEN
 TORONTO, ONT
 RNAV SID

CYYZ/YYZ
 LESTER B PEARSON INTL

28 APR 23 (10-3CI)

TORONTO
 Departure
 128.8
 127.575

Apt Elev
 569

Trans alt: 18000
 1. RADAR required.
 2. Safe Altitude within 100 NM 4900.
 3. Jet aircraft only.
 4. For use by GNSS or D/D/I equipped aircraft.
 Aircraft with selectable CDI must be set to 1 NM sensitivity. Aircraft without selectable CDI must use flight director.
 5. Refer to 10-4 Noise Abatement Procedures for additional requirements.

DEDKI 5 DEPARTURE (DEDKI5.)
 (RWYS 15L/R, 33L/R)

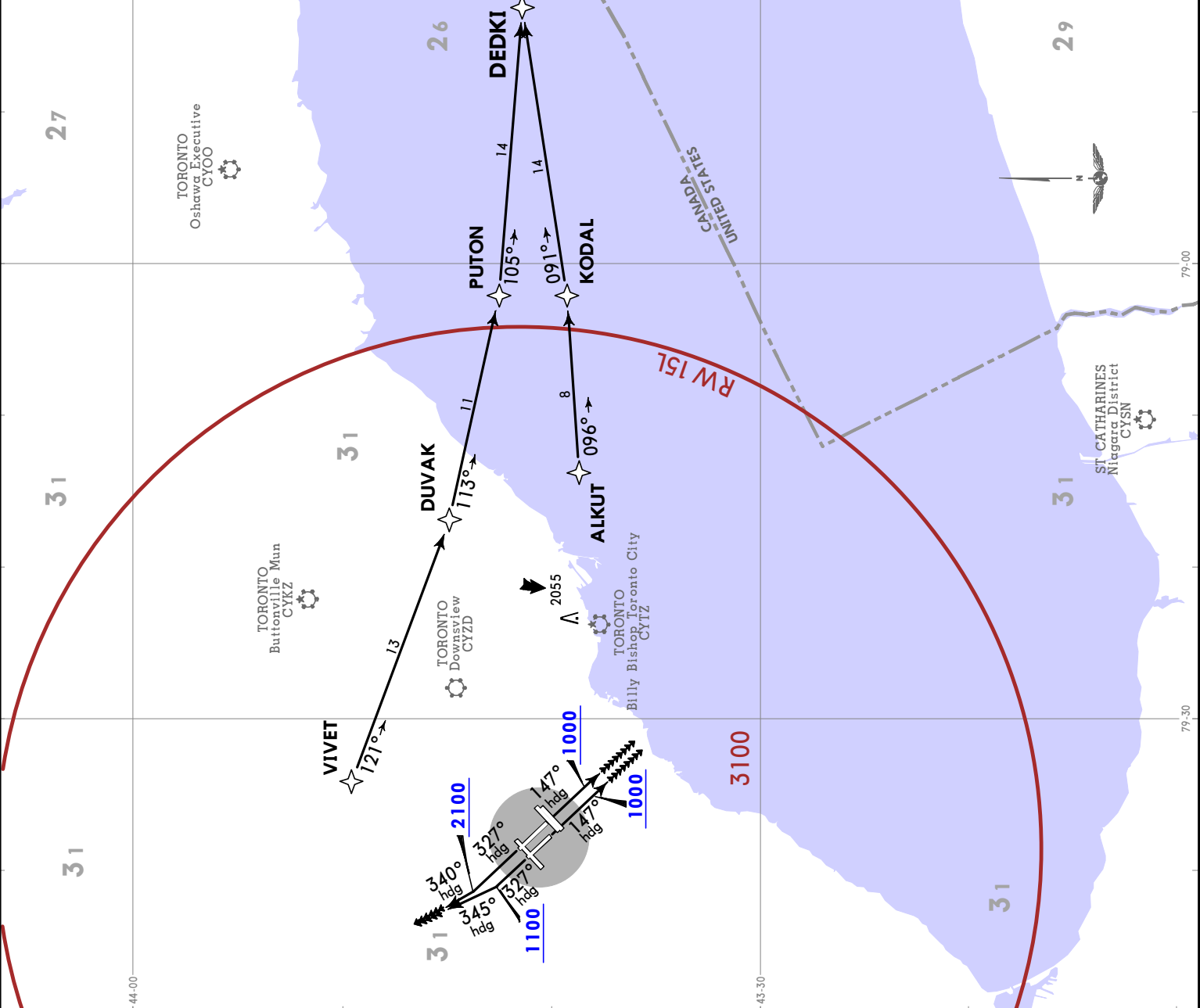

RWY	INITIAL CLIMB	ALTITUDE
15L/R	Unless otherwise assigned by ATC: Climb heading 147° to 1000. Continue climb heading 147° or as assigned. EXPECT RADAR vectors to ALKUT (or as assigned), then proceed via depicted route.	Unless otherwise assigned by ATC MAINTAIN 5000
33L	Unless otherwise assigned by ATC: Climb heading 327° to 1100. Climbing RIGHT turn heading 345° or as assigned. EXPECT RADAR vectors to VIVET (or as assigned), then proceed via depicted route.	
33R	Unless otherwise assigned by ATC: Climb heading 327° to 2100. Climbing RIGHT turn heading 340° or as assigned. EXPECT RADAR vectors to VIVET (or as assigned), then proceed via depicted route.	

CHANGES: Airport name.

CYYZ/YYZ
LESTER B PEARSON INTL

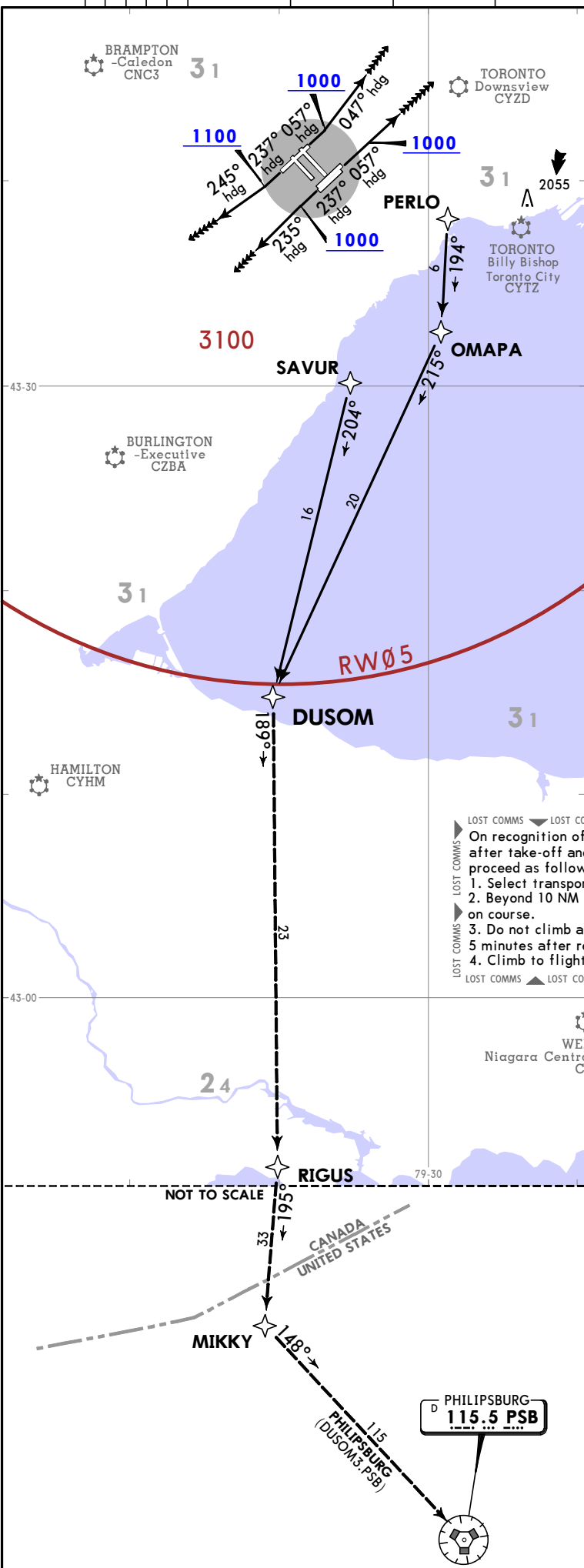

TORONTO Departure 128.8 127.575	Apt Elev 569	Trans alt: 18000 1. RADAR required. 2. CAUTION: Rwy 05, 06L/R, 23, 24L/R departures: Simultaneous parallel departures in use. 3. Safe Altitude within 100 NM 4900. 4. Non-Jet aircraft only. 5. For use by GNSS equipped aircraft. GNSS aircraft with selectable CDI must be set to 1 NM sensitivity. Aircraft without selectable CDI must use flight director. 6. Refer to 10-4 Noise Abatement Procedures for additional requirements.
--	-----------------	--

DUSOM 3 DEPARTURE (DUSOM3.) (RWYS 05, 06L/R, 23, 24L/R)

This SID requires minimum climb gradients of:
 Rwy 05: 360 per NM to 2700.
 Rwy 06L: 400 per NM to 2700.
 Rwy 06R: 390 per NM to 2700.
 Rwy 24L: 270 per NM to 1700.
 Rwy 24R: 260 per NM to 1700.

Gnd speed-KT	75	100	150	200	250	300
260 per NM	325	433	650	867	1083	1300
270 per NM	338	450	675	900	1125	1350
360 per NM	450	600	900	1200	1500	1800
390 per NM	488	650	975	1300	1625	1950
400 per NM	500	667	1000	1333	1667	2000

RWY	INITIAL CLIMB	ALTITUDE
05	Unless otherwise assigned by ATC: Climb heading 057° to 1000. Climbing LEFT turn heading 047° or as assigned. EXPECT RADAR vectors to PERLO (or as assigned), then proceed via depicted route.	Unless otherwise assigned by ATC: MAINTAIN 3000 Aircraft assigned a turn at takeoff commence turn at 1100.
06L/R	Unless otherwise assigned by ATC: Climb heading 057° to 1000. Continue climb heading 057° or as assigned. EXPECT RADAR vectors to PERLO (or as assigned), then proceed via depicted route.	
23	Unless otherwise assigned by ATC: Climb heading 237° to 1100. Climbing RIGHT turn heading 245° or as assigned. EXPECT RADAR vectors to SAVUR (or as assigned), then proceed via depicted route.	
24L/R	Unless otherwise assigned by ATC: Climb heading 237° to 1000. Climbing LEFT turn heading 235° or as assigned. EXPECT RADAR vectors to SAVUR (or as assigned), then proceed via depicted route.	

LOST COMMS
 On recognition of failure 20 minutes or less after take-off and in IFR weather conditions proceed as follows:
 1. Select transponder code 7600.
 2. Beyond 10 NM from CYYZ proceed directly on course.
 3. Do not climb above last assigned altitude for 5 minutes after recognition of failure.
 4. Climb to flight planned altitude.

DUSOM 3 DEPARTURE (DUSOM3.)
(RWYS 05, 06L/R, 23, 24L/R)

28 APR 23 (10-3C2)
JEPPesen TORONTO, ONT
RNAV SID

CHANGES: Airport name.

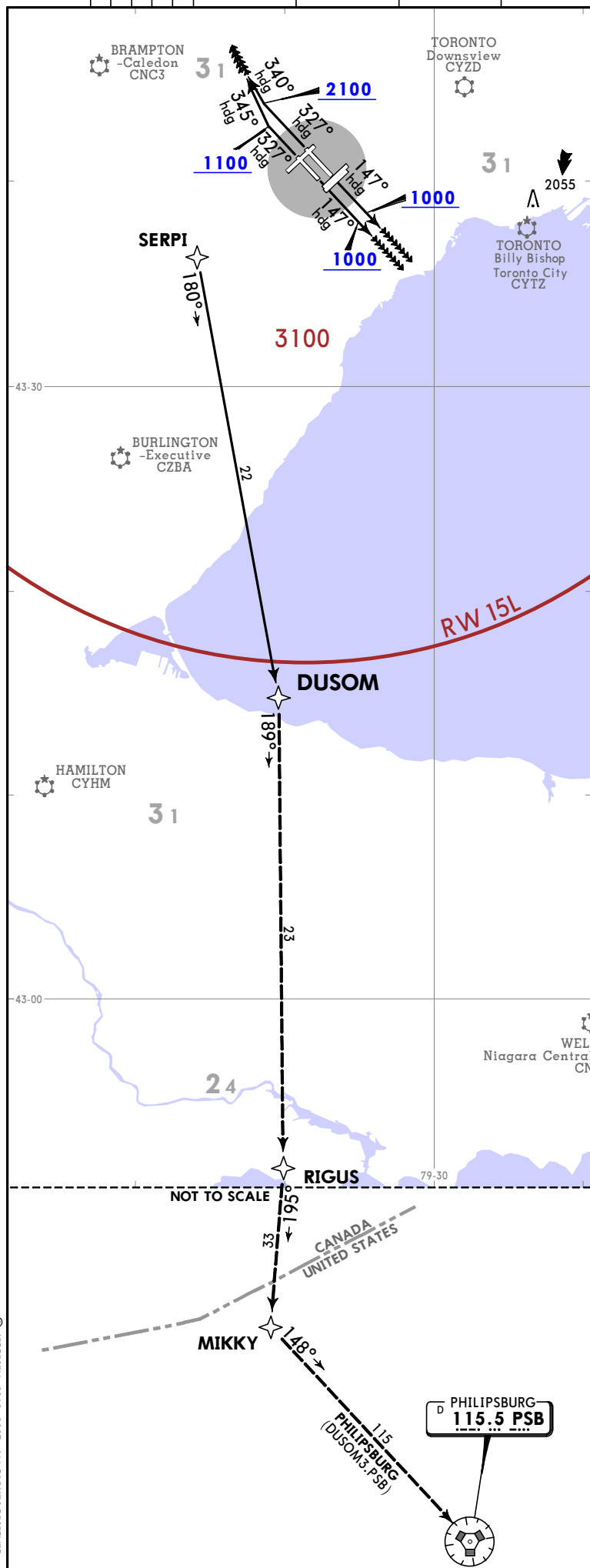

TORONTO Departure 128.8 127.575	Apt Elev 569	Trans alt: 18000 1. RADAR required. 2. Safe Altitude within 100 NM 4900. 3. Non-Jet aircraft only. 4. For use by GNSS equipped aircraft. GNSS aircraft with selectable CDI must be set to 1 NM sensitivity. Aircraft without selectable CDI must use flight director. 5. Refer to 10-4 Noise Abatement Procedures for additional requirements.
--	-----------------	---

DUSOM 3 DEPARTURE (DUSOM3.) (RWYS 15L/R, 33L/R)

LOST COMMS ◀ LOST COMMS ▶ LOST COMMS ◀ LOST COMMS ▶ LOST COMMS ◀ LOST COMMS ▶ LOST COMMS ◀ LOST COMMS ▶ LOST COMMS

On recognition of failure 20 minutes or less after take-off and in IFR weather conditions proceed as follows:

1. Select transponder code 7600.
2. Beyond 10 NM from CYYZ proceed directly on course.
3. Do not climb above last assigned altitude for 5 minutes after recognition of failure.
4. Climb to flight planned altitude.

LOST COMMS ◀ LOST COMMS ▶ LOST COMMS ◀ LOST COMMS ▶ LOST COMMS ◀ LOST COMMS ▶ LOST COMMS ◀ LOST COMMS ▶ LOST COMMS

This SID requires minimum climb gradients of:

Rwy 15L:	390 per NM to 3000.					
Rwy 15R:	380 per NM to 3000.					
Rwy 33L:	250 per NM to 900.					

Gnd speed-KT	75	100	150	200	250	300
250 per NM	313	417	625	833	1042	1250
380 per NM	475	633	950	1267	1583	1900
390 per NM	488	650	975	1300	1625	1950

RWY	INITIAL CLIMB	ALTITUDE
15L/R	Unless otherwise assigned by ATC: Climb heading 147° to 1000. Continue climb heading 147° or as assigned. EXPECT RADAR vectors to DUSOM (or as assigned), then proceed via depicted route.	Unless otherwise assigned by ATC: MAINTAIN 3000 Aircraft assigned a turn at takeoff; commence turn at 1100.
33L	Unless otherwise assigned by ATC: Climb heading 327° to 1100. Climbing RIGHT turn heading 345° or as assigned. EXPECT RADAR vectors to SERPI (or as assigned), then proceed via depicted route.	
33R	Unless otherwise assigned by ATC: Climb heading 327° to 2100. Climbing RIGHT turn heading 340° or as assigned. EXPECT RADAR vectors to SERPI (or as assigned), then proceed via depicted route.	

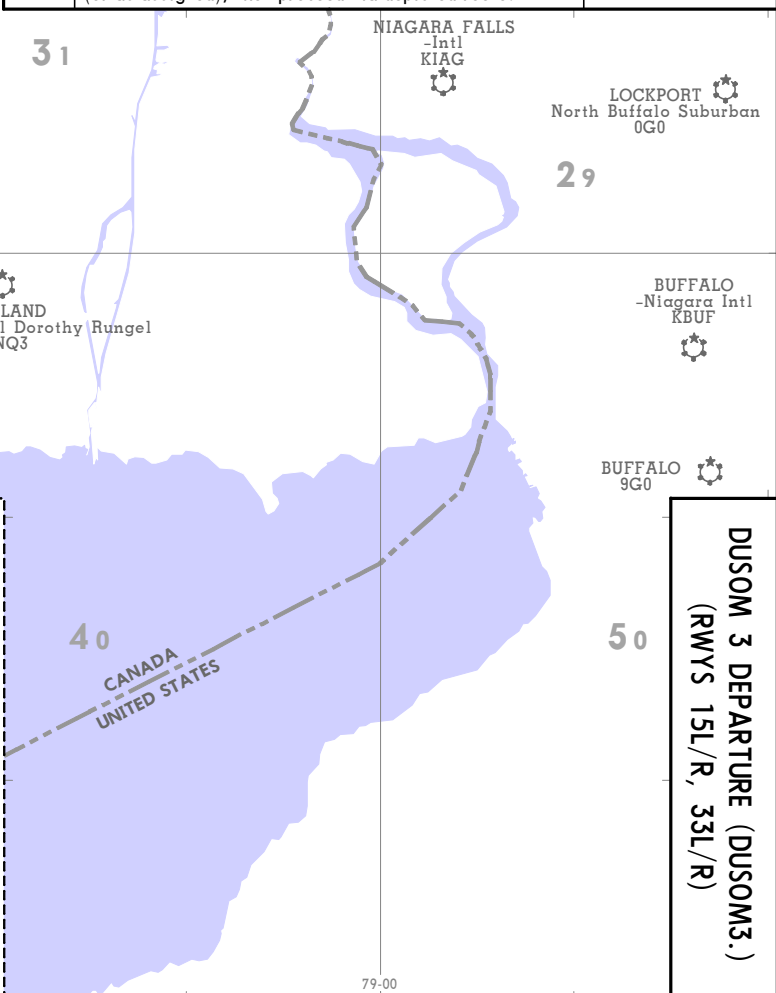

CYYZ/YYZ
LESTER B PEARSON INTL

28 APR 23
JEPPESSEN
10-3033

TORONTO, ONT
RNAV SID

DUSOM 3 DEPARTURE (DUSOM3.) (RWYS 15L/R, 33L/R)

EBKIN 4 DEPARTURE (EBKIN4.)
(RWYS 05, 06L/R, 23, 24L/R)

Traps alt: 18000

- RADAR required.
- CAUTION: Rwy 05, 06L/R, 23, 24L/R departures: Simultaneous parallel departures in use.
- Safe Altitude within 100 NM 4900.
- Non-Jet aircraft only.
- For use by GNSS equipped aircraft. GNSS aircraft with selectable CDI must be set to 1 NM sensitivity. Aircraft without selectable CDI must use flight director.
- Refer to 10-4 Noise Abatement Procedures for additional requirements.

TORONTO Departure
128.8 127.575

Apt Elev
569

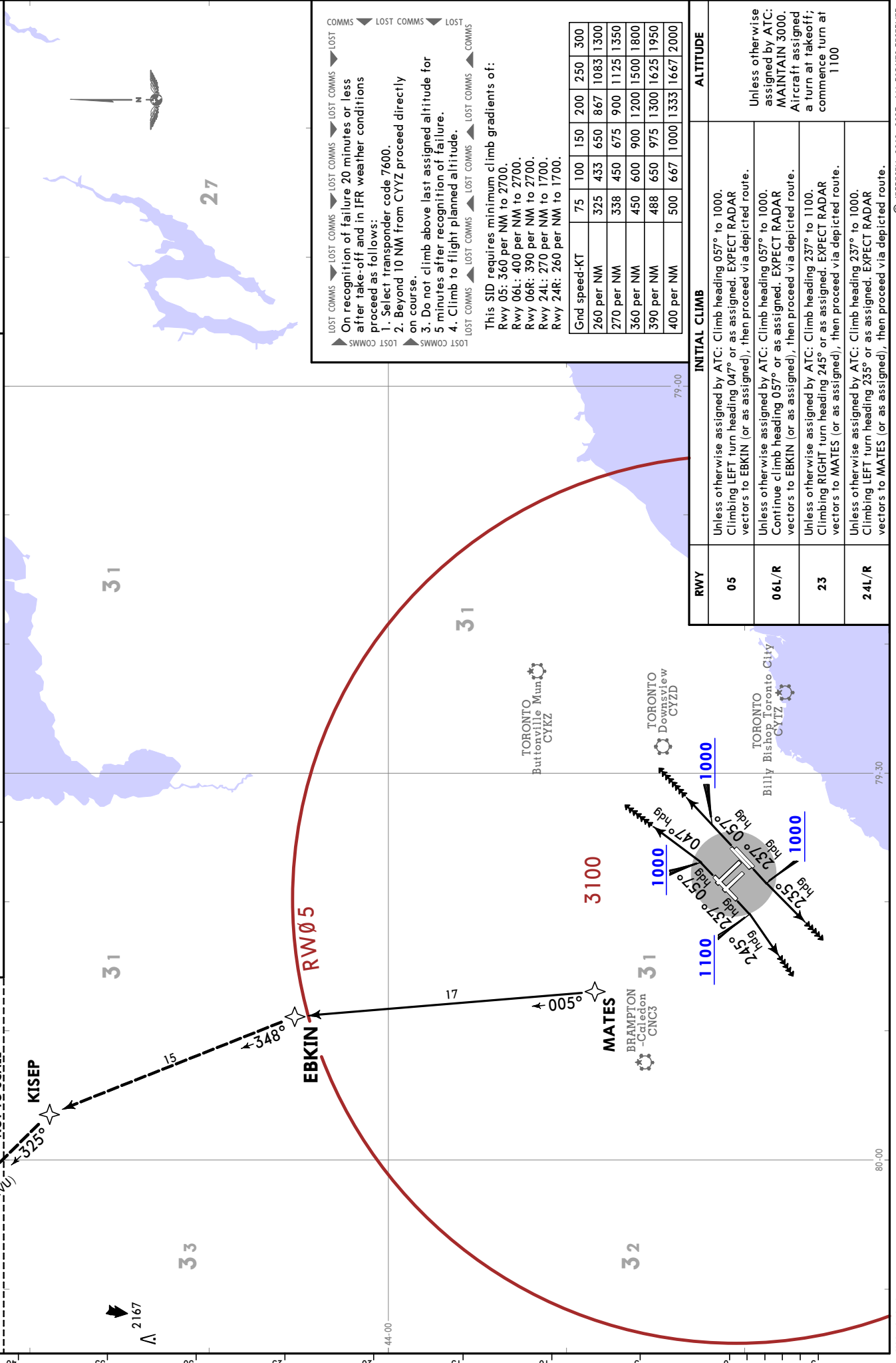

TORONTO, ONT
RNAV SID

JEPPESSEN
 28 APR 23 (10-3D)

CYYZ/YYZ
 LESTER B PEARSON INTL

TORONTO Departure
 128.8
 127.575

Apt Elev
 569

Trans alt: 18000

1. RADAR required.
2. Safe Altitude within 100 NM 4900.
3. Non-Jet aircraft only.
4. For use by GNS equipped aircraft. GNSS aircraft with selectable CDI must be set to 1 NM sensitivity. Aircraft without selectable CDI must use flight director.
5. Refer to 10-4 Noise Abatement Procedures for additional requirements.

EBKIN 4 DEPARTURE (EBKIN4.)
(RWYS 15L/R, 33L/R)

This SID requires minimum climb gradients of:

Rwy 15L: 390 per NM to 3000.
 Rwy 15R: 380 per NM to 3000.
 Rwy 33L: 250 per NM to 900.

Gnd speed-KT	75	100	150	200	250	300
250 per NM	313	417	625	833	1042	1250
380 per NM	475	633	950	1267	1583	1900
390 per NM	488	650	975	1300	1625	1950

On recognition of failure 20 minutes or less after take-off and in IFR weather conditions proceed as follows:
 1. Select transponder code 7600.
 2. Beyond 10 NM from CYYZ proceed directly on course.
 3. Do not climb above last assigned altitude for 5 minutes after recognition of failure.
 4. Climb to flight planned altitude.

RWY	INITIAL CLIMB	ALTITUDE
15L/R	Unless otherwise assigned by ATC: Climb heading 147° to 1000. Continue climb heading 147° or as assigned. EXPECT RADAR vectors to ETLER (or as assigned), then proceed via depicted route.	Unless otherwise assigned by ATC: MAINTAIN 3000 Aircraft assigned a turn at takeoff; commence turn at 1100.
33L	Unless otherwise assigned by ATC: Climb heading 327° to 1100. Climbing RIGHT turn heading 345° or as assigned. EXPECT RADAR vectors to EBKIN (or as assigned), then proceed via depicted route.	
33R	Unless otherwise assigned by ATC: Climb heading 327° to 2100. Climbing RIGHT turn heading 340° or as assigned. EXPECT RADAR vectors to EBKIN (or as assigned), then proceed via depicted route.	

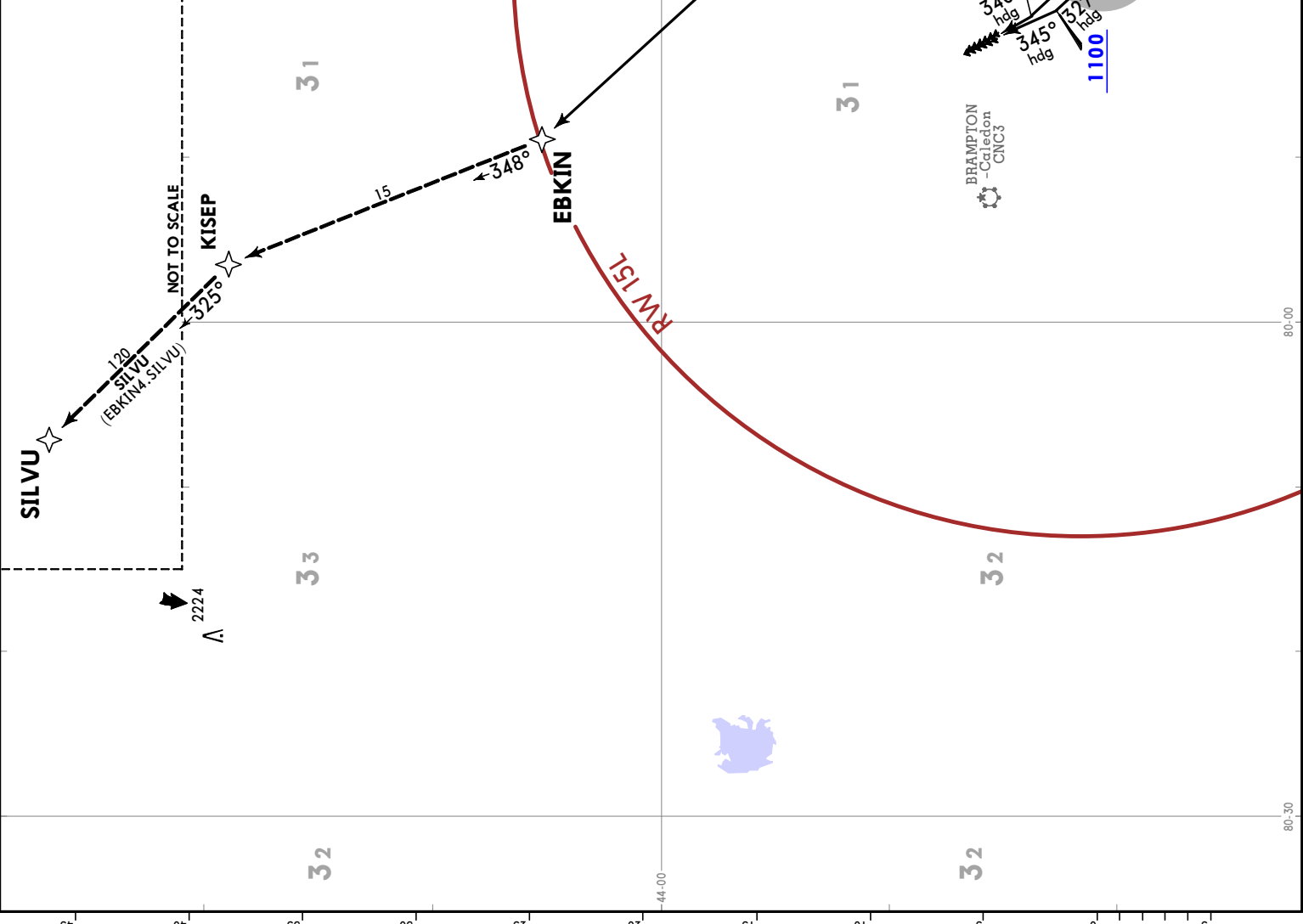

GOPUP 4 DEPARTURE (GOPUP4.)
(RWYS 05, 06L/R, 23, 24L/R)

Trans alt: 18000
 1. RADAR required
 2. CAUTION: Rwy 05, 06L/R, 23, 24L/R departures: Simultaneous parallel departures in use.
 3. Safe Altitude within 100 NM 4900.

4. Jet aircraft only.
 5. For use by GNSS or D/D/I equipped aircraft. Aircraft with selectable CDI must be set to 1 NM sensitivity. Aircraft without selectable CDI must use flight director.
 6. Refer to 10-4 Noise Abatement Procedures for additional requirements.

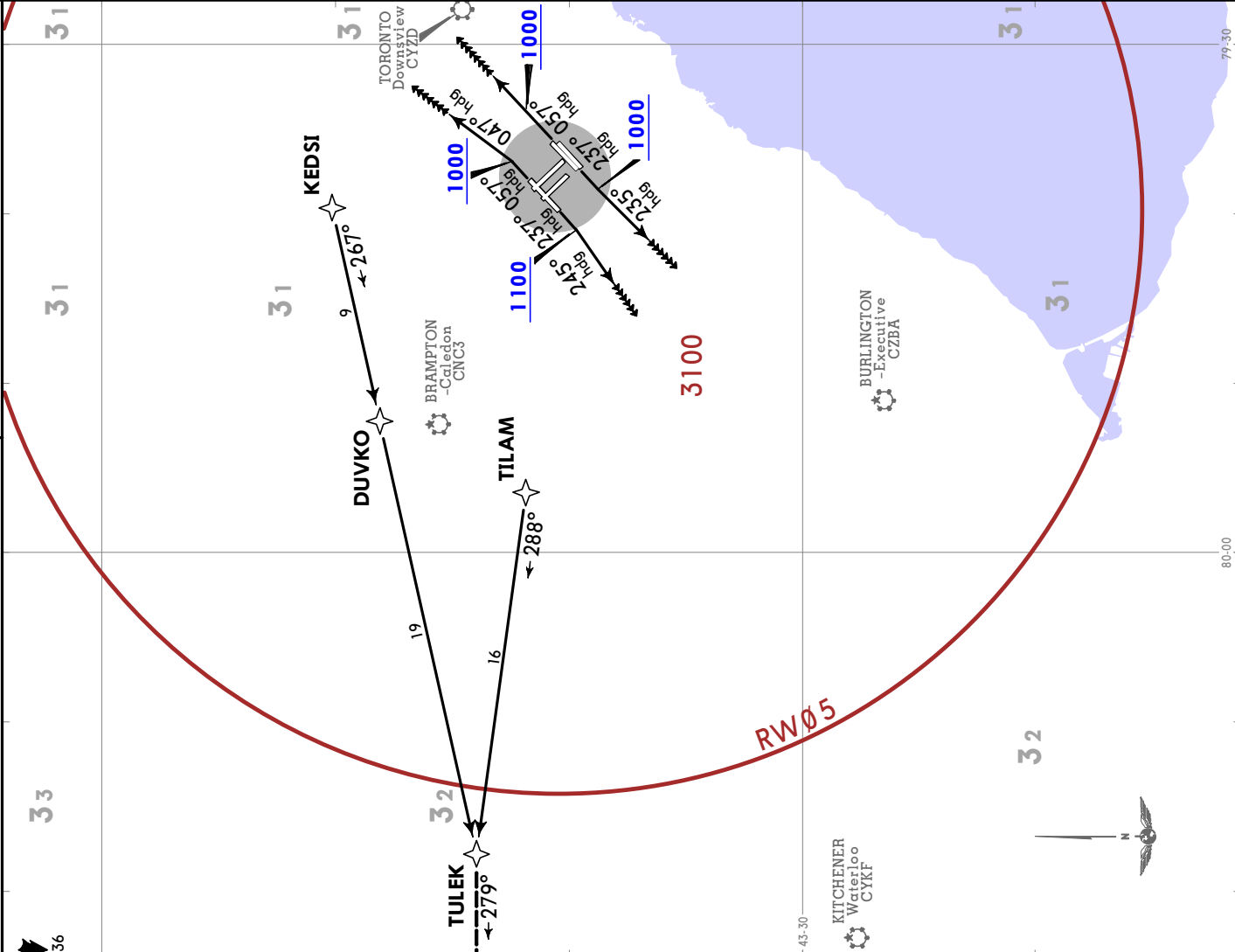

RWY	INITIAL CLIMB								ALTITUDE
	75	100	150	200	250	300	350	400	
05	325	433	650	867	1083	1300	1517	1733	Unless otherwise assigned by ATC: Climb heading 057° to 1000. Climbing LEFT turn heading 047° or as assigned. EXPECT RADAR vectors to KEDSI (or as assigned), then proceed via depicted route.
06L/R	338	450	675	900	1125	1350	1575	1800	Unless otherwise assigned by ATC: Climb heading 057° to 1000. Continue climb heading 057° or as assigned. EXPECT RADAR vectors to KEDSI (or as assigned), then proceed via depicted route.
23	450	600	900	1200	1500	1800	2100	2400	Unless otherwise assigned by ATC: Climb heading 237° to 1100. Climbing RIGHT turn heading 245° or as assigned. EXPECT RADAR vectors to TILAM (or as assigned), then proceed via depicted route.
24L/R	488	650	975	1300	1625	1950	2275	2600	Unless otherwise assigned by ATC: Climb heading 237° to 1000. Climbing LEFT turn heading 235° or as assigned. EXPECT RADAR vectors to TILAM (or as assigned), then proceed via depicted route.

CYYZ/YYZ
LESTER B PEARSON INTL
28 APR 23
(10-3D3)
JEPPESSEN
TORONTO, ONT
RNAV SID

Trans alt: 18000
1. RADAR required.
2. Safe Altitude within 100 NM 4900.
3. Jet aircraft only.
4. For use by GNS or D/D/1 equipped aircraft. Aircraft with selectable CDI must be set to 1 NM sensitivity. Aircraft without selectable CDI must use flight director.
5. Refer to 10-4 Noise Abatement Procedures for additional requirements.

TORONTO Departure
128.8
127.575

Apt Elev
569

GOPUP 4 DEPARTURE (GOPUP4.)
(RWYS 15L/R, 33L/R)

This SID requires minimum climb gradients of:

Rwy 15L: 390 per NM to 3000.
Rwy 15R: 380 per NM to 3000.
Rwy 33L: 250 per NM to 900.

Gnd speed-KT	75	100	150	200	250	300
250 per NM	313	417	625	833	1042	1250
380 per NM	475	633	950	1267	1583	1900
390 per NM	488	650	975	1300	1625	1950

On recognition of failure 20 minutes or less after take-off and in IFR weather conditions proceed as follows:
1. Select transponder code 7600.
2. Beyond 10 NM from CYYZ proceed directly on course.
3. Do not climb above last assigned altitude for 5 minutes after recognition of failure.
4. Climb to flight planned altitude.

RWY	INITIAL CLIMB	ALTITUDE
15L/R	Unless otherwise assigned by ATC: Climb heading 147° to 1000. Continue climb heading 147° or as assigned. EXPECT RADAR vectors to BOVAL (or as assigned), then proceed via depicted route.	Unless otherwise assigned by ATC: MAINTAIN 5000.
33L	Unless otherwise assigned by ATC: Climb heading 327° to 1100. Climbing RIGHT turn heading 345° or as assigned. EXPECT RADAR vectors to TETAD (or as assigned), then proceed via depicted route.	
33R	Unless otherwise assigned by ATC: Climb heading 327° to 2100. Climbing RIGHT turn heading 340° or as assigned. EXPECT RADAR vectors to TETAD (or as assigned), then proceed via depicted route.	

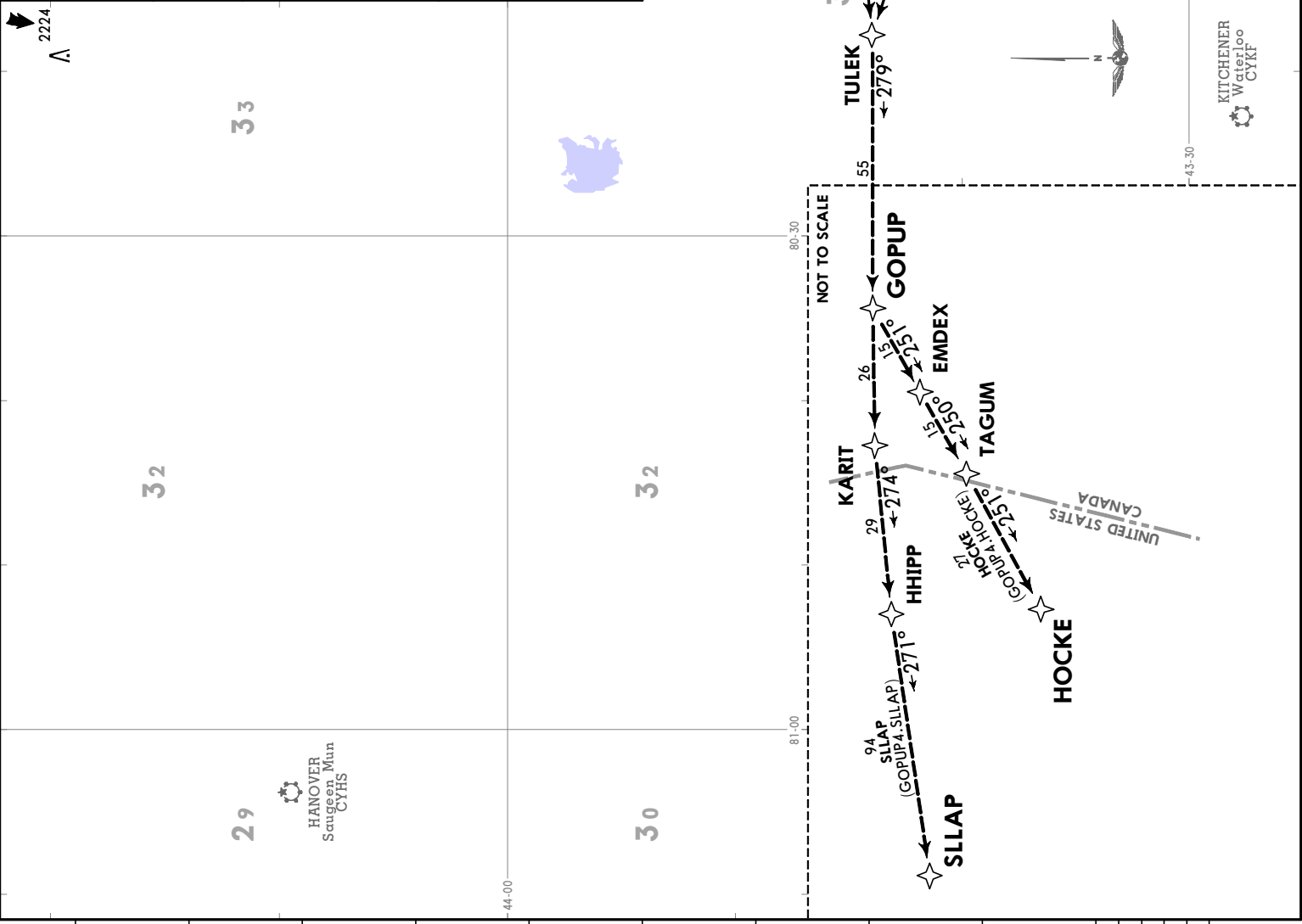

Trans alt: 18000
1. RADAR required.
2. CAUTION: Rwy 05, 06L/R, 23, 24L/R departures: Simultaneous parallel departures in use.
3. Safe Altitude within 100 NM 4900.

4. Jet aircraft only.
5. For use by GNSS or D/D/I equipped aircraft. Aircraft with selectable CDI must be set to 1 NM sensitivity. Aircraft without selectable CDI must use flight director.
6. Refer to 10-4 Noise Abatement Procedures for additional requirements.

A 2167

On recognition of failure 20 minutes or less after take-off and in IFR weather conditions proceed as follows:
1. Select transponder code 7600.
2. Beyond 10 NM from CYYZ proceed directly on course.
3. Do not climb above last assigned altitude for 5 minutes after recognition of failure.
4. Climb to flight planned altitude.

This SID requires minimum climb gradients of:
Rwy 05: 360 per NM to 2700.
Rwy 06L: 400 per NM to 2700.
Rwy 06R: 390 per NM to 2700.
Rwy 24L: 270 per NM to 1700.
Rwy 24R: 260 per NM to 1700.

Gnd speed-KT	75	100	150	200	250	300
260 per NM	325	433	650	867	1083	1300
270 per NM	338	450	675	900	1125	1350
360 per NM	450	600	900	1200	1500	1800
390 per NM	488	650	975	1300	1625	1950
400 per NM	500	667	1000	1333	1667	2000

RWY	INITIAL CLIMB	ALTITUDE
05	Unless otherwise assigned by ATC: Climb heading 057° to 1000. Climbing LEFT turn heading 047° or as assigned. EXPECT RADAR vectors to GOTIM (or as assigned), then proceed via depicted route.	Unless otherwise assigned by ATC: MAINTAIN 5000
06L/R	Unless otherwise assigned by ATC: Climb heading 057° to 1000. Continue climb heading 057° or as assigned. EXPECT RADAR vectors to GOTIM (or as assigned), then proceed via depicted route.	
23	Unless otherwise assigned by ATC: Climb heading 237° to 1100. Climbing RIGHT turn heading 245° or as assigned. EXPECT RADAR vectors to BISTI (or as assigned), then proceed via depicted route.	
24L/R	Unless otherwise assigned by ATC: Climb heading 237° to 1000. Climbing LEFT turn heading 235° or as assigned. EXPECT RADAR vectors to BISTI (or as assigned), then proceed via depicted route.	

44-00

80-30

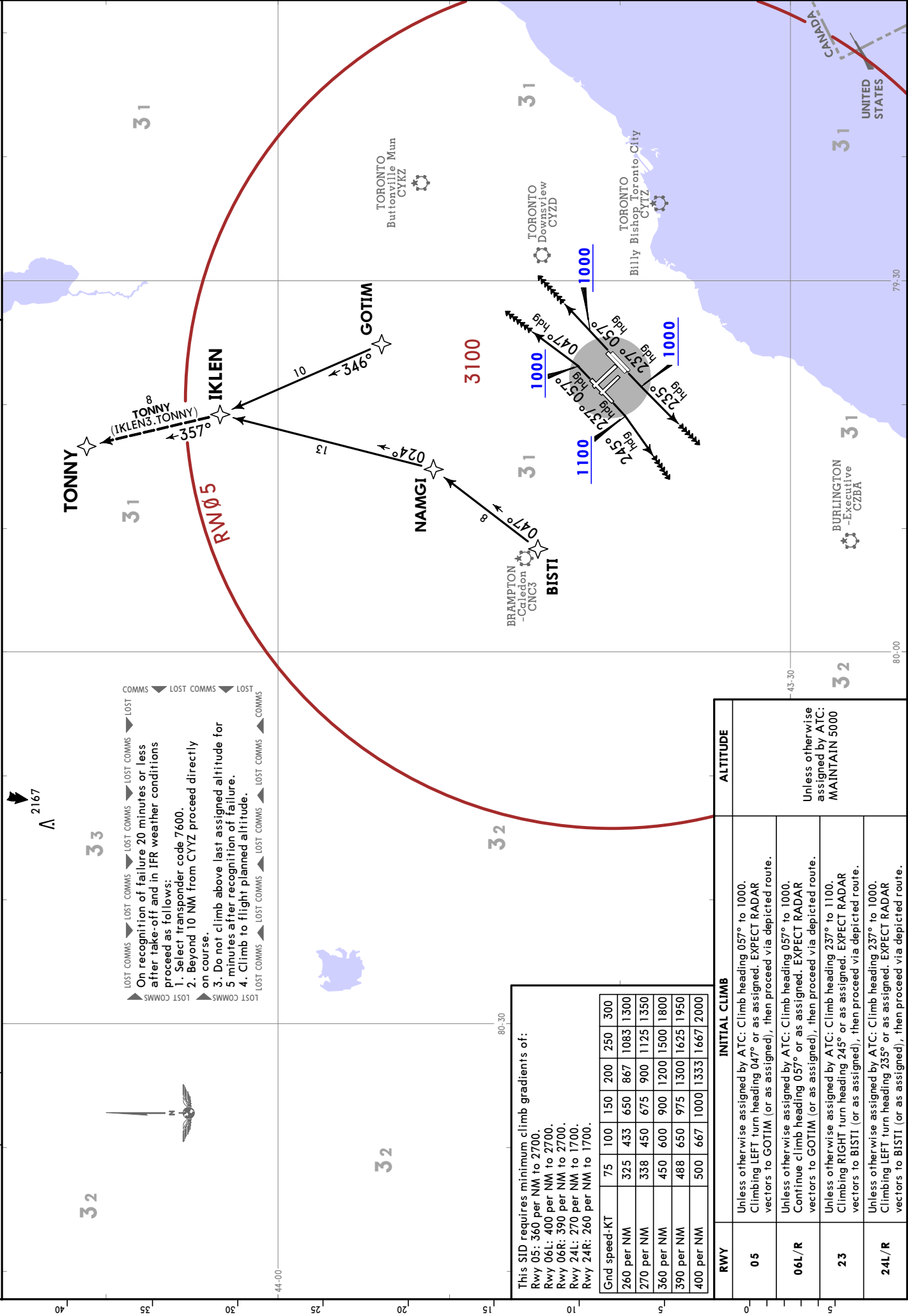

JEPPESSEN
CYYZ/YYZ
LESTER B PEARSON INTL
 28 APR 23
(10-3E1)
RNAV SID
TORONTO, ONT

Trans alt: 18000
 1. RADAR required.
 2. Safe Altitude within 100 NM 4900.
 3. Jet aircraft only.
 4. For use by GNS or D/D/1 equipped aircraft. Aircraft with selectable CDI must be set to 1 NM sensitivity. Aircraft without selectable CDI must use flight director.
 5. Refer to 10-4 Noise Abatement Procedures for additional requirements.

TORONTO
 Departure
128.8
127.575

Apt Elev
569

IKLEN 3 DEPARTURE (IKLEN3.)
(RWYS 15L/R, 33L/R)

This SID requires minimum climb gradients of:
 Rwy 15L: 390 per NM to 3000.
 Rwy 15R: 380 per NM to 3000.
 Rwy 33L: 250 per NM to 900.

Gnd speed-KT	75	100	150	200	250	300
250 per NM	313	417	625	833	1042	1250
380 per NM	475	633	950	1267	1583	1900
390 per NM	488	650	975	1300	1625	1950

LOST COMMS
 On recognition of failure 20 minutes or less after take-off and in IFR weather conditions proceed as follows:
 1. Select transponder code 7600.
 2. Beyond 10 NM from CYYZ proceed directly on course.
 3. Do not climb above last assigned altitude for 5 minutes after recognition of failure.
 4. Climb to flight planned altitude.

RWY	INITIAL CLIMB	ALTITUDE
15L/R	Unless otherwise assigned by ATC: Climb heading 147° to 1000. Continue climb heading 147° or as assigned. EXPECT RADAR vectors to BORUX (or as assigned), then proceed via depicted route.	
33L	Unless otherwise assigned by ATC: Climb heading 327° to 1100. Climbing RIGHT turn heading 345° or as assigned. EXPECT RADAR vectors to IKLEN (or as assigned), then proceed via depicted route.	Unless otherwise assigned by ATC: MAINTAIN 5000.
33R	Unless otherwise assigned by ATC: Climb heading 327° to 2100. Climbing RIGHT turn heading 340° or as assigned. EXPECT RADAR vectors to IKLEN (or as assigned), then proceed via depicted route.	

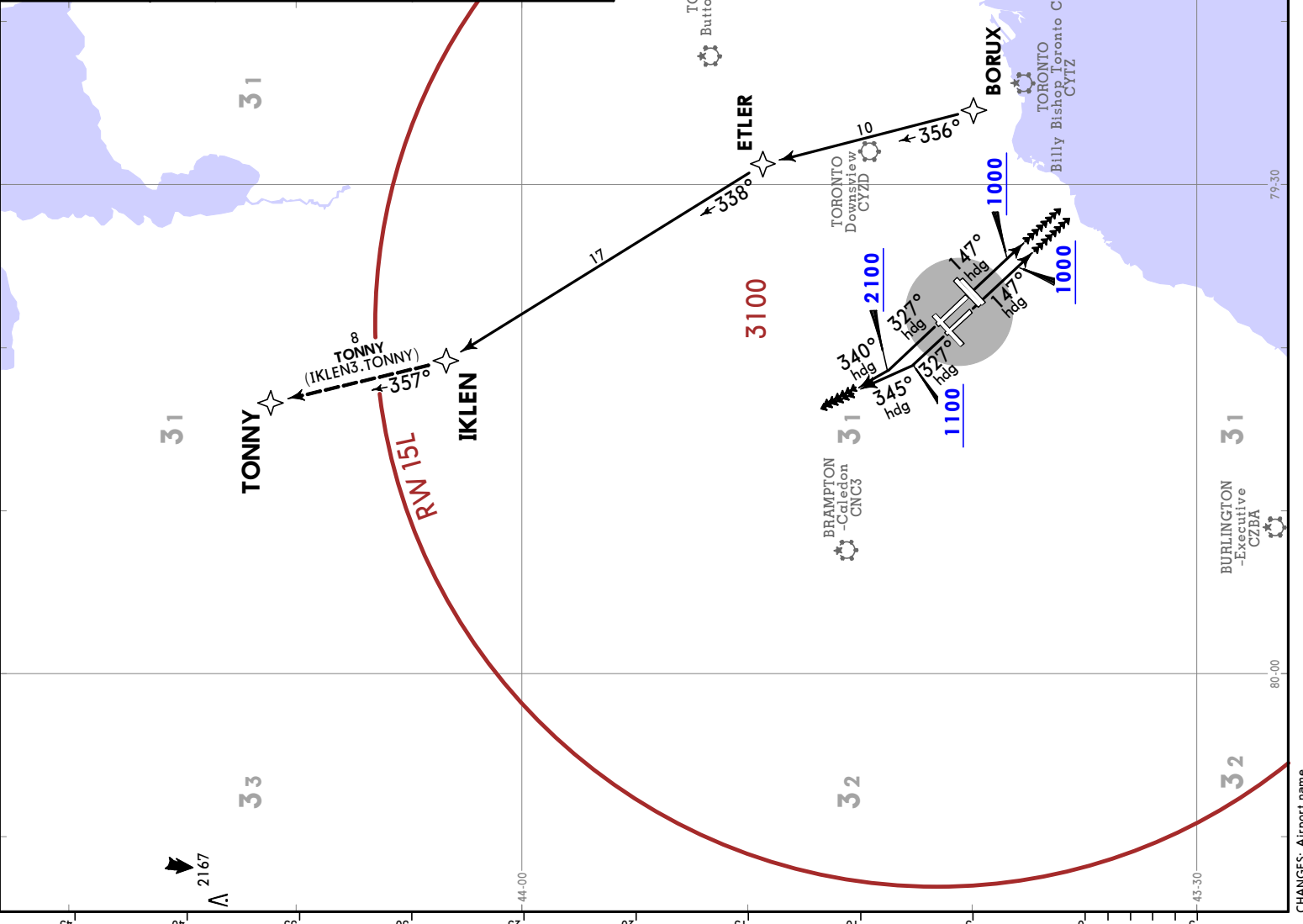

TORONTO Departure
 128.8 127.575

Apt Elev
 569

Trans alt: 18000
 1. RADAR required.
 2. CAUTION: Rwy 05, 06L/R, 23, 24L/R departures: Simultaneous parallel departures in use.
 3. Safe Altitude within 100 NM 4900.

4. Jet aircraft only.
 5. For use by GNSS or D/D/I equipped aircraft. Aircraft with selectable CDI must be set to 1 NM sensitivity. Aircraft without selectable CDI must use flight director.
 6. Refer to 10-4 Noise Abatement Procedures for additional requirements.

KEPTA 3 DEPARTURE (KEPTA3.)
 (RWYS 05, 06L/R, 23, 24L/R)

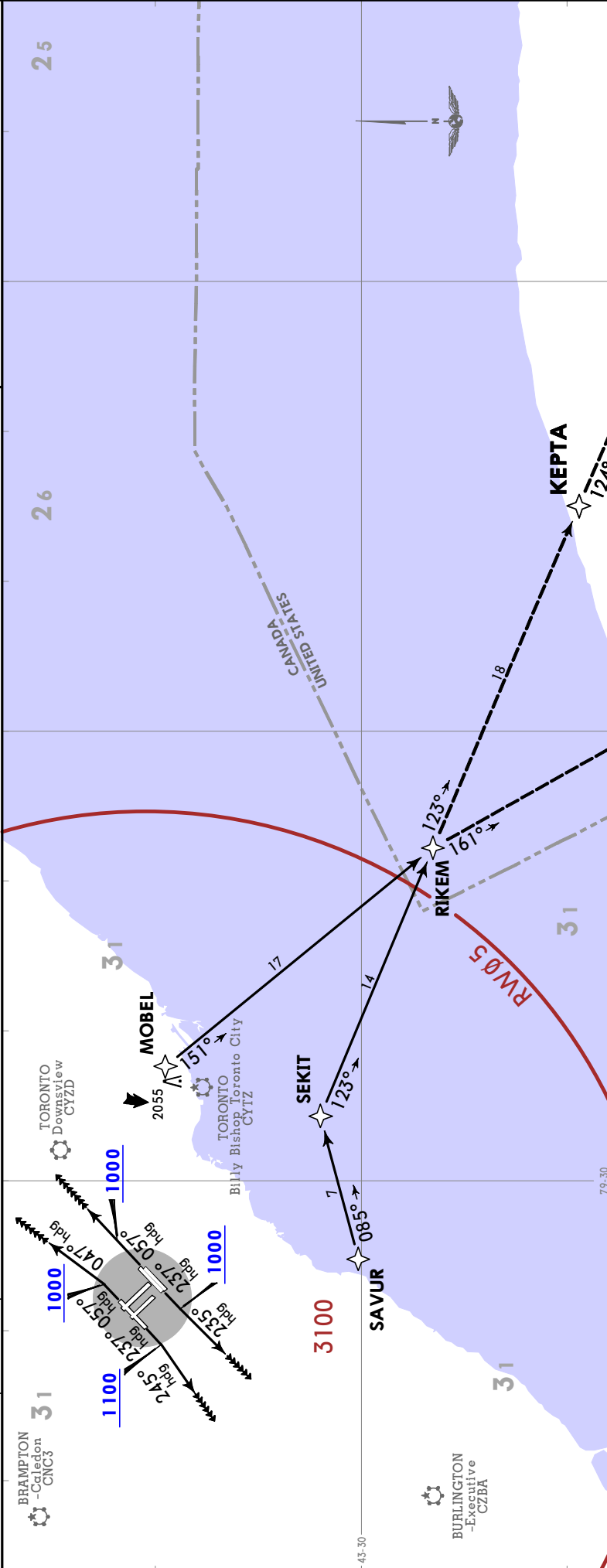

This SID requires minimum climb gradients of:

Rwy 05:	360 per NM to 2700.
Rwy 06L:	400 per NM to 2700.
Rwy 06R:	390 per NM to 2700.
Rwy 24L:	270 per NM to 1700.
Rwy 24R:	260 per NM to 1700.

Grnd speed-KT	75	100	150	200	250	300
260 per NM	325	433	650	867	1083	1300
270 per NM	338	450	675	900	1125	1350
360 per NM	450	600	900	1200	1500	1800
390 per NM	488	650	975	1300	1625	1950
400 per NM	500	667	1000	1333	1667	2000

LOST COMMS: On recognition of failure 20 minutes or less after take-off and in IFR weather conditions proceed as follows:
 1. Select transponder code 7600.
 2. Beyond 10 NM from CYYZ proceed directly on course.
 3. Do not climb above last assigned altitude for 5 minutes after recognition of failure.
 4. Climb to flight planned altitude.

RWY	INITIAL CLIMB	ALTITUDE
05	Unless otherwise assigned by ATC: Climb heading 057° to 1000. Climbing LEFT turn heading 047° or as assigned. EXPECT RADAR vectors to MOBEL (or as assigned), then proceed via depicted route.	Unless otherwise assigned by ATC: MAINTAIN 5000
06L/R	Unless otherwise assigned by ATC: Climb heading 057° to 1000. Continue climb heading 057° or as assigned. EXPECT RADAR vectors to MOBEL (or as assigned), then proceed via depicted route.	
23	Unless otherwise assigned by ATC: Climb heading 237° to 1100. Climbing RIGHT turn heading 245° or as assigned. EXPECT RADAR vectors to SAVUR (or as assigned), then proceed via depicted route.	
24L/R	Unless otherwise assigned by ATC: Climb heading 237° to 1000. Climbing LEFT turn heading 235° or as assigned. EXPECT RADAR vectors to SAVUR (or as assigned), then proceed via depicted route.	

CHANGES: Airport name.

TORONTO, ONT
RNAV SID

JEPPESSEN
28 APR 23
(10-3E3)

CYYZ/YYZ
LESTER B PEARSON INTL

Trans alt: 18000
1. RADAR required.
2. Safe Altitude within 100 NM 4900.
3. Jet aircraft only.
4. For use by GNS5 or D/D/1 equipped aircraft. Aircraft with selectable CDI must be set to 1 NM sensitivity. Aircraft without selectable CDI must use flight director.
5. Refer to 10-4 Noise Abatement Procedures for additional requirements.

KEPTA 3 DEPARTURE (KEPTA3.)
(RWYS 15L/R, 33L/R)

This SID requires minimum climb gradients of:
Rwy 15L: 390 per NM to 3000.
Rwy 15R: 380 per NM to 3000.
Rwy 33L: 250 per NM to 900.

Gnd speed-KT	75	100	150	200	250	300
250 per NM	313	417	625	833	1042	1250
380 per NM	475	633	950	1267	1583	1900
390 per NM	488	650	975	1300	1625	1950

1. Select transponder code 7600.
2. Beyond 10 NM from CYYZ proceed directly on course.
3. Do not climb above last assigned altitude for 5 minutes after recognition of failure.
4. Climb to flight planned altitude.

RWY	INITIAL CLIMB	ALTITUDE
15L/R	Unless otherwise assigned by ATC: Climb heading 147° to 1000. Continue climb heading 147° or as assigned. EXPECT RADAR vectors to RIKEM (or as assigned), then proceed via depicted route.	
33L	Unless otherwise assigned by ATC: Climb heading 327° to 1100. Climbing RIGHT turn heading 345° or as assigned. EXPECT RADAR vectors to VIVET (or as assigned), then proceed via depicted route.	Unless otherwise assigned by ATC: MAINTAIN 5000
33R	Unless otherwise assigned by ATC: Climb heading 327° to 2100. Climbing RIGHT turn heading 340° or as assigned. EXPECT RADAR vectors to VIVET (or as assigned), then proceed via depicted route.	

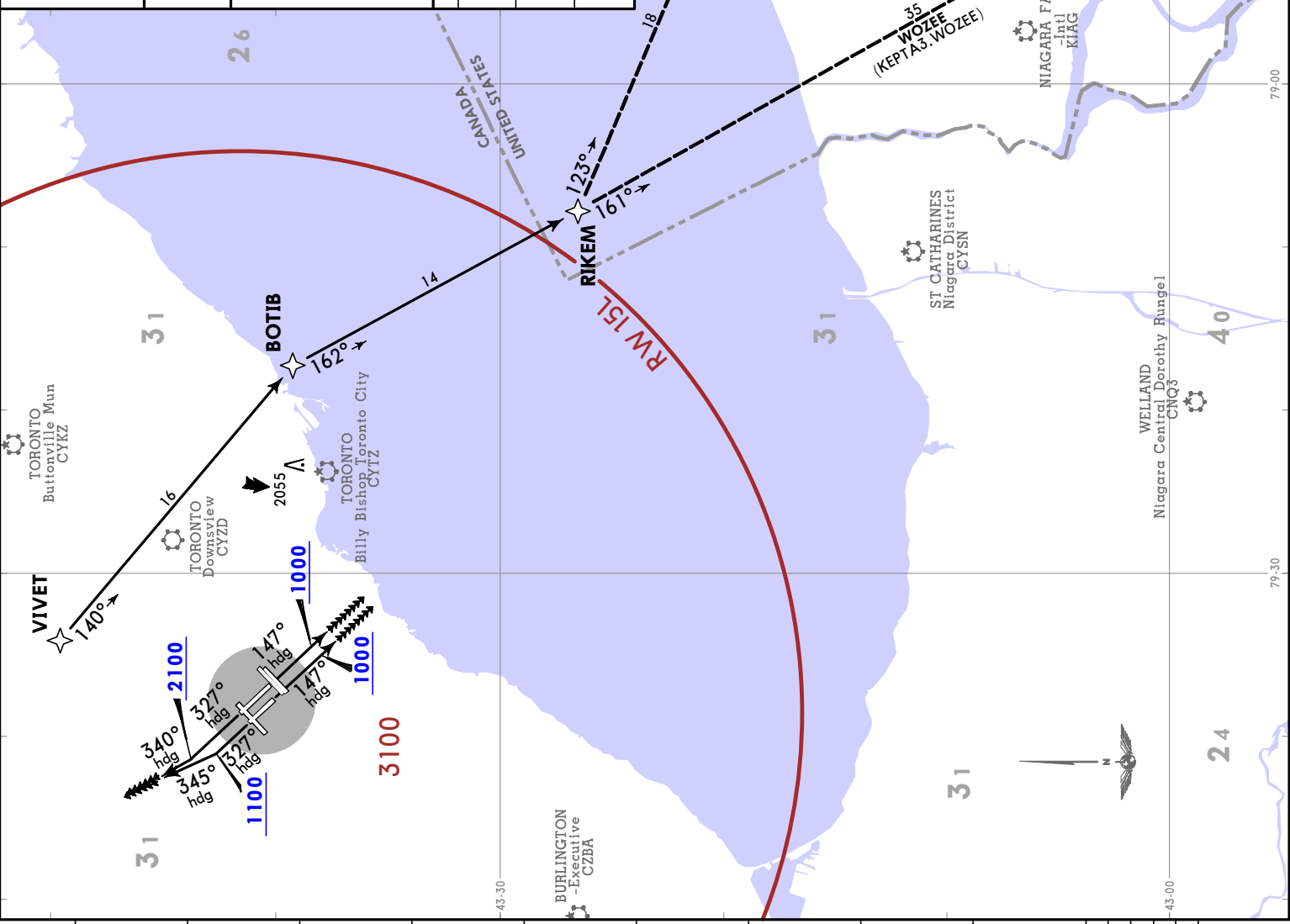

CYYZ/YYZ
LESTER B PEARSON INTL

TORONTO
Departure
128.8 127.575

Apt Elev
569

Trans alt: 18000

1. RADAR required.
2. CAUTION: Rwy 05, 06L/R, 23, 24L/R departures: Simultaneous parallel departures in use.
3. Safe Altitude within 100 NM 4900.

4. Jet aircraft only.
5. For use by GNSS or D/D/1 equipped aircraft. Aircraft with selectable CDI must be set to 1 NM sensitivity. Aircraft without selectable CDI must use flight director.
6. Refer to 10-4 Noise Abatement Procedures for additional requirements.

JEPPESEN TORONTO, ONT
RNAV SID
28 APR 23 (10-3E4)

KISEP 4 DEPARTURE (KISEP4.)
(RWYS 05, 06L/R, 23, 24L/R)

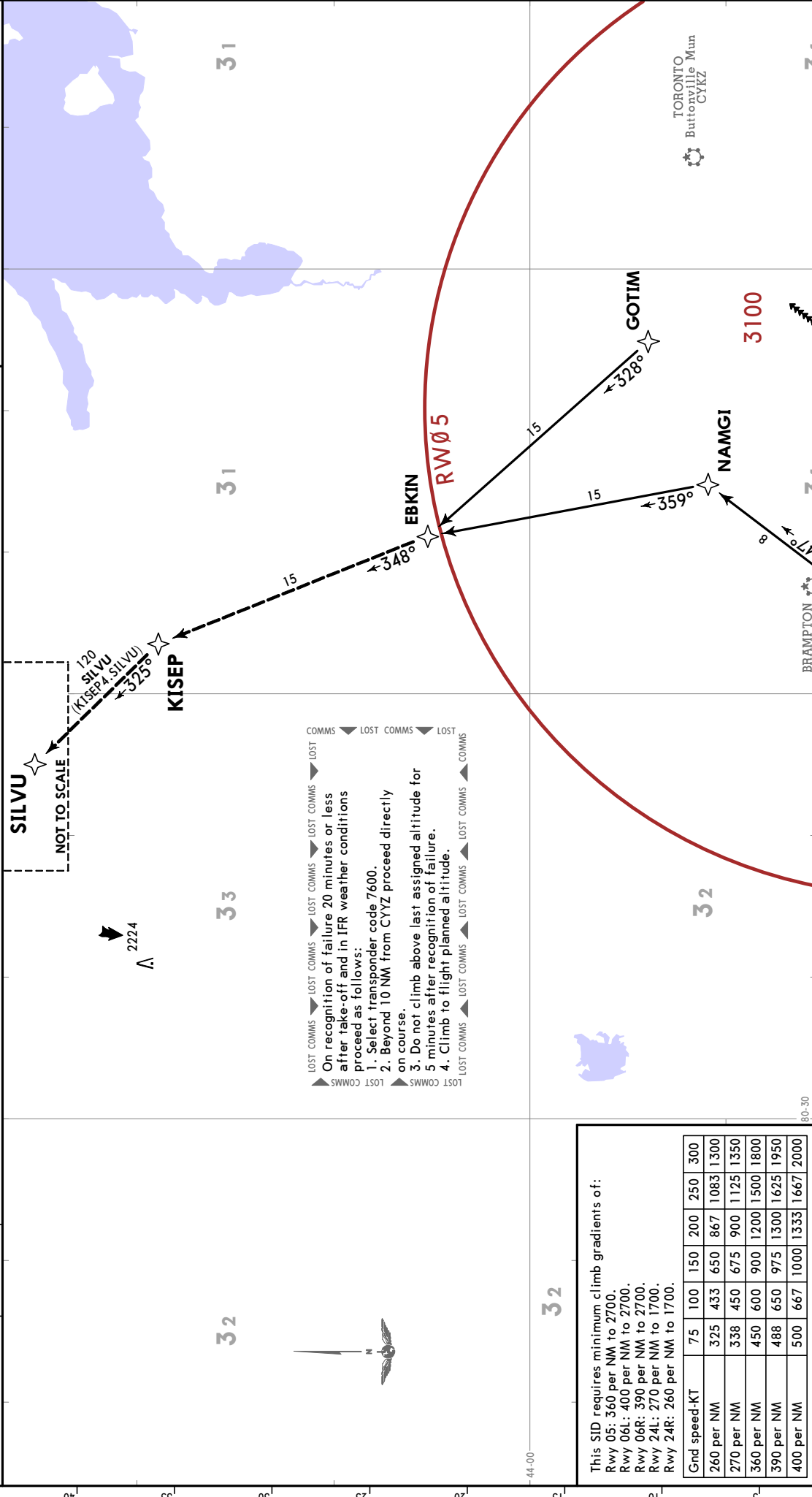

LOST COMMS ◀ LOST COMMS ▶ LOST COMMS ▶ LOST COMMS ▶ LOST
 On recognition of failure 20 minutes or less after take-off and in IFR weather conditions proceed as follows:
 1. Select transponder code 7600.
 2. Beyond 10 NM from CYYZ proceed directly on course.
 3. Do not climb above last assigned altitude for 5 minutes after recognition of failure.
 4. Climb to flight planned altitude.
 LOST COMMS ▶ LOST COMMS ▶ LOST COMMS ▶ LOST COMMS ▶ LOST

This SID requires minimum climb gradients of:
 Rwy 05: 360 per NM to 2700.
 Rwy 06L: 400 per NM to 2700.
 Rwy 06R: 390 per NM to 2700.
 Rwy 24L: 270 per NM to 1700.
 Rwy 24R: 260 per NM to 1700.

Grnd speed-KT	75	100	150	200	250	300
260 per NM	325	433	650	867	1083	1300
270 per NM	338	450	675	900	1125	1350
360 per NM	450	600	900	1200	1500	1800
390 per NM	488	650	975	1300	1625	1950
400 per NM	500	667	1000	1333	1667	2000

RWY	INITIAL CLIMB	ALTITUDE
05	Unless otherwise assigned by ATC: Climb heading 057° to 1000. Climbing LEFT turn heading 047° or as assigned. EXPECT RADAR vectors to GOTIM (or as assigned), then proceed via depicted route.	
06L/R	Unless otherwise assigned by ATC: Climb heading 057° to 1000. Continue climb heading 057° or as assigned. EXPECT RADAR vectors to GOTIM (or as assigned), then proceed via depicted route.	Unless otherwise assigned by ATC: MAINTAIN 5000
23	Unless otherwise assigned by ATC: Climb heading 237° to 1100. Climbing RIGHT turn heading 245° or as assigned. EXPECT RADAR vectors to BISTI (or as assigned), then proceed via depicted route.	
24L/R	Unless otherwise assigned by ATC: Climb heading 237° to 1000. Climbing LEFT turn heading 235° or as assigned. EXPECT RADAR vectors to BISTI (or as assigned), then proceed via depicted route.	

JEPPesen
TORONTO, ONT
RNAV SID

CYYZ/YYZ
LESTER B PEARSON INTL
 28 APR 23
10-3E5

TORONTO Departure
128.8
127.575

Apt Elev
569

Trans alt: 18000
 1. RADAR required.
 2. Safe Altitude within 100 NM 4900.
 3. Jet aircraft only.
 4. For use by GNS5 or D/D/1 equipped aircraft. Aircraft with selectable CDI must be set to 1 NM sensitivity. Aircraft without selectable CDI must use flight director.
 5. Refer to 10-4 Noise Abatement Procedures for additional requirements.

KISEP 4 DEPARTURE (KISEP4.)
(RWYS 15L/R, 33L/R)

This SID requires minimum climb gradients of:

Rwy 15L: 390 per NM to 3000.
 Rwy 15R: 380 per NM to 3000.
 Rwy 33L: 250 per NM to 900.

Gnd speed-KT	75	100	150	200	250	300
250 per NM	313	417	625	833	1042	1250
380 per NM	475	633	950	1267	1583	1900
390 per NM	488	650	975	1300	1625	1950

On recognition of failure 20 minutes or less after take-off and in IFR weather conditions proceed as follows:
 1. Select transponder code 7600.
 2. Beyond 10 NM from CYYZ proceed directly on course.
 3. Do not climb above last assigned altitude for 5 minutes after recognition of failure.
 4. Climb to flight planned altitude.

RWY	INITIAL CLIMB	ALTITUDE
15L/R	Unless otherwise assigned by ATC: Climb heading 147° or as assigned. EXPECT RADAR vectors to BORUX (or as assigned), then proceed via depicted route.	Unless otherwise assigned by ATC: MAINTAIN 5000
33L	Unless otherwise assigned by ATC: Climb heading 327° to 1100. Climbing RIGHT turn heading 345° or as assigned. EXPECT RADAR vectors to EBKIN (or as assigned), then proceed via depicted route.	Unless otherwise assigned by ATC: MAINTAIN 5000
33R	Unless otherwise assigned by ATC: Climb heading 327° to 2100. Climbing RIGHT turn heading 340° or as assigned. EXPECT RADAR vectors to EBKIN (or as assigned), then proceed via depicted route.	Unless otherwise assigned by ATC: MAINTAIN 5000

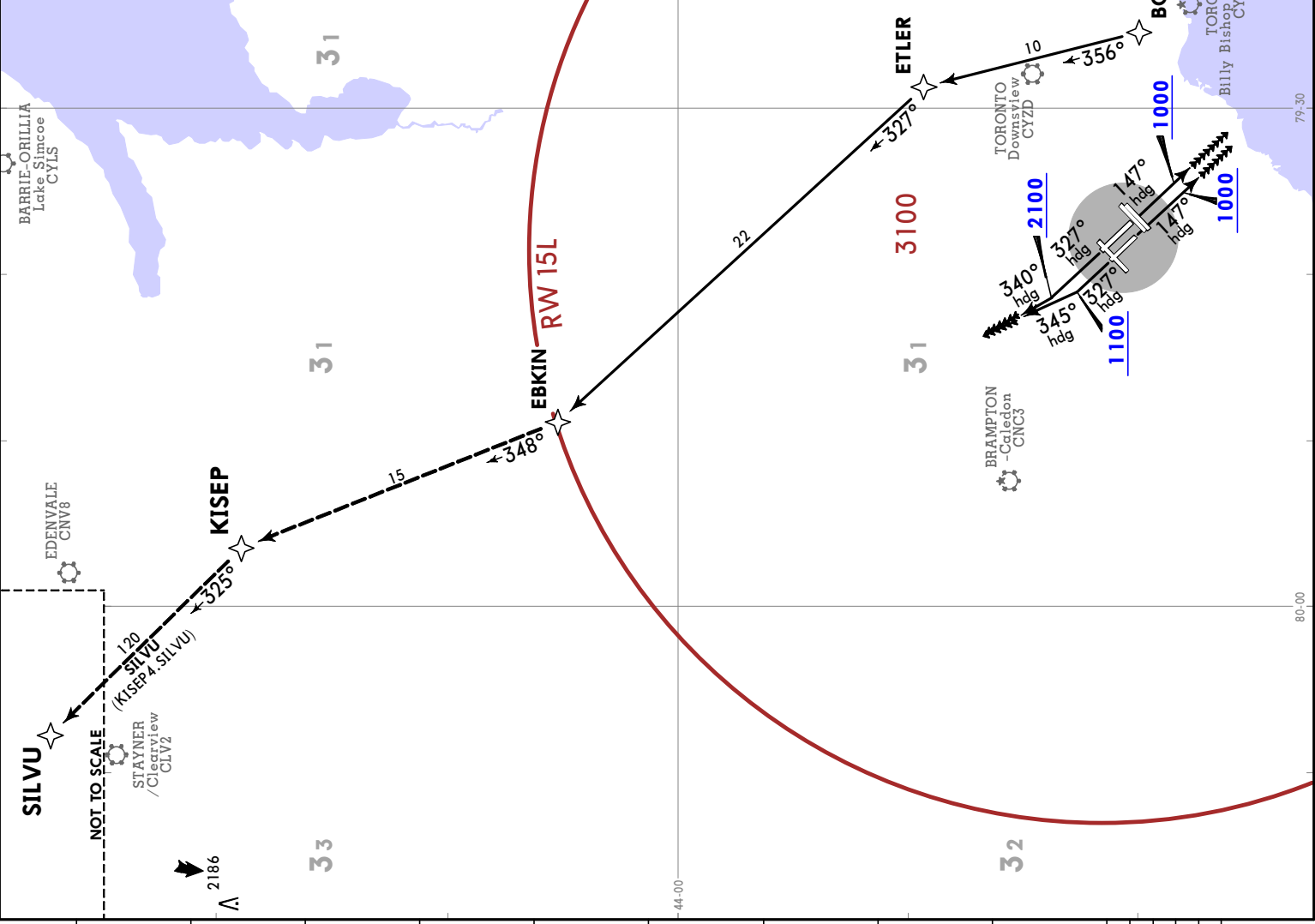

CYYZ/YYZ
LESTER B PEARSON INTL

JEPPESEN
28 APR 23 (10-3F1)

TORONTO, ONT
RNAV SID

Trans alt: 18000
1. RADAR required.
2. Safe Altitude within 100 NM 4900.
3. Non-Jet aircraft only.
4. For use by GNS5 equipped aircraft. GNS5 aircraft with selectable CDI must be set to 1 NM sensitivity. Aircraft without selectable CDI must use flight director.
5. Refer to 10-4 Noise Abatement Procedures for additional requirements.

LAKES 4 DEPARTURE (LAKES4.)
(RWYS 15L/R, 33L/R)

This SID requires minimum climb gradients of:
Rwy 15L: 390 per NM to 3000.
Rwy 15R: 380 per NM to 3000.
Rwy 33L: 250 per NM to 900.

Gnd speed-KT	75	100	150	200	250	300
250 per NM	313	417	625	833	1042	1250
380 per NM	475	633	950	1267	1583	1900
390 per NM	488	650	975	1300	1625	1950

LOST COMMS: On recognition of failure 20 minutes or less after take-off and in IFR weather conditions proceed as follows:
1. Select transponder code 7600.
2. Beyond 10 NM from CYYZ proceed directly on course.
3. Do not climb above last assigned altitude for 5 minutes after recognition of failure.
4. Climb to flight planned altitude.

RWY	INITIAL CLIMB	ALTITUDE
15L/R	Unless otherwise assigned by ATC: Climb heading 147° to 1000. Continue climb heading 147° or as assigned. EXPECT RADAR vectors to ETLER (or as assigned), then proceed via depicted route.	Unless otherwise assigned by ATC: MAINTAIN 3000. Aircraft assigned a turn at takeoff; commence turn at 1100
33L	Unless otherwise assigned by ATC: Climb heading 327° to 1100. Climbing RIGHT turn heading 345° or as assigned. EXPECT RADAR vectors to SEDOG (or as assigned), then proceed via depicted route.	
33R	Unless otherwise assigned by ATC: Climb heading 327° to 2100. Climbing RIGHT turn heading 340° or as assigned. EXPECT RADAR vectors to SEDOG (or as assigned), then proceed via depicted route.	

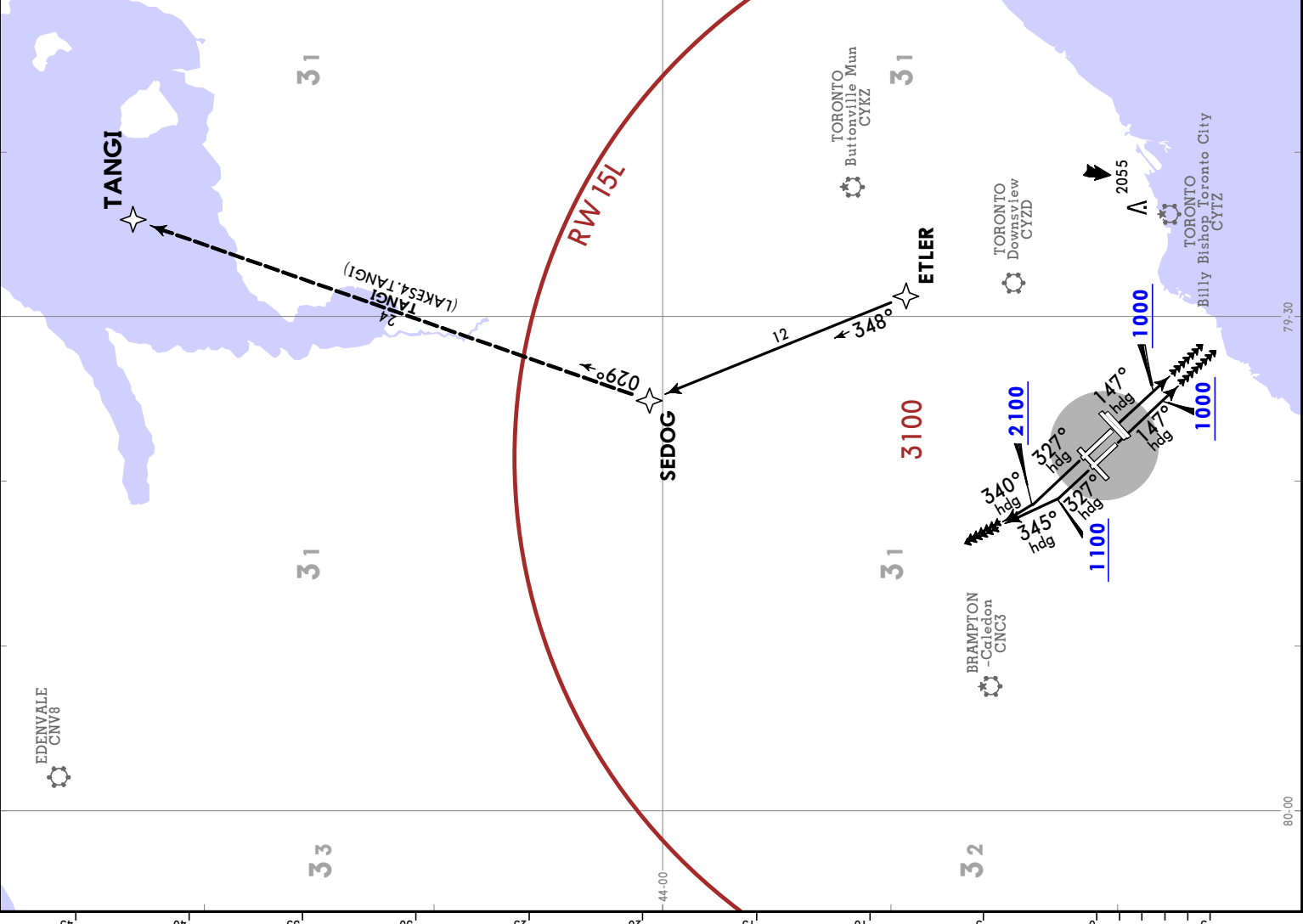

MATES 6 DEPARTURE (MATES6.)
(RWYS 05, 06L/R, 23, 24L/R)

4. Non-Jet aircraft only.
 5. For use by GNSS equipped aircraft. GNSS aircraft with selectable CDI must be set to 1 NM sensitivity. Aircraft without selectable CDI must use flight director.
 6. Refer to 10-4 Noise Abatement Procedures for additional requirements.

Trans alt: 18000
 1. RADAR required.
 2. CAUTION: Rwys 05, 06L/R, 23, 24L/R departures: Simultaneous parallel departures in use.
 3. Safe Altitude within 100 NM 4900.

TORONTO
 Departure
128.8 127.575
 Apt Elev
569

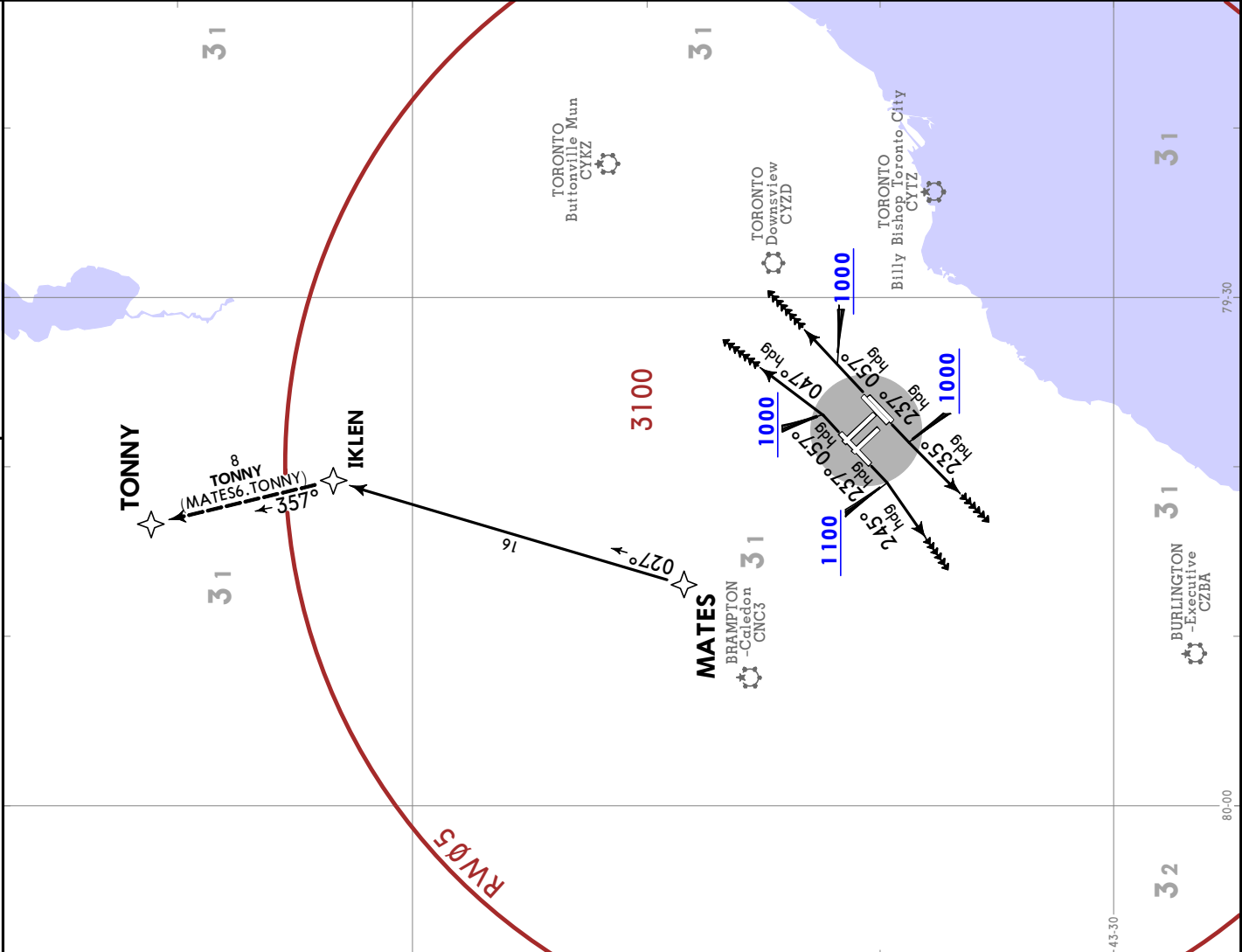

RWY	INITIAL CLIMB										ALTITUDE
05	Unless otherwise assigned by ATC: Climb heading 057° to 1000. Climbing LEFT turn heading 047° or as assigned. EXPECT RADAR vectors to IKLEN (or as assigned), then proceed via depicted route.										Unless otherwise assigned by ATC: MAINTAIN 3000. Aircraft assigned a turn at takeoff; commence turn at 1100
06L/R	Unless otherwise assigned by ATC: Climb heading 057° to 1000. Continue climb heading 057° or as assigned. EXPECT RADAR vectors to IKLEN (or as assigned), then proceed via depicted route.										
23	Unless otherwise assigned by ATC: Climb heading 237° to 1100. Climbing RIGHT turn heading 245° or as assigned. EXPECT RADAR vectors to MATES (or as assigned), then proceed via depicted route.										Unless otherwise assigned by ATC: Climb heading 237° to 1000. Climbing LEFT turn heading 235° or as assigned. EXPECT RADAR vectors to MATES (or as assigned), then proceed via depicted route.
24L/R	Unless otherwise assigned by ATC: Climb heading 237° to 1000. Climbing LEFT turn heading 235° or as assigned. EXPECT RADAR vectors to MATES (or as assigned), then proceed via depicted route.										

This SID requires minimum climb gradients of:
 Rwy 05: 360 per NM to 2700.
 Rwy 06L: 400 per NM to 2700.
 Rwy 06R: 390 per NM to 2700.
 Rwy 24L: 270 per NM to 1700.
 Rwy 24R: 260 per NM to 1700.

Gnd speed-KT	75	100	150	200	250	300
260 per NM	325	433	650	867	1083	1300
270 per NM	338	450	675	900	1125	1350
360 per NM	450	600	900	1200	1500	1800
390 per NM	488	650	975	1300	1625	1950
400 per NM	500	667	1000	1333	1667	2000

- LOST COMMS
1. Select transponder code 7600.
 2. Beyond 10 NM from CYZD proceed directly on course.
 3. Do not climb above last assigned altitude for 5 minutes after recognition of failure.
 4. Climb to flight planned altitude.

LOST COMMS

On recognition of failure 20 minutes or less after take-off and in IFR weather conditions proceed as follows:

LOST COMMS

LOST COMMS

JEPPESEN
CYYZ/YYZ
LESTER B PEARSON INTL
 28 APR 23 (10-3G1)
RNAV SID

TORONTO, ONT

Trans alt: 18000
 1. RADAR required.
 2. Safe Altitude within 100 NM 4900.
 3. Non-Jet aircraft only.
 4. For use by GNSs equipped aircraft. GNSs aircraft with selectable CDI must be set to 1 NM sensitivity. Aircraft without selectable CDI must use flight director.
 5. Refer to 10-4 Noise Abatement Procedures for additional requirements.

TORONTO Departure
 128.8
 127.575

Apt Elev
 569

MATES 6 DEPARTURE (MATES6.)
(RWYS 15L/R, 33L/R)

This SID requires minimum climb gradients of:
 Rwy 15L: 390 per NM to 3000.
 Rwy 15R: 380 per NM to 3000.
 Rwy 33L: 250 per NM to 900.

Gnd speed-KT	75	100	150	200	250	300
250 per NM	313	417	625	833	1042	1250
380 per NM	475	633	950	1267	1583	1900
390 per NM	488	650	975	1300	1625	1950

On recognition of failure 20 minutes or less after take-off and in IFR weather conditions proceed as follows:
 1. Select transponder code 7600.
 2. Beyond 10 NM from CYYZ proceed directly on course.
 3. Do not climb above last assigned altitude for 5 minutes after recognition of failure.
 4. Climb to flight planned altitude.

RWY	INITIAL CLIMB	ALTITUDE
15L/R	Unless otherwise assigned by ATC: Climb heading 147° to 1000. Continue climb heading 147° or as assigned. EXPECT RADAR vectors to ETLER (or as assigned), then proceed via depicted route.	Unless otherwise assigned by ATC: MAINTAIN 3000. Aircraft assigned a turn at takeoff; commence turn at 1100
33L	Unless otherwise assigned by ATC: Climb heading 327° to 1100. Climbing RIGHT turn heading 345° or as assigned. EXPECT RADAR vectors to IKLEN (or as assigned), then proceed via depicted route.	
33R	Unless otherwise assigned by ATC: Climb heading 327° to 2100. Climbing RIGHT turn heading 340° or as assigned. EXPECT RADAR vectors to IKLEN (or as assigned), then proceed via depicted route.	

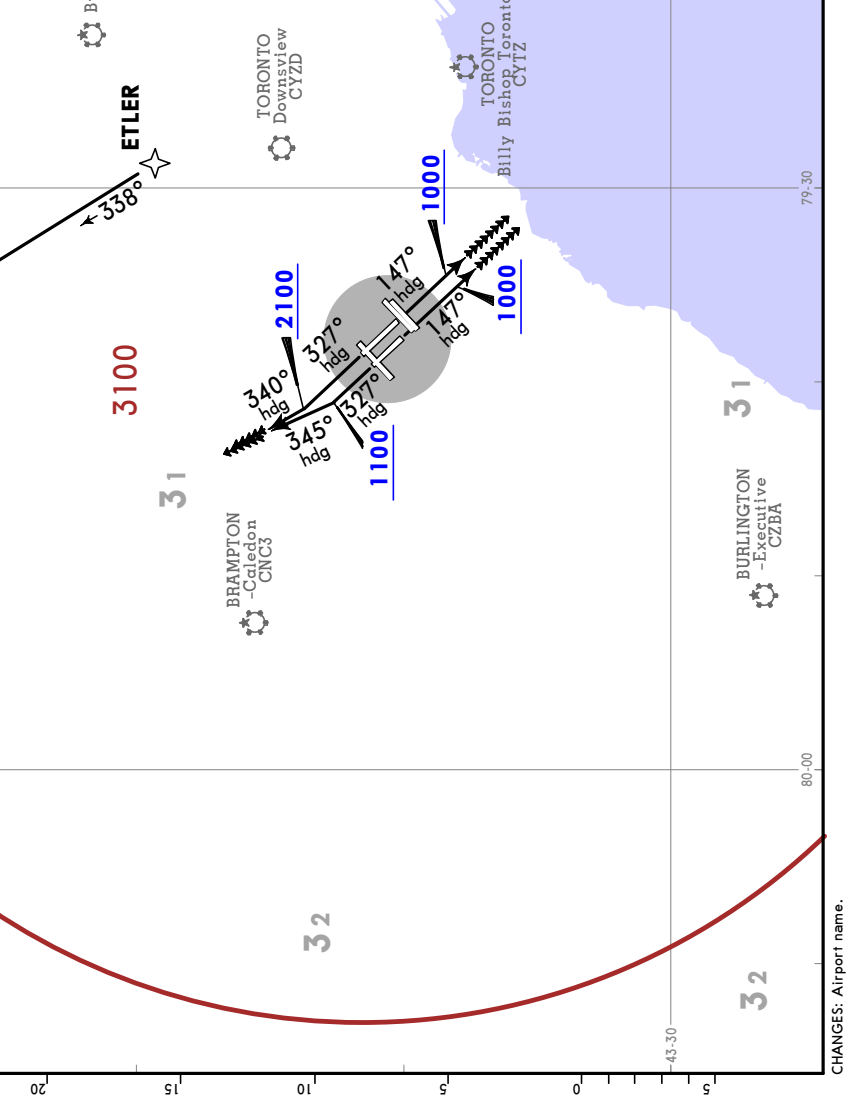
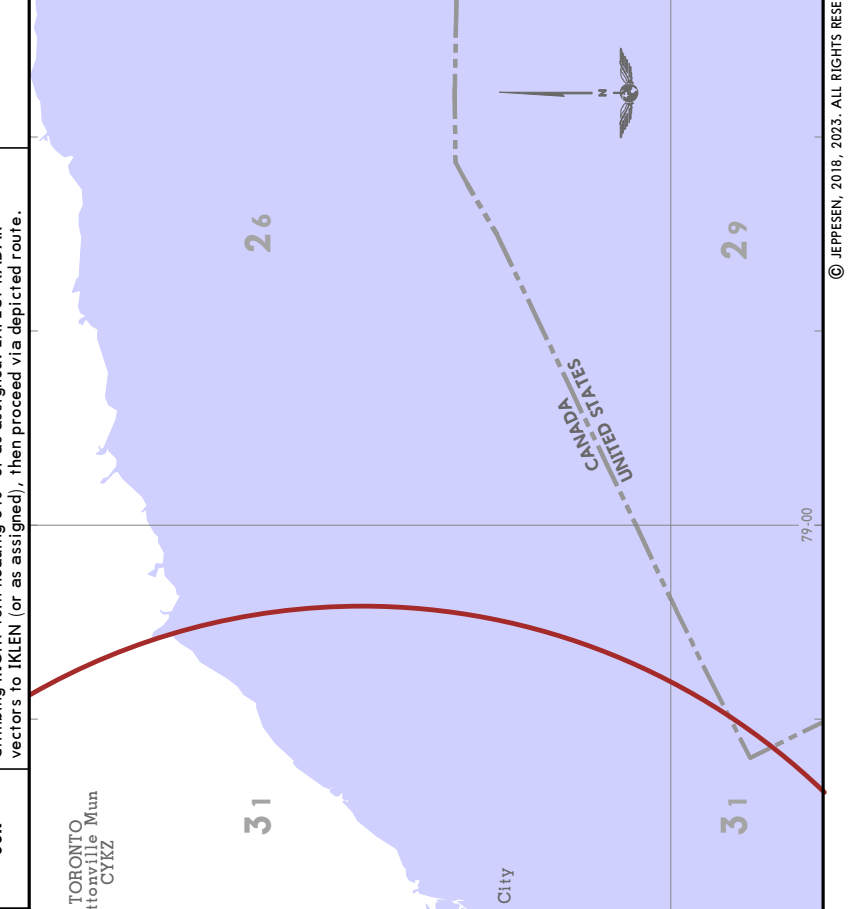
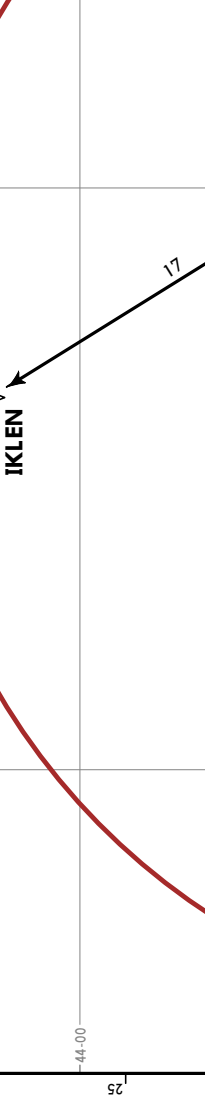

MAVAN 3 DEPARTURE (MAVAN3.)
 (RWYS 05, 06L/R, 23, 24L/R)

- 4. Non-jet aircraft only.
- 5. For use by GNSSE equipped aircraft. GNSSE aircraft with selectable CDI must be set to 1 NM sensitivity. Aircraft without selectable CDI must use flight director.
- 6. Refer to 10-4 Noise Abatement Procedures for additional requirements.

Trans alt: 18000
 1. RADAR required.
 2. CAUTION: Rws 05, 06L/R, 23, 24L/R departures: Simultaneous parallel departures in use.
 3. Safe Altitude within 100 NM 4900.

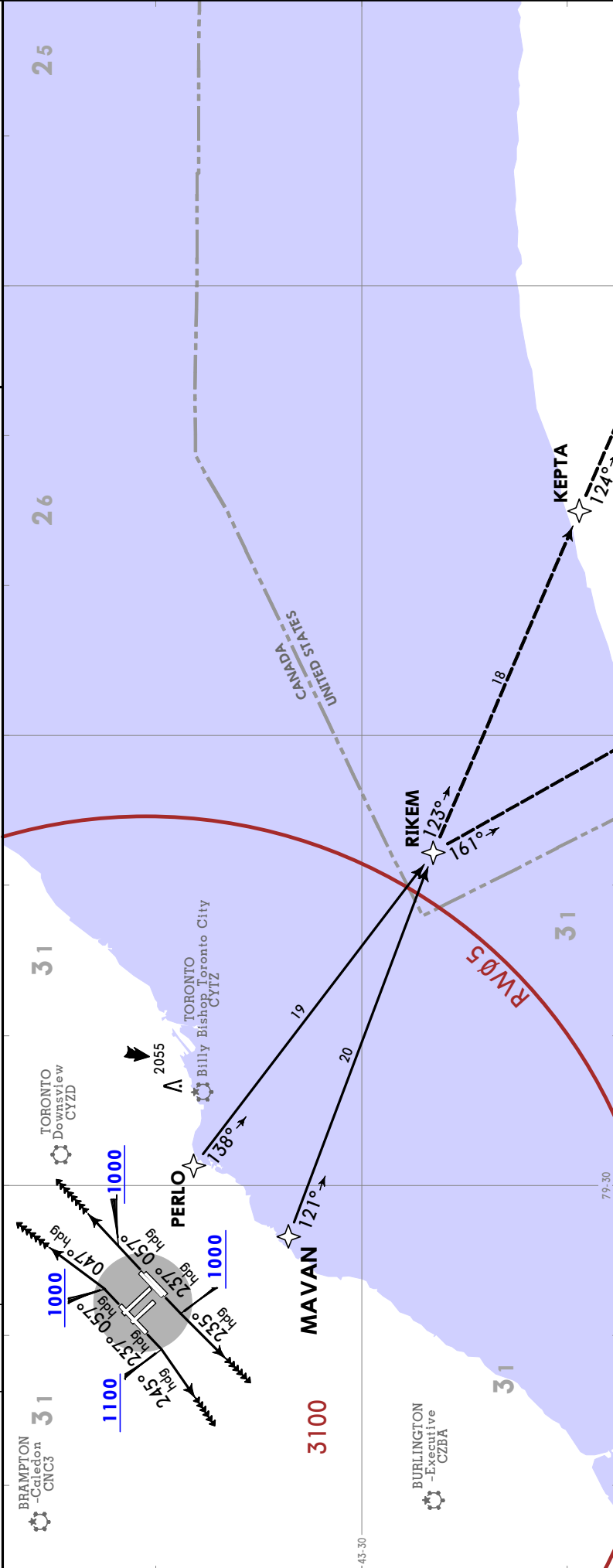

This SID requires minimum climb gradients of:

Rwy 05:	360 per NM to 2700.
Rwy 06L:	400 per NM to 2700.
Rwy 06R:	390 per NM to 1700.
Rwy 24L:	270 per NM to 1700.
Rwy 24R:	260 per NM to 1700.

Grnd speed-KT	75	100	150	200	250	300
260 per NM	325	433	650	867	1083	1300
270 per NM	338	450	675	900	1125	1350
360 per NM	450	600	900	1200	1500	1800
390 per NM	488	650	975	1300	1625	1950
400 per NM	500	667	1000	1333	1667	2000

LOST COMMS: On recognition of failure 20 minutes or less after take-off and in IFR weather conditions proceed as follows:
 1. Select transponder code 7600.
 2. Beyond 10 NM from CYZD proceed directly on course.
 3. Do not climb above last assigned altitude for 5 minutes after recognition of failure.
 4. Climb to flight planned altitude.

RWY	INITIAL CLIMB	ALTITUDE
05	Unless otherwise assigned by ATC: Climb heading 057° to 1000. Climbing LEFT turn heading 047° or as assigned. EXPECT RADAR vectors to PERLO (or as assigned), then proceed via depicted route.	Unless otherwise assigned by ATC: MAINTAIN 3000. Aircraft assigned a turn at takeoff; commence turn at 1100
06L/R	Unless otherwise assigned by ATC: Climb heading 057° to 1000. Continue climb heading 057° or as assigned. EXPECT RADAR vectors to PERLO (or as assigned), then proceed via depicted route.	
23	Unless otherwise assigned by ATC: Climb heading 237° to 1100. Climbing RIGHT turn heading 245° or as assigned. EXPECT RADAR vectors to MAVAN (or as assigned), then proceed via depicted route.	
24L/R	Unless otherwise assigned by ATC: Climb heading 237° to 1000. Climbing LEFT turn heading 235° or as assigned. EXPECT RADAR vectors to MAVAN (or as assigned), then proceed via depicted route.	

JEPPESEN
CYYZ/YYZ
LESTER B PEARSON INTL
 28 APR 23
(10-3G3)
RNAV SID

TORONTO, ONT

Trans alt: 18000
 1. RADAR required.
 2. Safe Altitude within 100 NM 4900.
 3. Non-Jet aircraft only.
 4. For use by GNSSE equipped aircraft. GNSSE aircraft with selectable CDI must be set to 1 NM sensitivity. Aircraft without selectable CDI must use flight director.
 5. Refer to 10-4 Noise Abatement Procedures for additional requirements.

TORONTO Departure
 128.8
 127.575

Apt Elev
 569

MAVAN 3 DEPARTURE (MAVAN3.)
(RWYS 15L/R, 33L/R)

LOST COMMS
 On recognition of failure 20 minutes or less after take-off and in IFR weather conditions proceed as follows:
 1. Select transponder code 7600.
 2. Beyond 10 NM from CYYZ proceed directly on course.
 3. Do not climb above last assigned altitude for 5 minutes after recognition of failure.
 4. Climb to flight planned altitude.

This SID requires minimum climb gradients of:

Rwy 15L: 390 per NM to 3000.	75	100	150	200	250	300
Rwy 15R: 380 per NM to 3000.	313	417	625	833	1042	1250
Rwy 33L: 250 per NM to 900.	475	633	950	1267	1583	1900
	390	650	975	1300	1625	1950

RWY	INITIAL CLIMB	ALTITUDE
15L/R	Unless otherwise assigned by ATC: Climb heading 147° to 1000. Continue climb heading 147° or as assigned. EXPECT RADAR vectors to RIKEM (or as assigned), then proceed via depicted route.	Unless otherwise assigned by ATC: MAINTAIN 3000. Aircraft assigned a turn at takeoff; commence turn at 1100
33L	Unless otherwise assigned by ATC: Climb heading 327° to 1100. Climbing RIGHT turn heading 345° or as assigned. EXPECT RADAR vectors to NUBAN (or as assigned), then proceed via depicted route.	
33R	Unless otherwise assigned by ATC: Climb heading 327° to 2100. Climbing RIGHT turn heading 340° or as assigned. EXPECT RADAR vectors to NUBAN (or as assigned), then proceed via depicted route.	

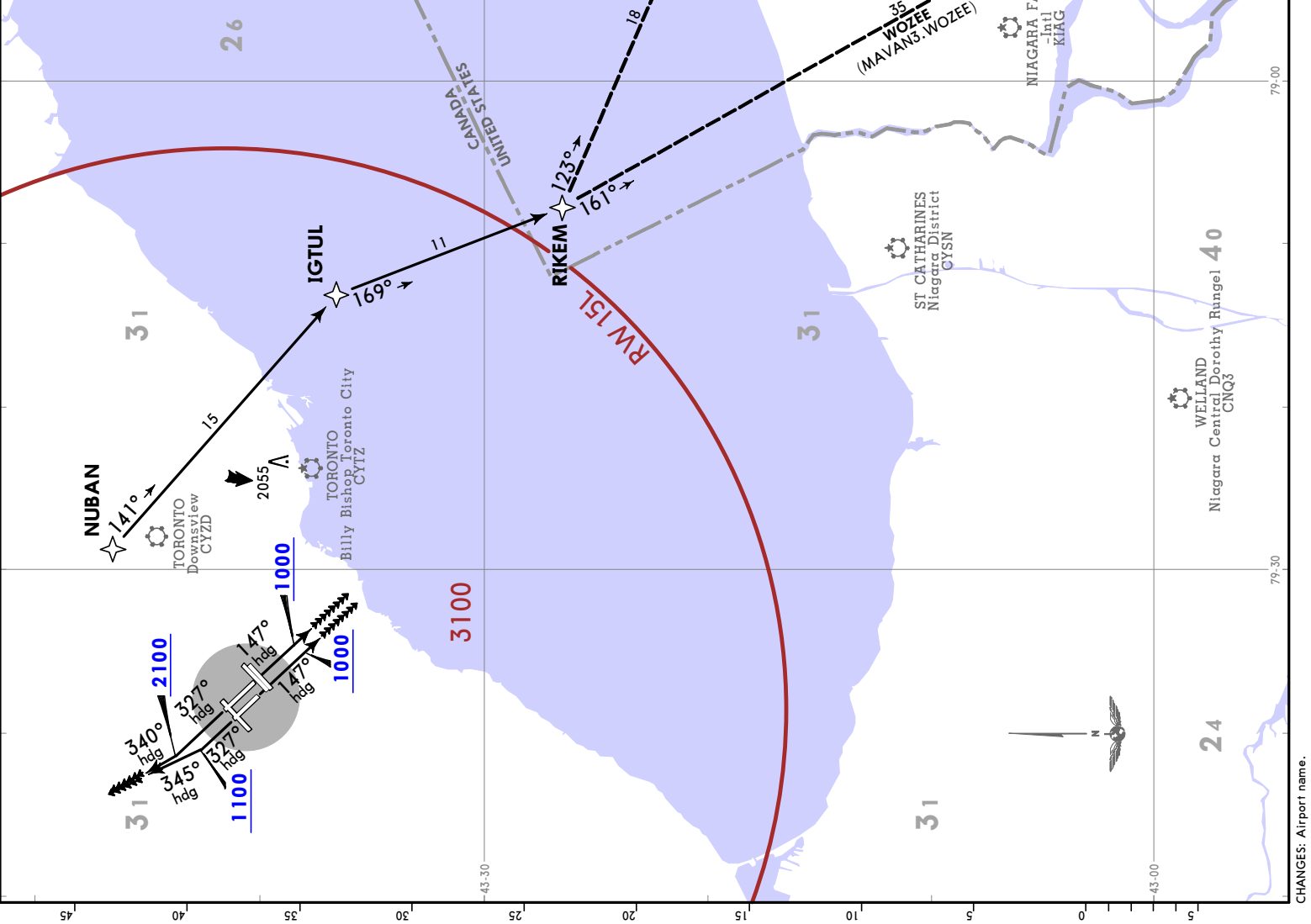

MIXUT 7 DEPARTURE (MIXUT7.)
(RWYS 05, 06L/R, 23, 24L/R)

Trans alt: 18000
 1. RADAR required.
 2. CAUTION: Rwys 05, 06L/R, 23, 24L/R departures: Simultaneous parallel departures in use.
 3. Safe Altitude within 100 NM 4900.
 4. Jet aircraft only.
 5. For use by GNSs od D/D/I equipped aircraft. Aircraft with selectable CDI must be set to 1 NM sensitivity. Aircraft without selectable CDI must use flight director.
 6. Refer to 10-4 Noise Abatement Procedures for additional requirements.

BRAMPTON -Caledon
 CNC3
 TORONTO
 Downsview
 CYZD
 TORONTO
 Billy Bishop
 Toronto City
 CYTZ

BURLINGTON
 -Executive
 CZBA
 KITCHENER
 Waterloo
 CYKF
 STRATFORD
 MILITARY
 CYSA

TORONTO
 Departure
128.8 **127.575**
 Apt Elev
569

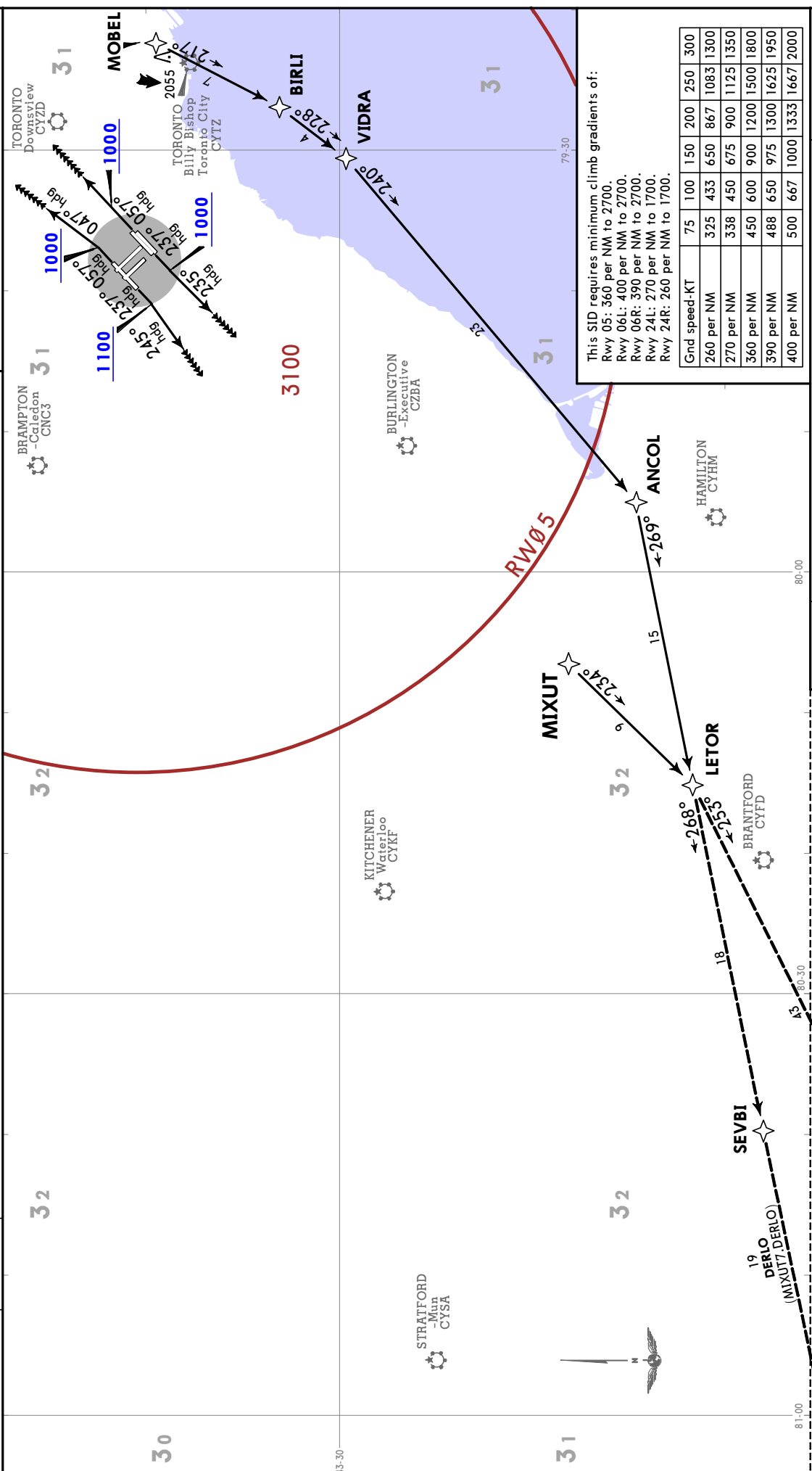

RWY	INITIAL CLIMB	ALTITUDE
05	Unless otherwise assigned by ATC: Climb heading 057° to 1000. Climbing LEFT turn heading 047° or as assigned. EXPECT RADAR vectors to MOBEL (or as assigned), then proceed via depicted route.	
06L/R	Unless otherwise assigned by ATC: Climb heading 057° to 1000. Continue climb heading 057° or as assigned. EXPECT RADAR vectors to MOBEL (or as assigned), then proceed via depicted route.	
23	Unless otherwise assigned by ATC: Climb heading 237° to 1100. Climbing RIGHT turn heading 245° or as assigned. EXPECT RADAR vectors to MIXUT (or as assigned), then proceed via depicted route.	
24L/R	Unless otherwise assigned by ATC: Climb heading 237° to 1000. Climbing LEFT turn heading 235° or as assigned. EXPECT RADAR vectors to MIXUT (or as assigned), then proceed via depicted route.	

NOT TO SCALE

LOST COMMS
 On recognition of failure 20 minutes or less after take-off and in IFR weather conditions proceed as follows:
 1. Select transponder code 7600.
 2. Beyond 10 NM from CYYZ proceed directly on course.
 3. Do not climb above last assigned altitude for 5 minutes after recognition of failure.
 4. Climb to flight planned altitude.

COMMIS
 LOST COMMIS
 LOST COMMIS

JEPPESSEN
 28 APR 23 (10-3G5)
CYZZ/YYZ
 LESTER B PEARSON INTL

TORONTO, ONT
RNAV SID

MIXUT 7 DEPARTURE (MIXUT7.)
 (RWYS 15L/R, 33L/R)

Trans alt: 18000
 1. RADAR required.
 2. Safe Altitude within 100 NM 4900.
 3. Jet aircraft only.

Apt Elev
569

TORONTO
 Departure
128.8 127.575

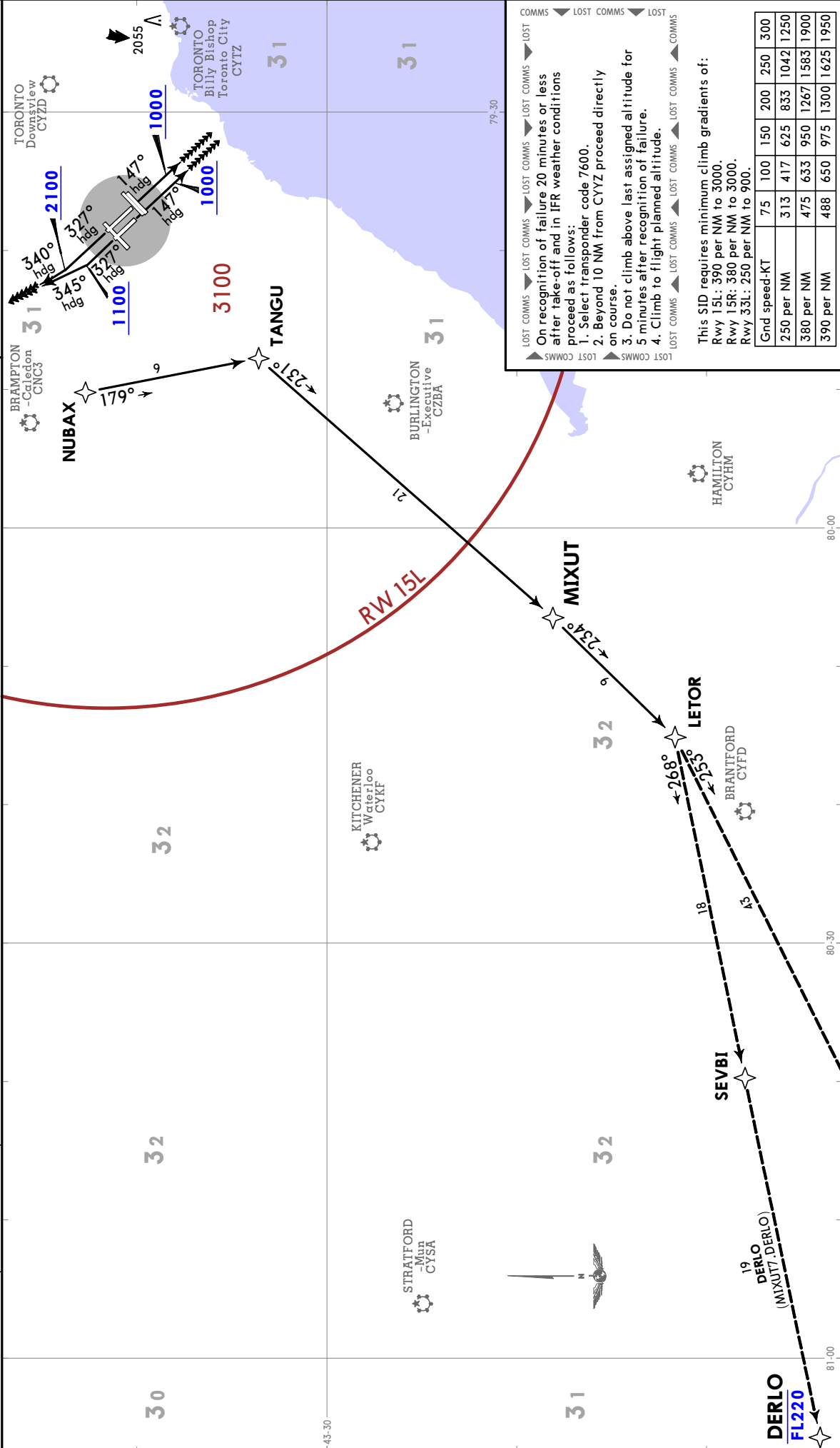

RWY	INITIAL CLIMB	ALTITUDE
15L/R	Unless otherwise assigned by ATC: Climb heading 147° to 1000. Continue climb heading 147° or as assigned. EXPECT RADAR vectors to MIXUT (or as assigned), then proceed via depicted route.	
33L	Unless otherwise assigned by ATC: Climb heading 327° to 1100. Climbing RIGHT turn heading 345° or as assigned. EXPECT RADAR vectors to NUBAX (or as assigned), then proceed via depicted route.	Unless otherwise assigned by ATC: MAINTAIN 5000.
33R	Unless otherwise assigned by ATC: Climb heading 327° to 2100. Climbing RIGHT turn heading 340° or as assigned. EXPECT RADAR vectors to NUBAX (or as assigned), then proceed via depicted route.	

NOSIK 4 DEPARTURE (NOSIK4.)
(RWYS 05, 06L/R, 23, 24L/R)

4. Non-Jet aircraft only.
 5. For use by GNSSE equipped aircraft. GNSSE aircraft with selectable CDI must be set to 1 NM sensitivity. Aircraft without selectable CDI must use flight director.
 6. Refer to 10-4 Noise Abatement Procedures for additional requirements.

Trans alt: 18000
 1. RADAR required.
 2. CAUTION: Rwy 05, 06L/R, 23, 24L/R departures: Simultaneous parallel departures in use.
 3. Safe Altitude within 100 NM 4900.

TORONTO Departure
128.8 127.575
 Apt Elev
569

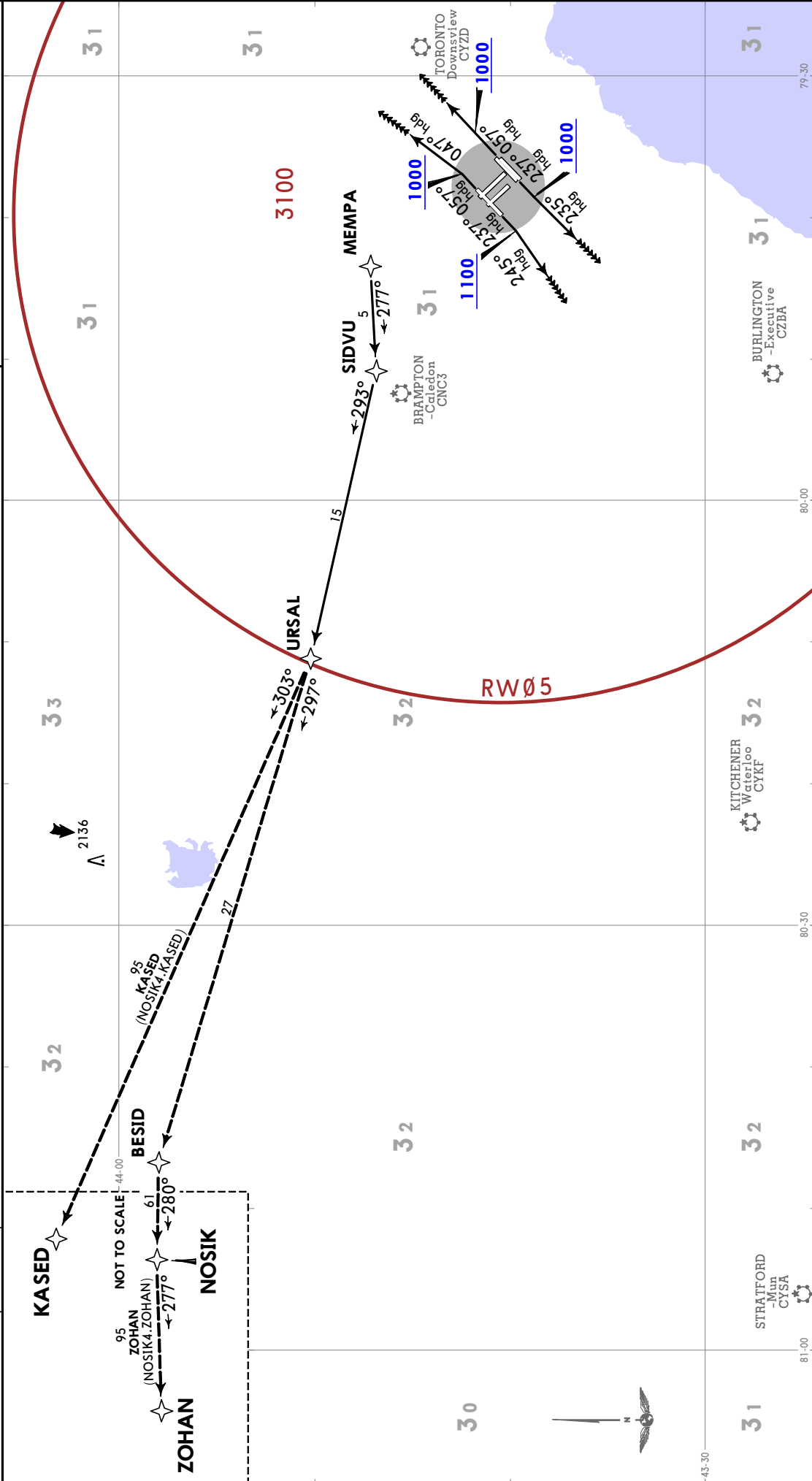

RWY	INITIAL CLIMB	ALTITUDE
05	Unless otherwise assigned by ATC: Climb heading 057° to 1000. Climbing LEFT turn heading 047° or as assigned. EXPECT RADAR vectors to MEMPA (or as assigned), then proceed via depicted route.	Unless otherwise assigned by ATC: MAINTAIN 3000. Aircraft assigned a turn at takeoff; commence turn at 1100
06L/R	Unless otherwise assigned by ATC: Climb heading 057° to 1000. Continue climb heading 057° or as assigned. EXPECT RADAR vectors to MEMPA (or as assigned), then proceed via depicted route.	
23	Unless otherwise assigned by ATC: Climb heading 237° to 1100. Climbing RIGHT turn heading 245° or as assigned. EXPECT RADAR vectors to URSAL (or as assigned), then proceed via depicted route.	
24L/R	Unless otherwise assigned by ATC: Climb heading 237° to 1000. Climbing LEFT turn heading 235° or as assigned. EXPECT RADAR vectors to URSAL (or as assigned), then proceed via depicted route.	

LOST COMMS ◀ LOST COMMS ▶ LOST COMMS ▶ LOST
 On recognition of failure 20 minutes or less after take-off and in IFR weather conditions proceed as follows:
 1. Select transmitter code 7600.
 2. Beyond 10 NM from CYYZ proceed directly on course.
 3. Do not climb above last assigned altitude for 5 minutes after recognition of failure.
 4. Climb to flight planned altitude.

This SID requires minimum climb gradients of:

Rwy	05	06L/R	23	24L/R		
Gnd speed-KT	75	100	150	200	250	300
260 per NM	325	433	650	867	1083	1300
270 per NM	338	450	675	900	1125	1350
360 per NM	450	600	900	1200	1500	1800
390 per NM	488	650	975	1300	1625	1950
400 per NM	500	667	1000	1333	1667	2000

JEPPESEN
 TORONTO, ONT
RNAV SID

CYYZ/YYZ
 LESTER B PEARSON INTL
 28 APR 23
 (10-3H1)

Trans alt: 18000
 1. RADAR required.
 2. Safe Altitude within 100 NM 4900.
 3. Non-Jet aircraft only.
 4. For use by GNSSE equipped aircraft. GNSSE aircraft with selectable CDI must be set to 1 NM sensitivity. Aircraft without selectable CDI must use flight director.
 5. Refer to 10-4 Noise Abatement Procedures for additional requirements.

TORONTO Departure
 128.8
 127.575

Apt Elev
 569

NOSIK 4 DEPARTURE (NOSIK4.)
 (RWYS 15L/R, 33L/R)

This SID requires minimum climb gradients of:

Rwy 15L: 390 per NM to 3000.
 Rwy 15R: 380 per NM to 3000.
 Rwy 33L: 250 per NM to 900.

Gnd speed-KT	75	100	150	200	250	300
250 per NM	313	417	625	833	1042	1250
380 per NM	475	633	950	1267	1583	1900
390 per NM	488	650	975	1300	1625	1950

LOST COMMS
 On recognition of failure 20 minutes or less after take-off and in IFR weather conditions proceed as follows:
 1. Select transponder code 7600.
 2. Beyond 10 NM from CYYZ proceed directly on course.
 3. Do not climb above last assigned altitude for 5 minutes after recognition of failure.
 4. Climb to flight planned altitude.

RWY	INITIAL CLIMB	ALTITUDE
15L/R	Unless otherwise assigned by ATC: Climb heading 147° to 1000. Continue climb heading 147° or as assigned. EXPECT RADAR vectors to IPSOT (or as assigned), then proceed via depicted route.	Unless otherwise assigned by ATC: MAINTAIN 3000. Aircraft assigned a turn at takeoff; commence turn at 1100
33L	Unless otherwise assigned by ATC: Climb heading 327° to 1100. Climbing RIGHT turn heading 345° or as assigned. EXPECT RADAR vectors to URSAL (or as assigned), then proceed via depicted route.	
33R	Unless otherwise assigned by ATC: Climb heading 327° to 2100. Climbing RIGHT turn heading 340° or as assigned. EXPECT RADAR vectors to URSAL (or as assigned), then proceed via depicted route.	

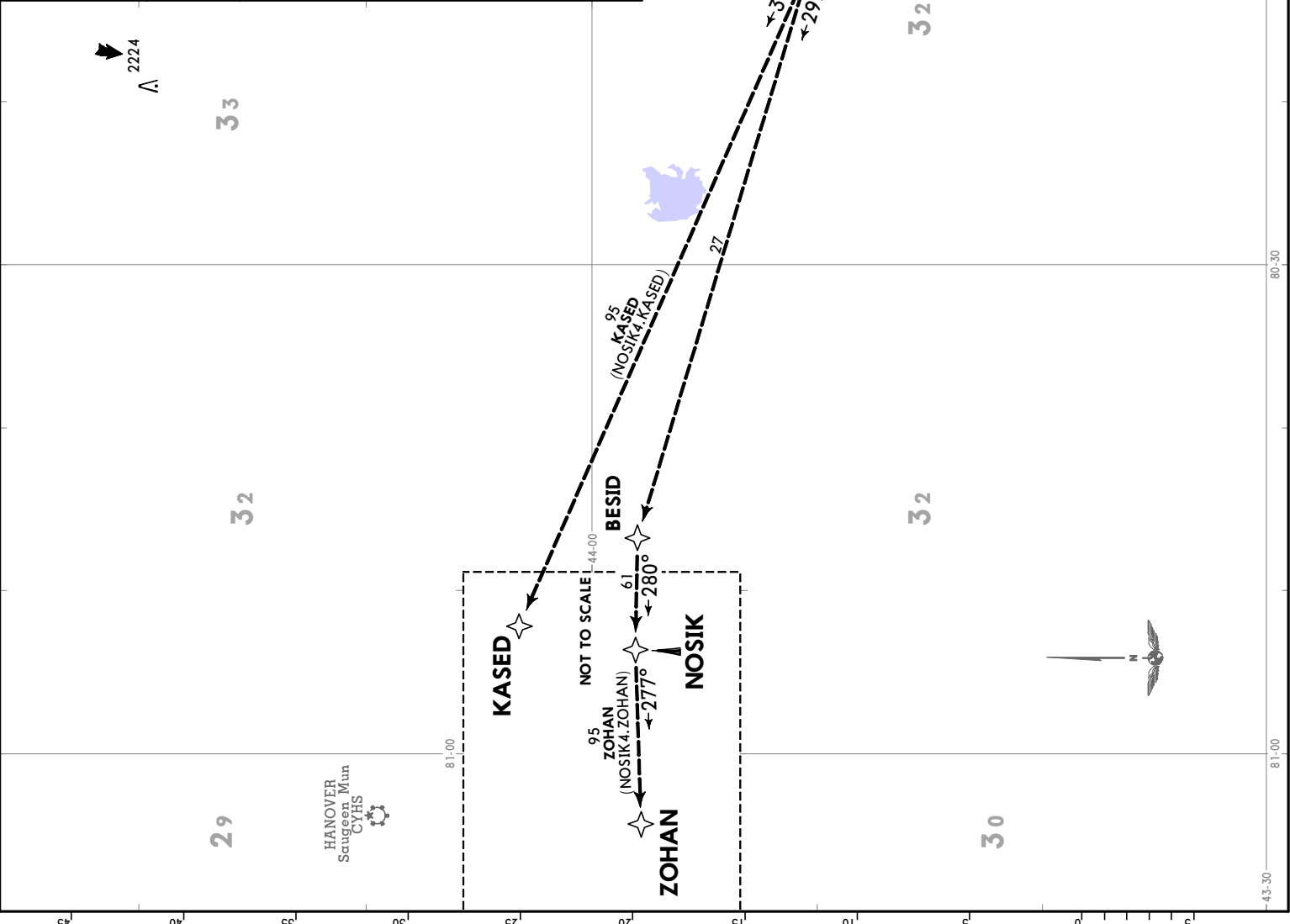

JEPPesen
 28 APR 23 (10-3Hz)
TORONTO, ONT
RNAV SID

TORONTO Departure
 128.8 127.575
 Apt Elev 569

Trans alt: 18000

1. RADAR required.
2. CAUTION: Rwys 05, 06L/R, 23, 24L/R departures: Simultaneous parallel departures in use.
3. Safe Altitude within 100 NM 4900.
4. Non-Jet aircraft only.
5. For use by GNSS equipped aircraft. GNSS aircraft with selectable CDI must be set to 1 NM sensitivity. Aircraft without selectable CDI must use flight director.
6. Refer to 10-4 Noise Abatement Procedures for additional requirements.

NUGOP 6 DEPARTURE (NUGOP6.)
 (RWYS 05, 06L/R, 23, 24L/R)

EDENVALE CNV8
 COLLINGWOOD CNY3
 STAYNER /Clearview CLV2
 A 2224

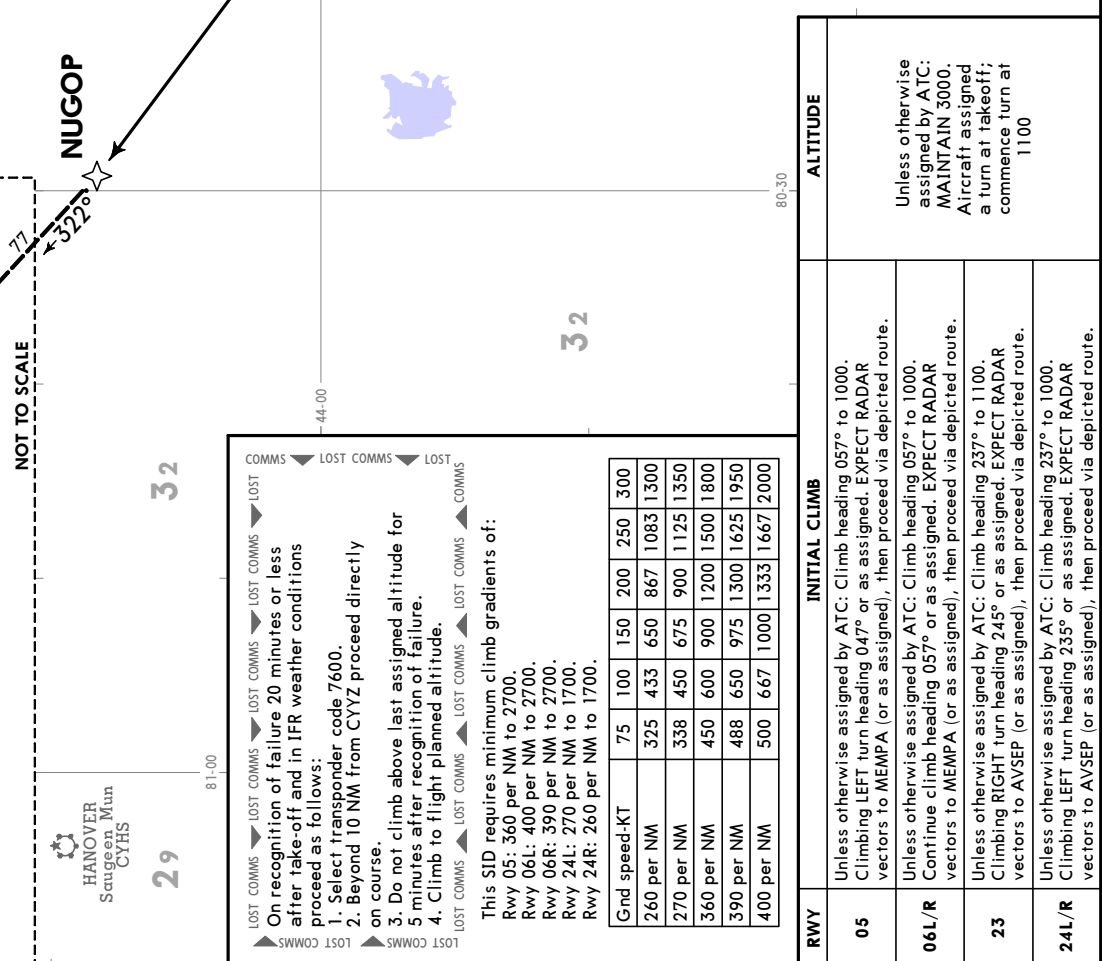
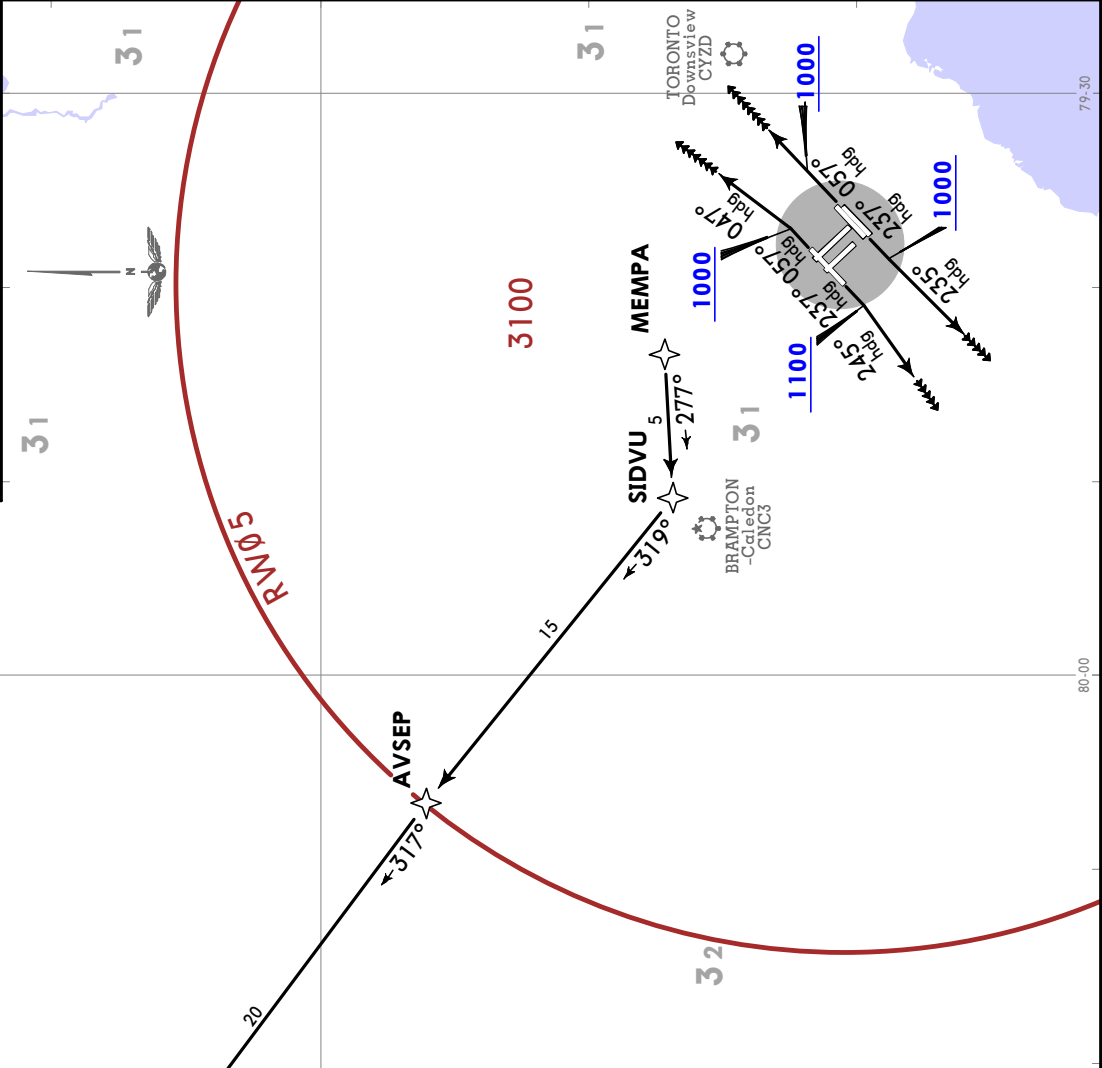
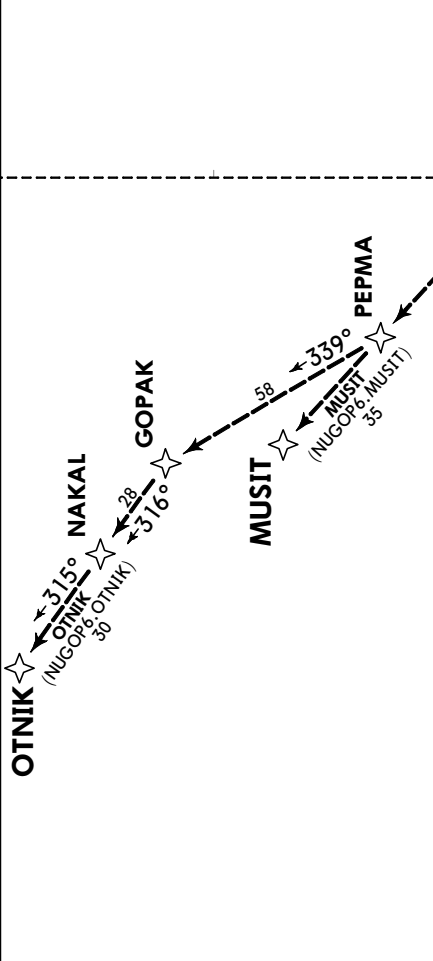

NOT TO SCALE

COMMS ▼ **LOST COMMS** ▼ **LOST**

On recognition of failure 20 minutes or less after take-off and in IFR weather conditions proceed as follows:

1. Select transponder code 7600.
2. Beyond 10 NM from CYYZ proceed directly on course.
3. Do not climb above last assigned altitude for 5 minutes after recognition of failure.
4. Climb to flight planned altitude.

LOST COMMS ▲ **LOST COMMS** ▲ **LOST COMMS** ▲ **COMMS**

This SID requires minimum climb gradients of:

Rwy 05: 360 per NM to 2700.
 Rwy 06L: 400 per NM to 2700.
 Rwy 06R: 390 per NM to 2700.
 Rwy 24L: 270 per NM to 1700.
 Rwy 24R: 260 per NM to 1700.

Gnd speed-KT	75	100	150	200	250	300
260 per NM	325	433	650	867	1083	1300
270 per NM	338	450	675	900	1125	1350
360 per NM	450	600	900	1200	1500	1800
390 per NM	488	650	975	1300	1625	1950
400 per NM	500	667	1000	1333	1667	2000

RWY	INITIAL CLIMB	ALTITUDE
05	Unless otherwise assigned by ATC: Climb heading 057° to 1000. Climbing LEFT turn heading 047° or as assigned. EXPECT RADAR vectors to MEMPA (or as assigned), then proceed via depicted route.	Unless otherwise assigned by ATC: MAINTAIN 3000. Aircraft assigned a turn at takeoff; commence turn at 1100
06L/R	Unless otherwise assigned by ATC: Climb heading 057° to 1000. Continue climb heading 057° or as assigned. EXPECT RADAR vectors to MEMPA (or as assigned), then proceed via depicted route.	
23	Unless otherwise assigned by ATC: Climb heading 237° to 1100. Climbing RIGHT turn heading 245° or as assigned. EXPECT RADAR vectors to AVSEP (or as assigned), then proceed via depicted route.	
24L/R	Unless otherwise assigned by ATC: Climb heading 237° to 1000. Climbing LEFT turn heading 235° or as assigned. EXPECT RADAR vectors to AVSEP (or as assigned), then proceed via depicted route.	

TORONTO, ONT
JEPPESEN
CYYZ/YYZ
LESTER B PEARSON INTL
RNAV SID
10-3H3
 28 APR 23

TORONTO
 Departure
128.8
127.575

Apt Elev
569

Trans alt: 18000
 1. RADAR required.
 2. Safe Altitude within 100 NM 4900.
 3. Non-Jet aircraft only.
 4. For use by GNSS equipped aircraft. GNSS aircraft with a selectable CDI must be set to 1 NM sensitivity. Aircraft without selectable CDI must use flight director.
 5. Refer to 10-4 Noise Abatement Procedures for additional requirements.

NUGOP 6 DEPARTURE (NUGOP6.)
(RWYS 15L/R, 33L/R)

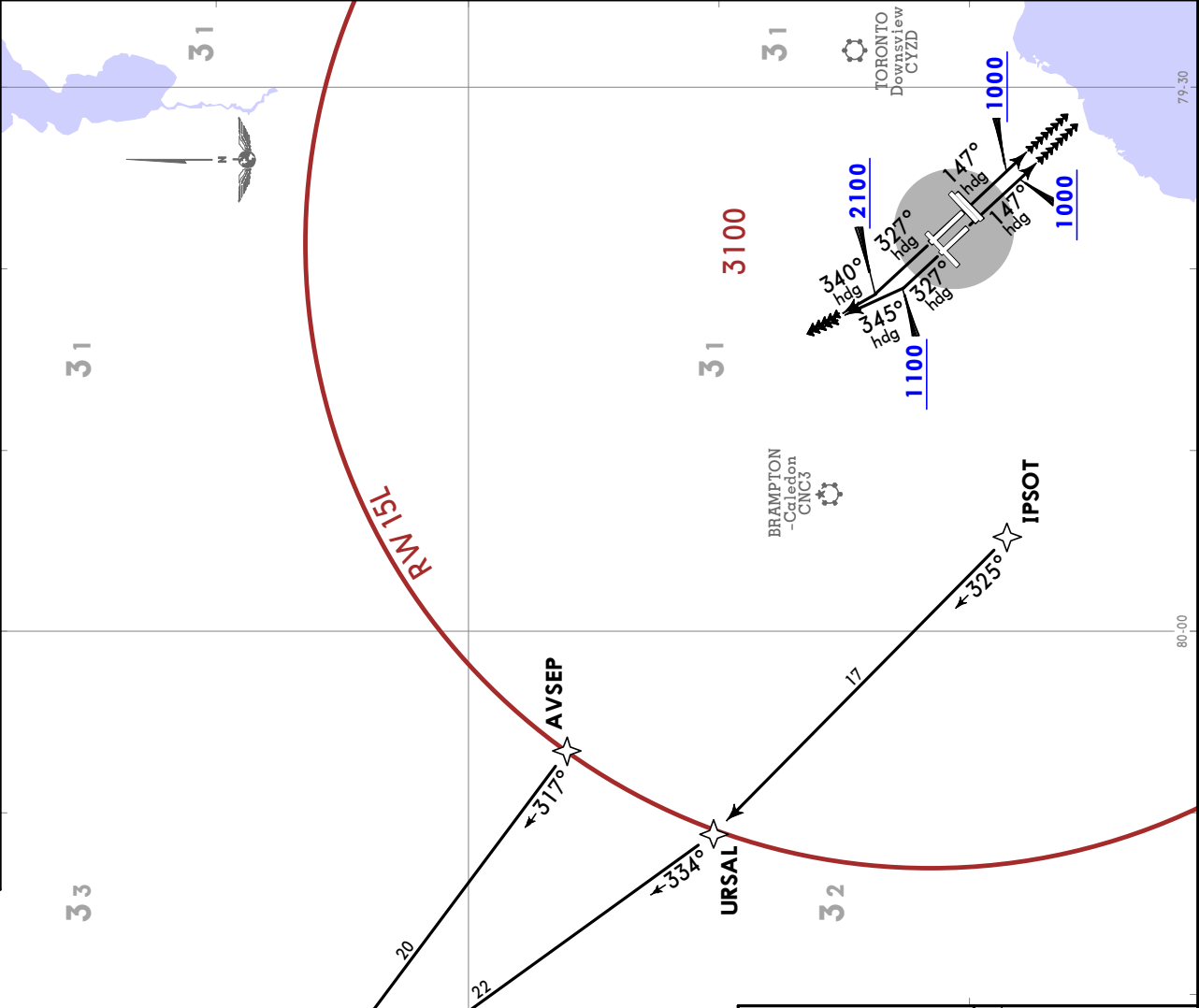

RWY	INITIAL CLIMB	ALTITUDE
15L/R	Unless otherwise assigned by ATC: Climb heading 147° to 1000. Continue climb heading 147° or as assigned. EXPECT RADAR vectors to IPSOT (or as assigned), then proceed via depicted route.	Unless otherwise assigned by ATC: MAINTAIN 3000. Aircraft assigned a turn at takeoff; commence turn at 1100
33L	Unless otherwise assigned by ATC: Climb heading 327° to 1100. Climbing RIGHT turn heading 345° or as assigned. EXPECT RADAR vectors to AVSEP (or as assigned), then proceed via depicted route.	
33R	Unless otherwise assigned by ATC: Climb heading 327° to 2100. Climbing RIGHT turn heading 340° or as assigned. EXPECT RADAR vectors to AVSEP (or as assigned), then proceed via depicted route.	

This SID requires minimum climb gradients of:
 Rwy 15L: 390 per NM to 3000.
 Rwy 15R: 380 per NM to 3000.
 Rwy 33L: 250 per NM to 900.

Gnd speed-KT	75	100	150	200	250	300
250 per NM	313	417	625	833	1042	1250
380 per NM	475	633	950	1267	1583	1900
390 per NM	488	650	975	1300	1625	1950

- On recognition of failure 20 minutes or less after take-off and in IFR weather conditions proceed as follows:
- Select transponder code 7600.
 - Beyond 10 NM from CYYZ proceed directly on course.
 - Do not climb above last assigned altitude for 5 minutes after recognition of failure.
 - Climb to flight planned altitude.

CHANGES: Airport name.

CYYZ/YYZ
LESTER B PEARSON INTL

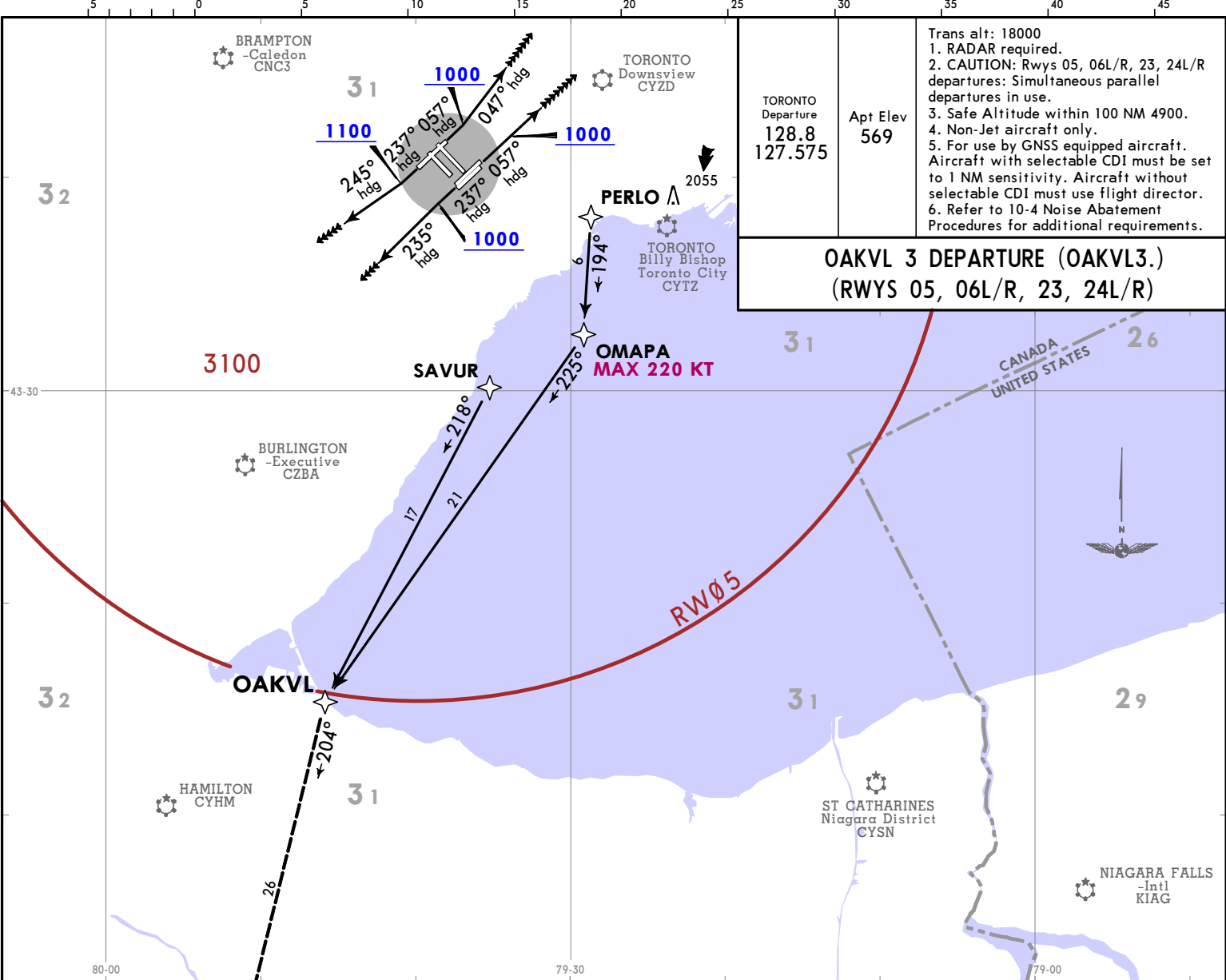

This SID requires minimum climb gradients of:

Rwy 05: 360 per NM to 2700.
Rwy 06L: 400 per NM to 2700.
Rwy 06R: 390 per NM to 2700.
Rwy 24L: 270 per NM to 1700.
Rwy 24R: 260 per NM to 1700.

Gnd speed-KT	75	100	150	200	250	300
260 per NM	325	433	650	867	1083	1300
270 per NM	338	450	675	900	1125	1350
360 per NM	450	600	900	1200	1500	1800
390 per NM	488	650	975	1300	1625	1950
400 per NM	500	667	1000	1333	1667	2000

- LOST COMMS ▼ LOST COMMS ▼ LOST COMMS ▼ LOST COMMS ▼ LOST COMMS ▼ LOST COMMS ▼
- On recognition of failure 20 minutes or less after take-off and in IFR weather conditions proceed as follows:
1. Select transponder code 7600.
 2. Beyond 10 NM from CYYZ proceed directly on course.
 3. Do not climb above last assigned altitude for 5 minutes after recognition of failure.
 4. Climb to flight planned altitude.
- LOST COMMS ▲ LOST COMMS ▲ LOST COMMS ▲ LOST COMMS ▲ LOST COMMS ▲ LOST COMMS ▲

RWY	INITIAL CLIMB	ALTITUDE
05	Unless otherwise assigned by ATC: Climb heading 057° to 1000. Climbing LEFT turn heading 047° or as assigned. EXPECT RADAR vectors to PERLO (or as assigned), then proceed via depicted route.	Unless otherwise assigned by ATC: MAINTAIN 3000. Aircraft assigned a turn at takeoff; commence turn at 1100.
06L/R	Unless otherwise assigned by ATC: Climb heading 057° to 1000. Continue climb heading 057° or as assigned. EXPECT RADAR vectors to PERLO (or as assigned), then proceed via depicted route.	
23	Unless otherwise assigned by ATC: Climb heading 237° to 1100. Climbing RIGHT turn heading 245° or as assigned. EXPECT RADAR vectors to SAVUR (or as assigned), then proceed via depicted route.	
24L/R	Unless otherwise assigned by ATC: Climb heading 237° to 1000. Climbing LEFT turn heading 235° or as assigned. EXPECT RADAR vectors to SAVUR (or as assigned), then proceed via depicted route.	

OAKVL 3 DEPARTURE (OAKVL3.)
(RWYS 05, 06L/R, 23, 24L/R)

28 APR 23 (10-3H4)
JEPPESSEN TORONTO, ONT
RNAV SID

CHANGES: Airport name.



TORONTO Departure 128.8 127.575	Trans alt: 18000 1. RADAR required. 2. Safe Altitude within 100 NM 4900. 3. Non-Jet aircraft only. 4. For use by GNSS equipped aircraft. GNSS aircraft with a selectable CDI must be set to 1 NM sensitivity. Aircraft without selectable CDI must use flight director. 5. Refer to 10-4 Noise Abatement Procedures for additional requirements.
Apt Elev 569	

OAKVL 3 DEPARTURE (OAKVL3.) (RWYS 15L/R, 33L/R)

LOST COMMS ▼ LOST COMMS ▼ LOST COMMS ▼ LOST COMMS ▼ LOST COMMS ▼ LOST COMMS ▼ LOST COMMS ▼ LOST COMMS ▼ LOST COMMS ▼

On recognition of failure 20 minutes or less after take-off and in IFR weather conditions proceed as follows:

1. Select transponder code 7600.
2. Beyond 10 NM from CYYZ proceed directly on course.
3. Do not climb above last assigned altitude for 5 minutes after recognition of failure.
4. Climb to flight planned altitude.

This SID requires minimum climb gradients of:

Rwy 15L: 390 per NM to 3000.
Rwy 15R: 380 per NM to 3000.
Rwy 33L: 250 per NM to 900.

Gnd speed-KT	75	100	150	200	250	300
250 per NM	313	417	625	833	1042	1250
380 per NM	475	633	950	1267	1583	1900
390 per NM	488	650	975	1300	1625	1950

RWY	INITIAL CLIMB	ALTITUDE
15L/R	Unless otherwise assigned by ATC: Climb heading 147° to 1000. Continue climb heading 147° or as assigned. EXPECT RADAR vectors to OAKVL (or as assigned), then proceed via depicted route.	Unless otherwise assigned by ATC: MAINTAIN 3000. Aircraft assigned a turn at takeoff; commence turn at 1100.
33L	Unless otherwise assigned by ATC: Climb heading 327° to 1100. Climbing RIGHT turn heading 345° or as assigned. EXPECT RADAR vectors to SERPI (or as assigned), then proceed via depicted route.	
33R	Unless otherwise assigned by ATC: Climb heading 327° to 2100. Climbing RIGHT turn heading 340° or as assigned. EXPECT RADAR vectors to SERPI (or as assigned), then proceed via depicted route.	

CYYZ/YYZ
LESTER B PEARSON INTL

28 APR 23
JEPPESSEN
10-345

TORONTO, ONT
RNAV SID

OAKVL 3 DEPARTURE (OAKVL3.) (RWYS 15L/R, 33L/R)

JEPPESEN TORONTO, ONT
RNAV SID

28 APR 23 10-3J

PEMBA 6 DEPARTURE (PEMBA6.)
(RWYS 05, 06L/R, 23, 24L/R)

Trans alt: 18000
1. RADAR required.
2. CAUTION: Rwys 05, 06L/R, 23, 24L/R departures: Simultaneous parallel departures in use.
3. Safe Altitude within 100 NM 4900.

4. Non-Jet aircraft only.
5. For use by GNSS equipped aircraft. GNSS aircraft with selectable CDI must be set to 1 NM sensitivity. Aircraft without selectable CDI must use flight director.
6. Refer to 10-4 Noise Abatement Procedures for additional requirements.

APR 23 10-3J

TORONTO Departure
128.8 127.575

Apt Elev
569

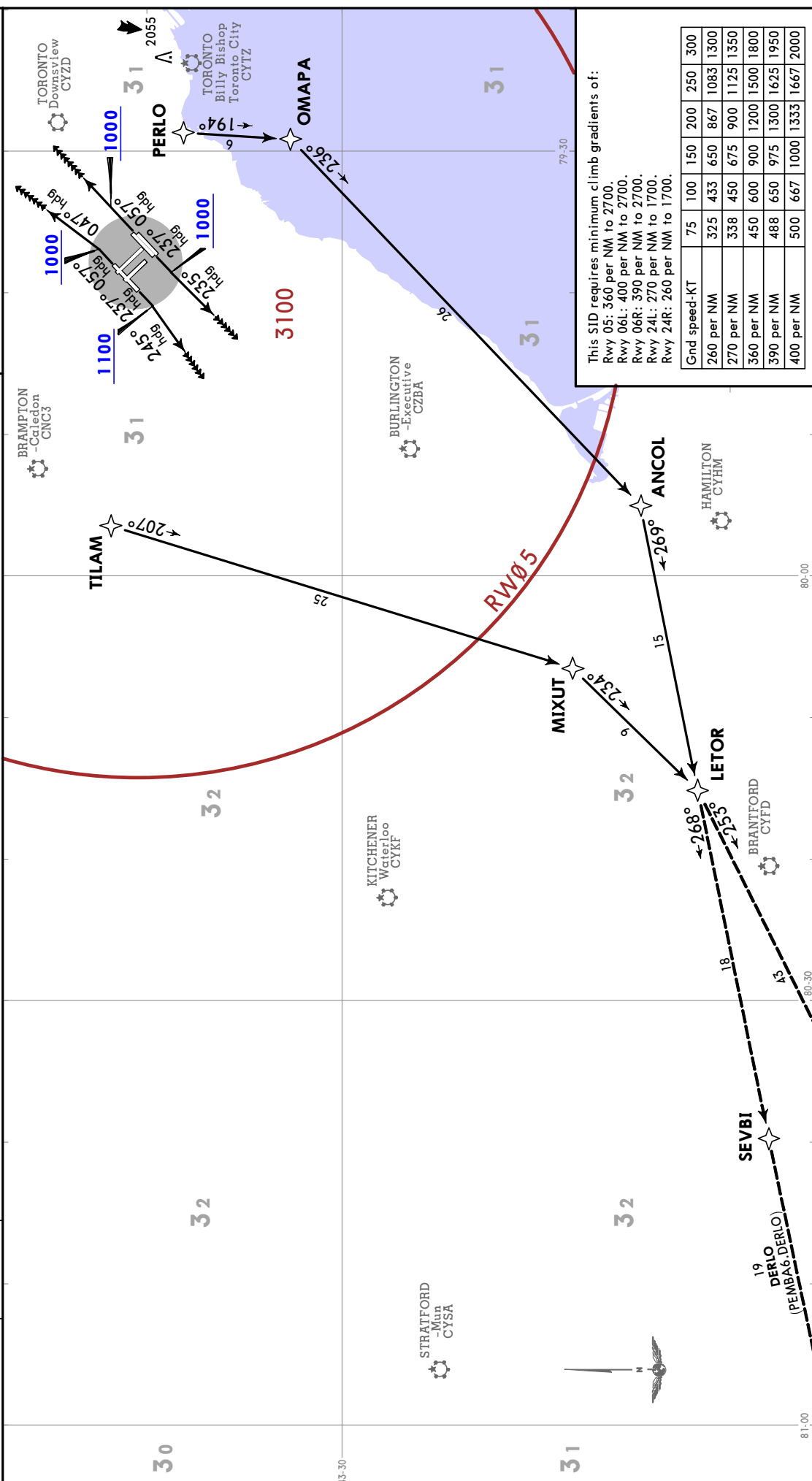

This SID requires minimum climb gradients of:

Rwy 05: 360 per NM to 2700.
 Rwy 06L: 400 per NM to 2700.
 Rwy 06R: 390 per NM to 2700.
 Rwy 24L: 270 per NM to 1700.
 Rwy 24R: 260 per NM to 1700.

Gnd speed-KT	75	100	150	200	250	300
260 per NM	325	433	650	867	1083	1300
270 per NM	338	450	675	900	1125	1350
360 per NM	450	600	900	1200	1500	1800
390 per NM	488	650	975	1300	1625	1950
400 per NM	500	667	1000	1333	1667	2000

RWY	INITIAL CLIMB	ALTITUDE
05	Unless otherwise assigned by ATC: Climb heading 057° to 1000. Climbing LEFT turn heading 047° or as assigned. EXPECT RADAR vectors to PERLO (or as assigned), then proceed via depicted route.	Unless otherwise assigned by ATC: MAINTAIN 3000. Aircraft assigned a turn at takeoff; commence turn at 1100
06L/R	Unless otherwise assigned by ATC: Climb heading 057° to 1000. Continue climb heading 057° or as assigned. EXPECT RADAR vectors to PERLO (or as assigned), then proceed via depicted route.	
23	Unless otherwise assigned by ATC: Climb heading 237° to 1100. Climbing RIGHT turn heading 245° or as assigned. EXPECT RADAR vectors to TILAM (or as assigned), then proceed via depicted route.	
24L/R	Unless otherwise assigned by ATC: Climb heading 237° to 1000. Climbing LEFT turn heading 235° or as assigned. EXPECT RADAR vectors to TILAM (or as assigned), then proceed via depicted route.	

LOST COMMS
LOST COMMS
LOST COMMS
LOST COMMS
LOST COMMS

COMMS
LOST COMMS
LOST COMMS
LOST COMMS
LOST COMMS

On recognition of failure 20 minutes or less after take-off and in IFR weather conditions proceed as follows:
 1. Select transponder code 7600.
 2. Beyond 10 NM from CYYZ proceed directly on course.
 3. Do not climb above last assigned altitude for 5 minutes after recognition of failure.
 4. Climb to flight planned altitude.

JEPPESSEN
 28 APR 23 (10-3J1)
CYZZ/YYZ
 LESTER B PEARSON INTL

TORONTO, ONT
RNAV SID

PEMBA 6 DEPARTURE (PEMBA6.)
 (RWYS 15L/R, 33L/R)

4. For use by GNSSE equipped aircraft. GNSSE aircraft with selectable CDI must be set to 1 NM sensitivity. Aircraft without selectable CDI must use flight director.
 5. Refer to 10-4 Noise Abatement Procedures for additional requirements.

Trans alt: 18000
 1. RADAR required.
 2. Safe Altitude within 100 NM 4900.
 3. Non-Jet aircraft only.

Apt Elev
 569

TORONTO Departure
 128.8 127.575

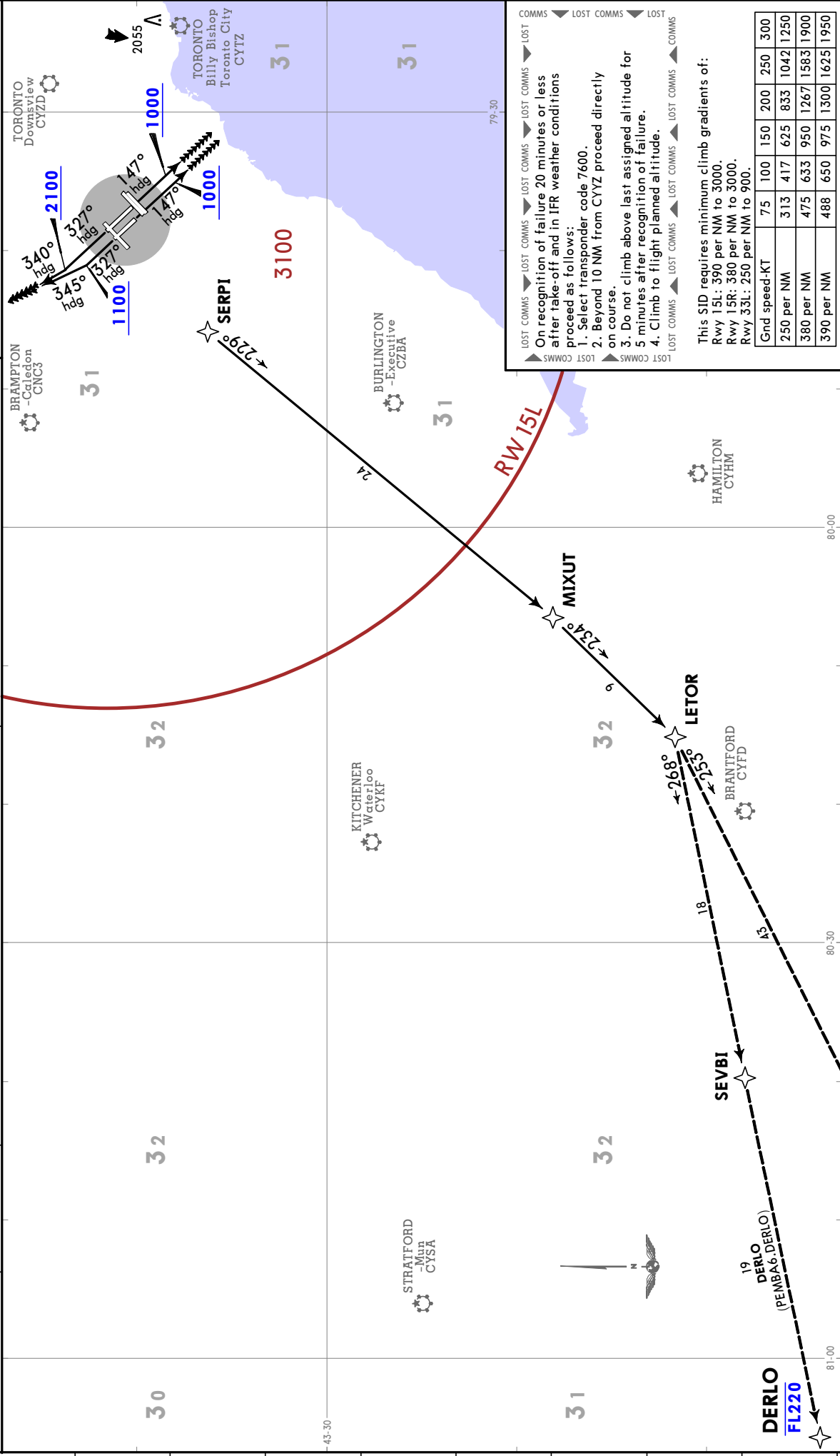

RWY	INITIAL CLIMB	ALTITUDE
15L/R	Unless otherwise assigned by ATC: Climb heading 147° to 1000. Continue climb heading 147° or as assigned. EXPECT RADAR vectors to MIXUT (or as assigned), then proceed via depicted route.	1000
33L	Unless otherwise assigned by ATC: Climb heading 327° to 1100. Climbing RIGHT turn heading 345° or as assigned. EXPECT RADAR vectors to SERPI (or as assigned), then proceed via depicted route.	1100
33R	Unless otherwise assigned by ATC: Climb heading 327° to 2100. Climbing RIGHT turn heading 340° or as assigned. EXPECT RADAR vectors to SERPI (or as assigned), then proceed via depicted route.	2100

Trans alt: 18000
 1. RADAR required.
 2. CAUTION: Rwy 05, 06L/R, 23, 24L/R departures: Simultaneous parallel departures in use. 3. Safe Altitude within 100 NM 4900. 4. Non-jet aircraft only. 5. For use by GNSS equipped aircraft. GNSS aircraft with selectable CDI must be set to 1 NM sensitivity. Aircraft without selectable CDI must use flight director. 6 Refer to 10-4 Noise Abatement Procedures for additional requirements.

TORONTO Departure
 128.8
 127.575

Apt Elev
 569

PERLO 5 DEPARTURE (PERLO5.)
(RWYS 05, 06L/R, 23, 24L/R)

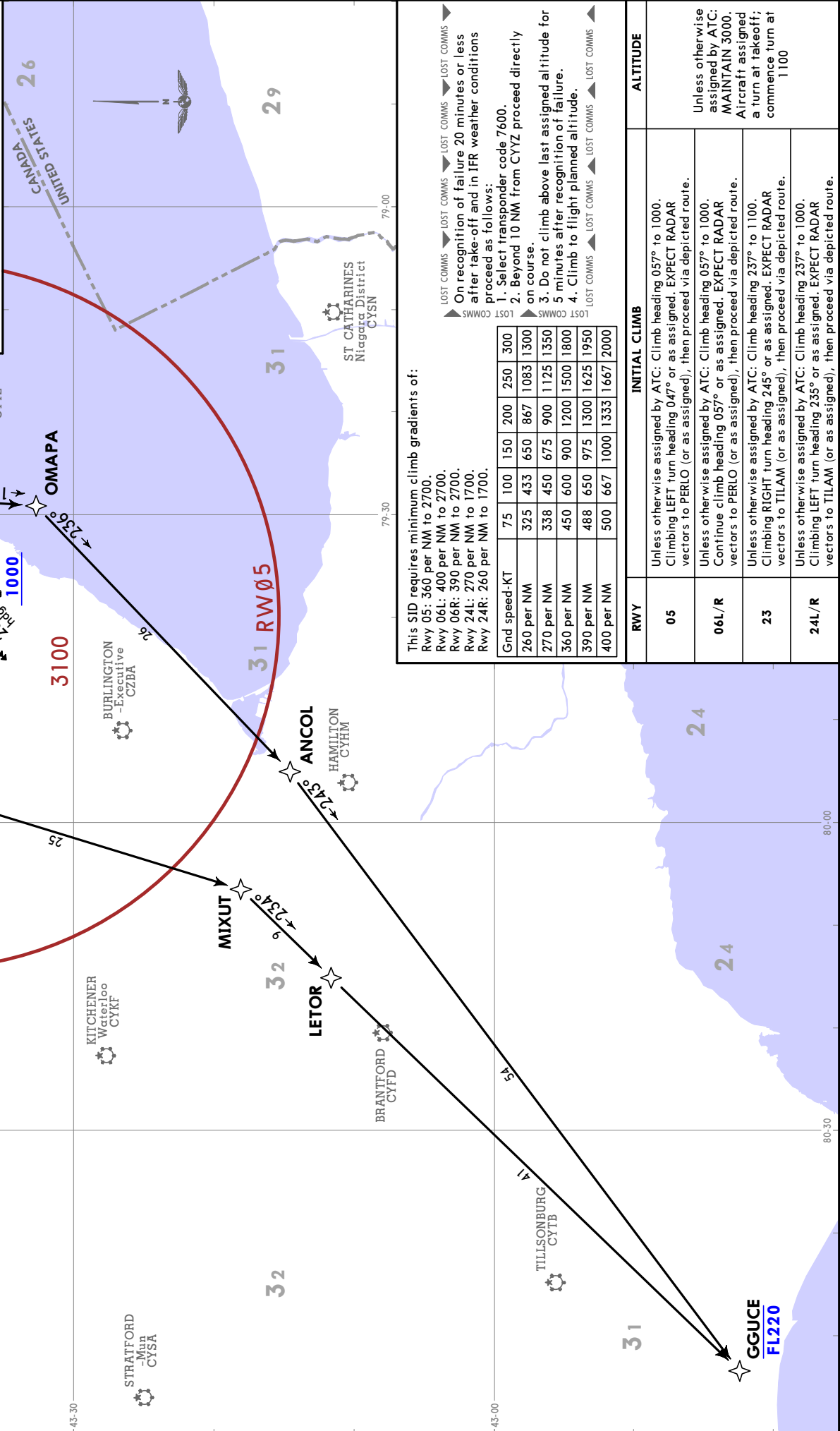

CHANGES: Airport name.

CYYZ/YYZ
LESTER B PEARSON INTL

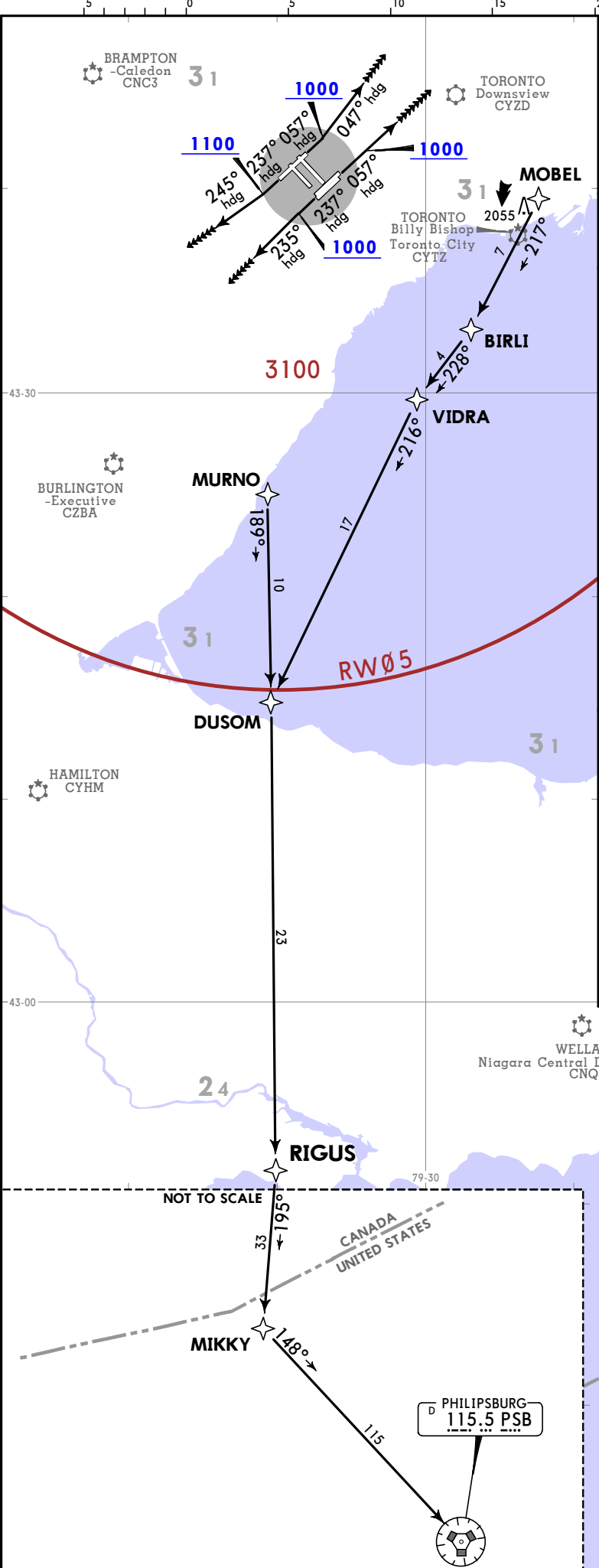

TORONTO Departure 128.8 127.575	Apt Elev 569	Trans alt: 18000 1. RADAR required. 2. CAUTION: Rwy 05, 06L/R, 23, 24L/R departures: Simultaneous parallel departures in use. 3. Safe Altitude within 100 NM 4900. 4. Jet aircraft only. 5. For use by GNSS or D/D/I equipped aircraft. Aircraft with selectable CDI must be set to 1 NM sensitivity. Aircraft without selectable CDI must use flight director. 6. Refer to 10-4 Noise Abatement Procedures for additional requirements.
---------------------------------------	-----------------	--

RIGUS 5 DEPARTURE (RIGUS5.) (RWYS 05, 06L/R, 23, 24L/R)

LOST COMMS
On recognition of failure 20 minutes or less after take-off and in IFR weather conditions proceed as follows:
1. Select transponder code 7600.
2. Beyond 10 NM from CYYZ proceed directly on course.
3. Do not climb above last assigned altitude for 5 minutes after recognition of failure.
4. Climb to flight planned altitude.

This SID requires minimum climb gradients of:
Rwy 05: 360 per NM to 2700.
Rwy 06L: 400 per NM to 2700.
Rwy 06R: 390 per NM to 2700.
Rwy 24L: 270 per NM to 1700.
Rwy 24R: 260 per NM to 1700.

Gnd speed-KT	75	100	150	200	250	300
260 per NM	325	433	650	867	1083	1300
270 per NM	338	450	675	900	1125	1350
360 per NM	450	600	900	1200	1500	1800
390 per NM	488	650	975	1300	1625	1950
400 per NM	500	667	1000	1333	1667	2000

RWY	INITIAL CLIMB	ALTITUDE
05	Unless otherwise assigned by ATC: Climb heading 057° to 1000. Climbing LEFT turn heading 047° or as assigned. EXPECT RADAR vectors to MOBEL (or as assigned), then proceed via depicted route.	Unless otherwise assigned by ATC: MAINTAIN 5000
06L/R	Unless otherwise assigned by ATC: Climb heading 057° to 1000. Continue climb heading 057° or as assigned. EXPECT RADAR vectors to MOBEL (or as assigned), then proceed via depicted route.	
23	Unless otherwise assigned by ATC: Climb heading 237° to 1100. Climbing RIGHT turn heading 245° or as assigned. EXPECT RADAR vectors to MURNO (or as assigned), then proceed via depicted route.	
24L/R	Unless otherwise assigned by ATC: Climb heading 237° to 1000. Climbing LEFT turn heading 235° or as assigned. EXPECT RADAR vectors to MURNO (or as assigned), then proceed via depicted route.	

RIGUS 5 DEPARTURE (RIGUS5.)
(RWYS 05, 06L/R, 23, 24L/R)

JEPPESSEN TORONTO, ONT
RNAV SID
28 Apr 23 10-3K

CHANGES: Airport name.

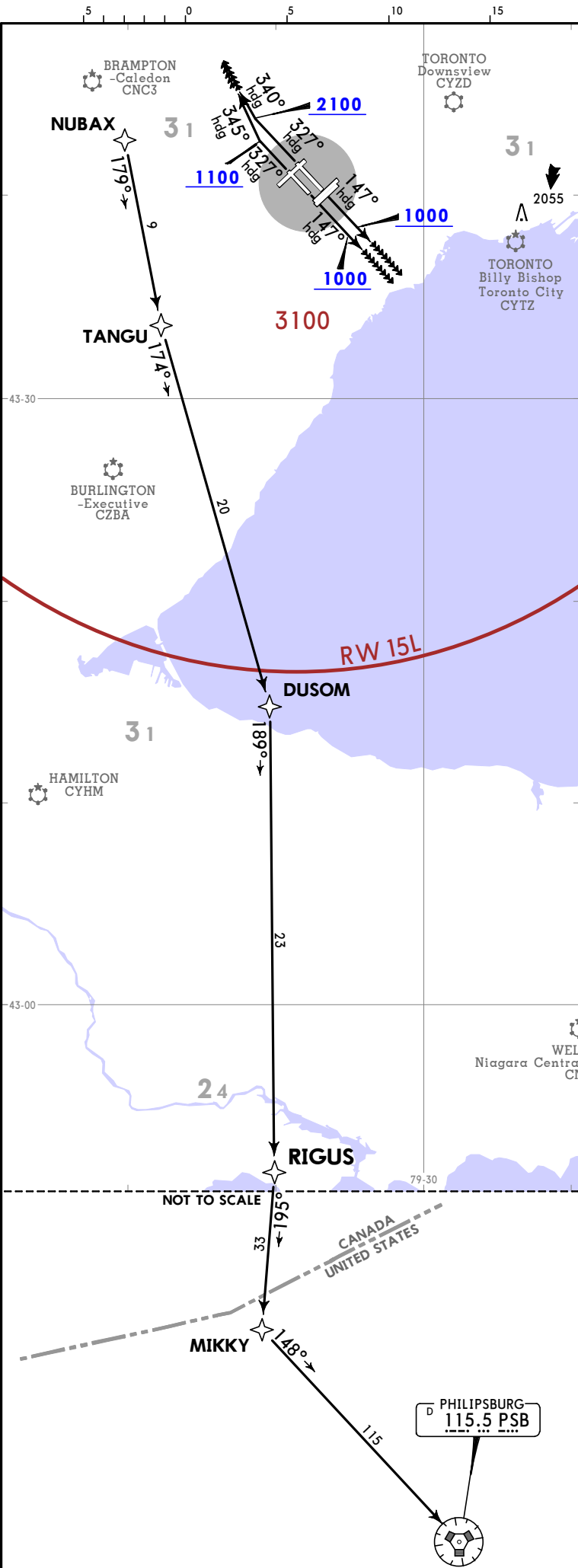

TORONTO Departure 128.8 127.575	Apt Elev 569	Trans alt: 18000 1. RADAR required. 2. Safe Altitude within 100 NM 4900. 3. Jet aircraft only. 4. For use by GNSS or D/D/I equipped aircraft. Aircraft with selectable CDI must be set to 1 NM sensitivity. Aircraft without selectable CDI must use flight director. 5. Refer to 10-4 Noise Abatement Procedures for additional requirements.
--	------------------------	---

**RIGUS 5 DEPARTURE (RIGUS5.)
(RWYS 15L/R, 33L/R)**

LOST COMMS ▼ LOST COMMS ▼ LOST COMMS ▼ LOST COMMS ▼ LOST COMMS
 ▲ LOST COMMS ▲ LOST COMMS ▲ LOST COMMS ▲ LOST COMMS ▲ LOST COMMS

On recognition of failure 20 minutes or less after take-off and in IFR weather conditions proceed as follows:

1. Select transponder code 7600.
2. Beyond 10 NM from CYYZ proceed directly on course.
3. Do not climb above last assigned altitude for 5 minutes after recognition of failure.
4. Climb to flight planned altitude.

This SID requires minimum climb gradients of:

Rwy 15L: 390 per NM to 3000.						
Rwy 15R: 380 per NM to 3000.						
Rwy 33L: 250 per NM to 900.						
Gnd speed-KT	75	100	150	200	250	300
250 per NM	313	417	625	833	1042	1250
380 per NM	475	633	950	1267	1583	1900
390 per NM	488	650	975	1300	1625	1950

RWY	INITIAL CLIMB	ALTITUDE
15L/R	Unless otherwise assigned by ATC: Climb heading 147° to 1000. Continue climb heading 147° or as assigned. EXPECT RADAR vectors to DUSOM (or as assigned), then proceed via depicted route.	Unless otherwise assigned by ATC: MAINTAIN 5000
33L	Unless otherwise assigned by ATC: Climb heading 327° to 1100. Climbing RIGHT turn heading 345° or as assigned. EXPECT RADAR vectors to NUBAX (or as assigned), then proceed via depicted route.	
33R	Unless otherwise assigned by ATC: Climb heading 327° to 2100. Climbing RIGHT turn heading 340° or as assigned. EXPECT RADAR vectors to NUBAX (or as assigned), then proceed via depicted route.	

CYYZ/YYZ
LESTER B PEARSON INTL

JEPPESSEN
28 APR 23
(10-3K1)

TORONTO, ONT
RNAV SID

**RIGUS 5 DEPARTURE (RIGUS5.)
(RWYS 15L/R, 33L/R)**

CHANGES: Airport name.

CYYZ/YYZ
LESTER B PEARSON INTL

TORONTO Departure 128.8 127.575	Apt Elev 569	Trans alt: 18000 1. RADAR required. 2. CAUTION: Rwsy 05, 06L/R, 23, 24L/R departures: Simultaneous parallel departures in use. 3. Safe Altitude within 100 NM 4900. 4. Jet aircraft only. 5. For use by GNSS or D/D/I equipped aircraft. Aircraft with selectable CDI must be set to 1 NM sensitivity. Aircraft without selectable CDI must use flight director. 6. Refer to 10-4 Noise Abatement Procedures for additional requirements.
--	------------------------	---

SEDOG 6 DEPARTURE (SEDOG6.) (RWYS 05, 06L/R, 23, 24L/R)

LOST COMMS ▼ LOST COMMS ▼ LOST COMMS ▼ LOST COMMS ▼ LOST COMMS ▼

On recognition of failure 20 minutes or less after take-off and in IFR weather conditions proceed as follows:

1. Select transponder code 7600.
2. Beyond 10 NM from CYYZ proceed directly on course.
3. Do not climb above last assigned altitude for 5 minutes after recognition of failure.
4. Climb to flight planned altitude.

LOST COMMS ▲ LOST COMMS ▲ LOST COMMS ▲ LOST COMMS ▲ LOST COMMS ▲

This SID requires minimum climb gradients of:

Rwy 05: 360 per NM to 2700.
 Rwy 06L: 400 per NM to 2700.
 Rwy 06R: 390 per NM to 2700.
 Rwy 24L: 270 per NM to 1700.
 Rwy 24R: 260 per NM to 1700.

Gnd speed-KT	75	100	150	200	250	300
260 per NM	325	433	650	867	1083	1300
270 per NM	338	450	675	900	1125	1350
360 per NM	450	600	900	1200	1500	1800
390 per NM	488	650	975	1300	1625	1950
400 per NM	500	667	1000	1333	1667	2000

RWY	INITIAL CLIMB	ALTITUDE
05	Unless otherwise assigned by ATC: Climb heading 057° to 1000. Climbing LEFT turn heading 047° or as assigned. EXPECT RADAR vectors to GOTIM (or as assigned), then proceed via depicted route.	Unless otherwise assigned by ATC: MAINTAIN 5000
06L/R	Unless otherwise assigned by ATC: Climb heading 057° to 1000. Continue climb heading 057° or as assigned. EXPECT RADAR vectors to GOTIM (or as assigned), then proceed via depicted route.	
23	Unless otherwise assigned by ATC: Climb heading 237° to 1100. Climbing RIGHT turn heading 245° or as assigned. EXPECT RADAR vectors to BISTI (or as assigned), then proceed via depicted route.	
24L/R	Unless otherwise assigned by ATC: Climb heading 237° to 1000. Climbing LEFT turn heading 235° or as assigned. EXPECT RADAR vectors to BISTI (or as assigned), then proceed via depicted route.	

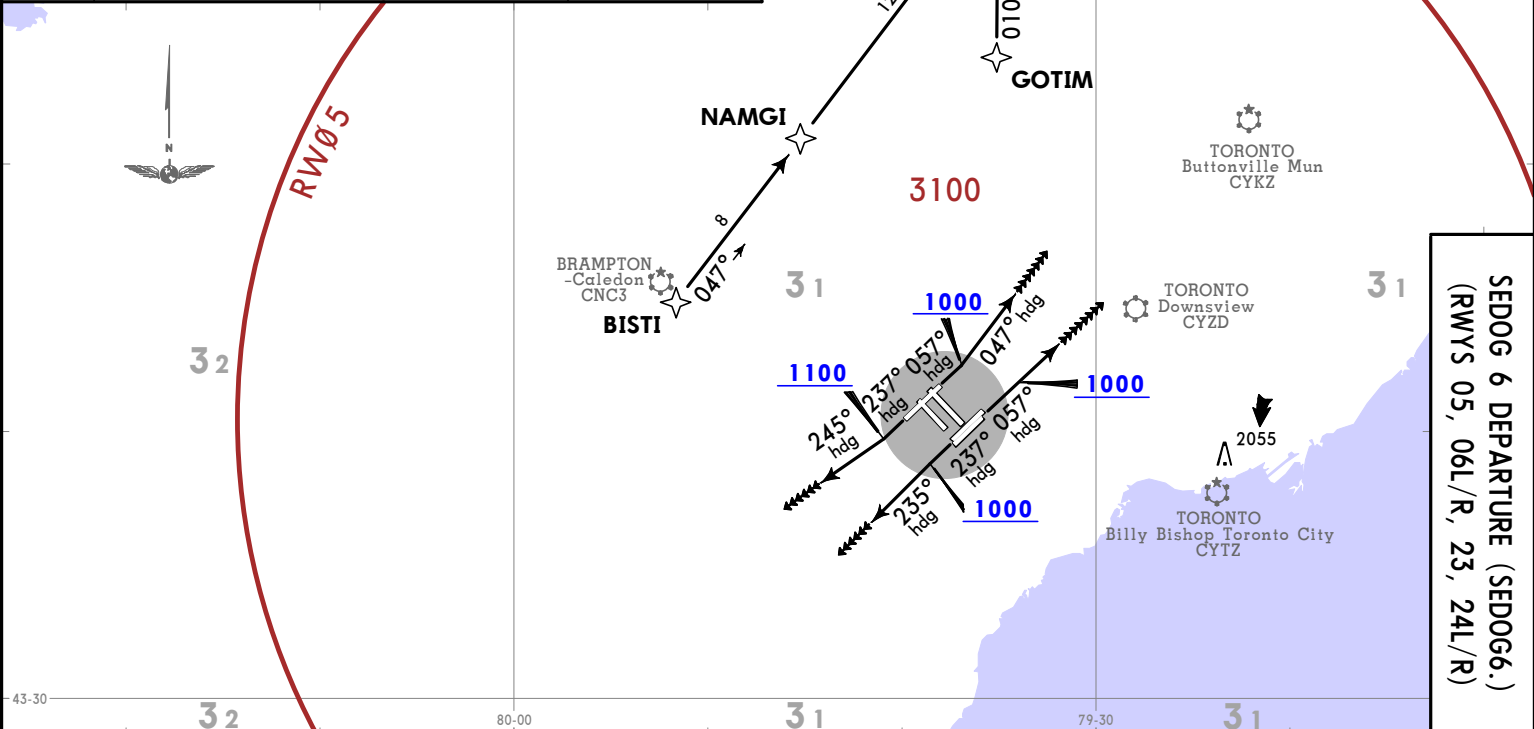

**SEDOG 6 DEPARTURE (SEDOG6.)
(RWYS 05, 06L/R, 23, 24L/R)**

28 APR 23 (10-31)
JEPPESSEN TORONTO, ONT
RNAV SID

© JEPPESSEN, 2018, 2023. ALL RIGHTS RESERVED.

CHANGES: Airport name.

TORONTO Departure
128.8
127.575

Apt Elev
569

Trans alt: 18000
1. RADAR required.
2. Safe Altitude within 100 NM 4900.
3. Jet aircraft only.
4. For use by GNSS or D/D/I equipped aircraft. Aircraft with selectable CDI must be set to 1 NM sensitivity. Aircraft without selectable CDI must use flight director.
5. Refer to 10-4 Noise Abatement Procedures for additional requirements.

SEDOG 6 DEPARTURE (SEDOG6.) (RWYS 15L/R, 33L/R)

LOST COMMS ▼ LOST COMMS ▼ LOST COMMS ▼ LOST COMMS ▼ LOST COMMS
On recognition of failure 20 minutes or less after take-off and in IFR weather conditions proceed as follows:
1. Select transponder code 7600.
2. Beyond 10 NM from CYYZ proceed directly on course.
3. Do not climb above last assigned altitude for 5 minutes after recognition of failure.
4. Climb to flight planned altitude.
LOST COMMS ▲ LOST COMMS ▲ LOST COMMS ▲ LOST COMMS ▲ COMMS

This SID requires minimum climb gradients of:
Rwy 15L: 390 per NM to 3000.
Rwy 15R: 380 per NM to 3000.
Rwy 33L: 250 per NM to 900.

Gnd speed-KT	75	100	150	200	250	300
250 per NM	313	417	625	833	1042	1250
380 per NM	475	633	950	1267	1583	1900
390 per NM	488	650	975	1300	1625	1950

RWY	INITIAL CLIMB	ALTITUDE
15L/R	Unless otherwise assigned by ATC: Climb heading 147° to 1000. Continue climb heading 147° or as assigned. EXPECT RADAR vectors to BORUX (or as assigned), then proceed via depicted route.	Unless otherwise assigned by ATC: MAINTAIN 5000
33L	Unless otherwise assigned by ATC: Climb heading 327° to 1100. Climbing RIGHT turn heading 345° or as assigned. EXPECT RADAR vectors to SEDOG (or as assigned), then proceed via depicted route.	
33R	Unless otherwise assigned by ATC: Climb heading 327° to 2100. Climbing RIGHT turn heading 340° or as assigned. EXPECT RADAR vectors to SEDOG (or as assigned), then proceed via depicted route.	

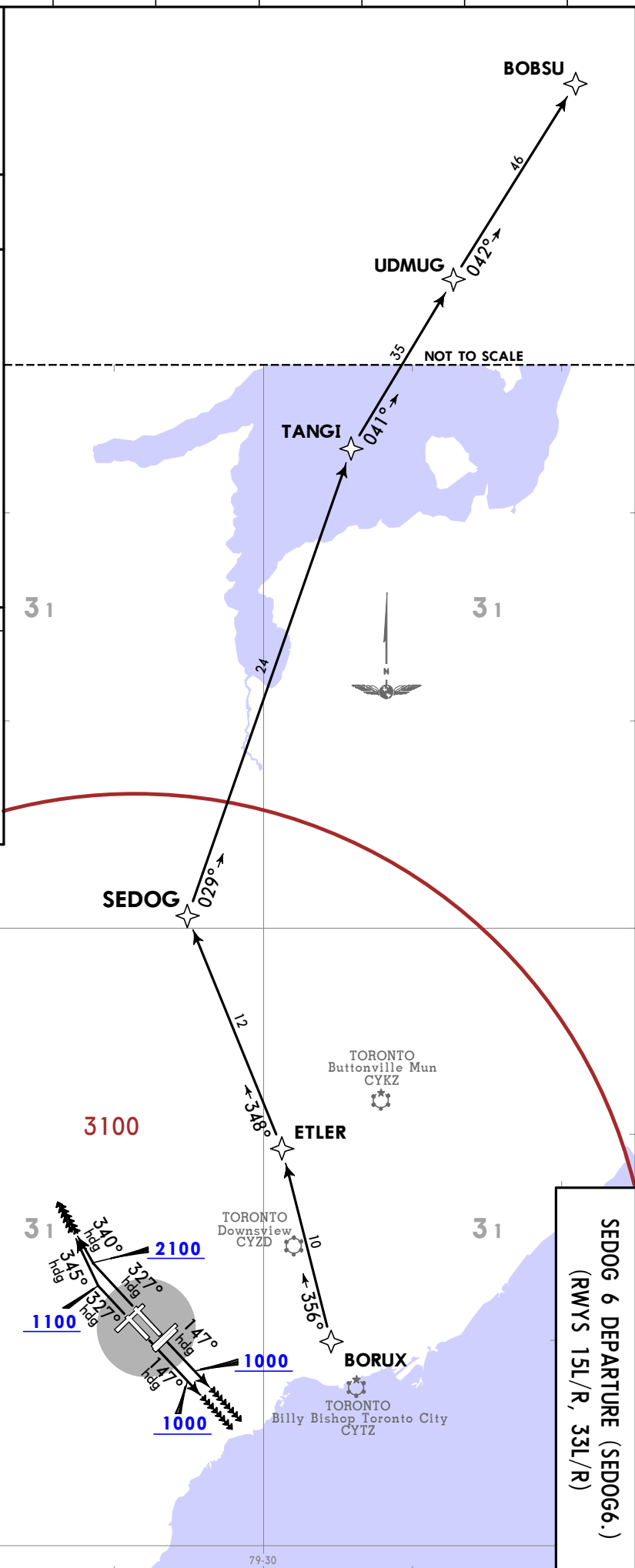

CYYZ/YYZ
 LESTER B PEARSON INTL
 28 APR 23
 JEPPESSEN
 (10-3M)
 TORONTO, ONT
 RNAV SID

© JEPPESSEN, 2018, 2023. ALL RIGHTS RESERVED.

TEVAD 3 DEPARTURE (TEVAD3.)
 (RWYS 05, 06L/R, 23, 24L/R)

4. Non-Jet aircraft only.
 5. For use by GNSS equipped aircraft. GNSS aircraft with selectable CDI must be set to 1 NM sensitivity. Aircraft without selectable CDI must use flight director.
 6. Refer to 10-4 Noise Abatement Procedures for additional requirements.

Trans alt: 18000
 1. RADAR required.
 2. CAUTION: Rwys 05, 06L/R, 23, 24L/R departures: Simultaneous parallel departures in use.
 3. Safe Altitude within 100 NM 4900.

TORONTO Departure
 128.8 127.575
 Apt Elev
 569

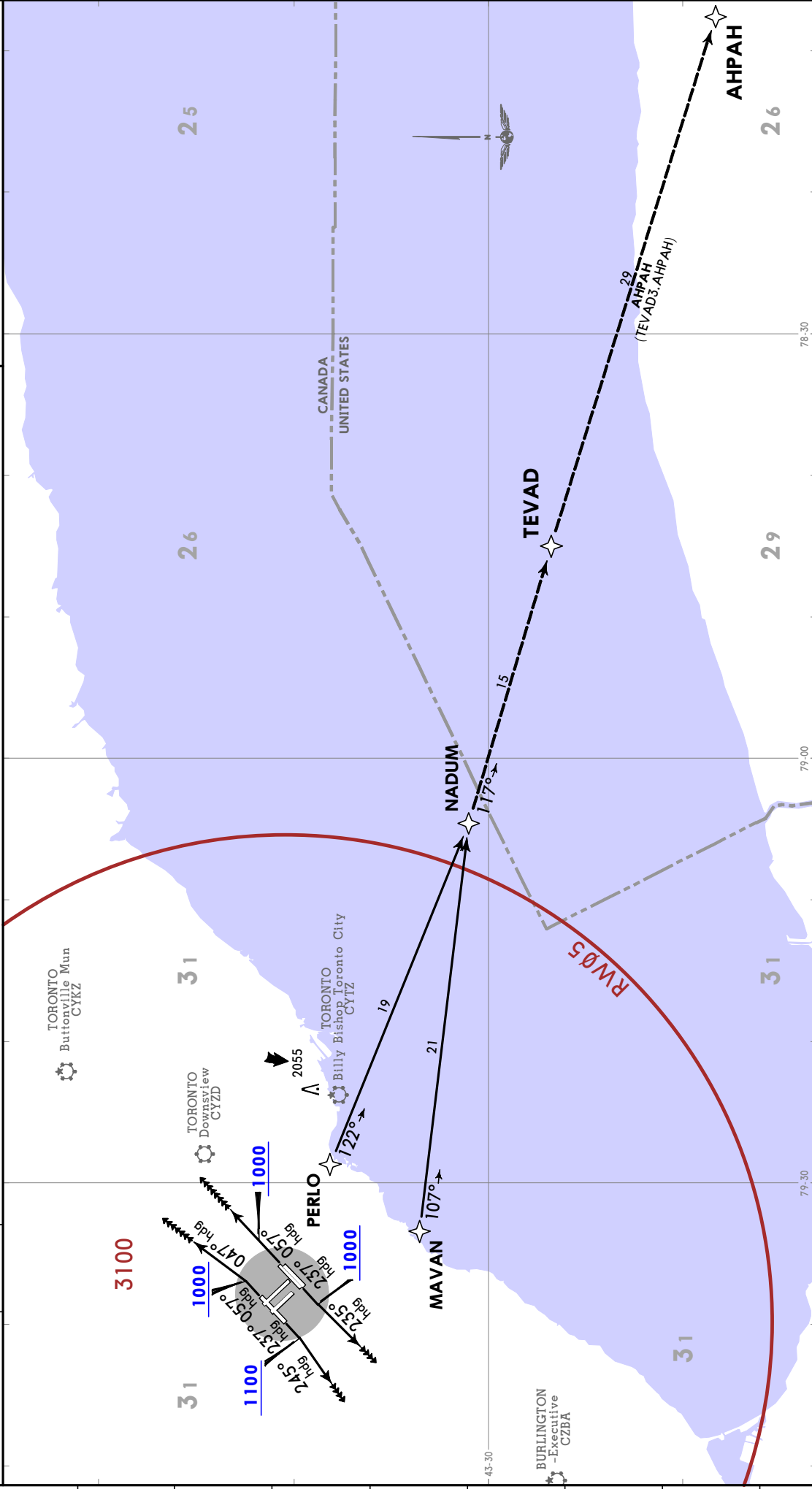

RWY	INITIAL CLIMB	ALTITUDE
05	Unless otherwise assigned by ATC: Climb heading 057° to 1000. Climbing LEFT turn heading 047° or as assigned. EXPECT RADAR vectors to PERLO (or as assigned), then proceed via depicted route.	Unless otherwise assigned by ATC: MAINTAIN 3000. Aircraft assigned a turn at takeoff; commence turn at 1100
06L/R	Unless otherwise assigned by ATC: Climb heading 057° to 1000. Continue climb heading 057° or as assigned. EXPECT RADAR vectors to PERLO (or as assigned), then proceed via depicted route.	
23	Unless otherwise assigned by ATC: Climb heading 237° to 1100. Climbing RIGHT turn heading 245° or as assigned. EXPECT RADAR vectors to MAVAN (or as assigned), then proceed via depicted route.	
24L/R	Unless otherwise assigned by ATC: Climb heading 237° to 1000. Climbing LEFT turn heading 235° or as assigned. EXPECT RADAR vectors to MAVAN (or as assigned), then proceed via depicted route.	

COMMS ▼ LOST COMMS ▼ LOST
 On recognition of failure 20 minutes or less after take-off and in IFR weather conditions proceed as follows:
 1. Select transponder code 7600.
 2. Beyond 10 NM from CYYZ proceed directly on course.
 3. Do not climb above last assigned altitude for 5 minutes after recognition of failure.
 4. Climb to flight planned altitude.
 LOST COMMS ▲ LOST COMMS ▲ LOST COMMS ▲ LOST COMMS ▲ LOST COMMS ▲ LOST

This SID requires minimum climb gradients of:

Rwy 05: 360 per NM to 2700.	Rwy 06L: 400 per NM to 2700.	Rwy 06R: 390 per NM to 2700.	Rwy 24L: 270 per NM to 1700.	Rwy 24R: 260 per NM to 1700.	
75	100	150	200	250	300
325	433	650	867	1083	1300
270 per NM	338	450	675	900	1125
360 per NM	450	600	900	1200	1500
390 per NM	488	650	975	1300	1625
400 per NM	500	667	1000	1333	1667
					2000

CHANGES: Airport name.

JEPPESEN
 28 APR 23 10-3P
RNAV SID

TORONTO, ONT
CYZZ/YYZ
 LESTER B PEARSON INTL

TEVAD 3 DEPARTURE (TEVAD3.)
 (RWYS 15L/R, 33L/R)

Trans alt: 18000
 1. RADAR required.
 2. Safe Altitude within 100 NM 4900.
 3. Non-Jet aircraft only.

4. For use by GNSSE equipped aircraft. GNSSE aircraft with selectable CDI must be set to 1 NM sensitivity. Aircraft without selectable CDI must use flight director.
 5. Refer to 10-4 Noise Abatement Procedures for additional requirements.

Apt Elev
569

TORONTO Departure
128.8 127.575

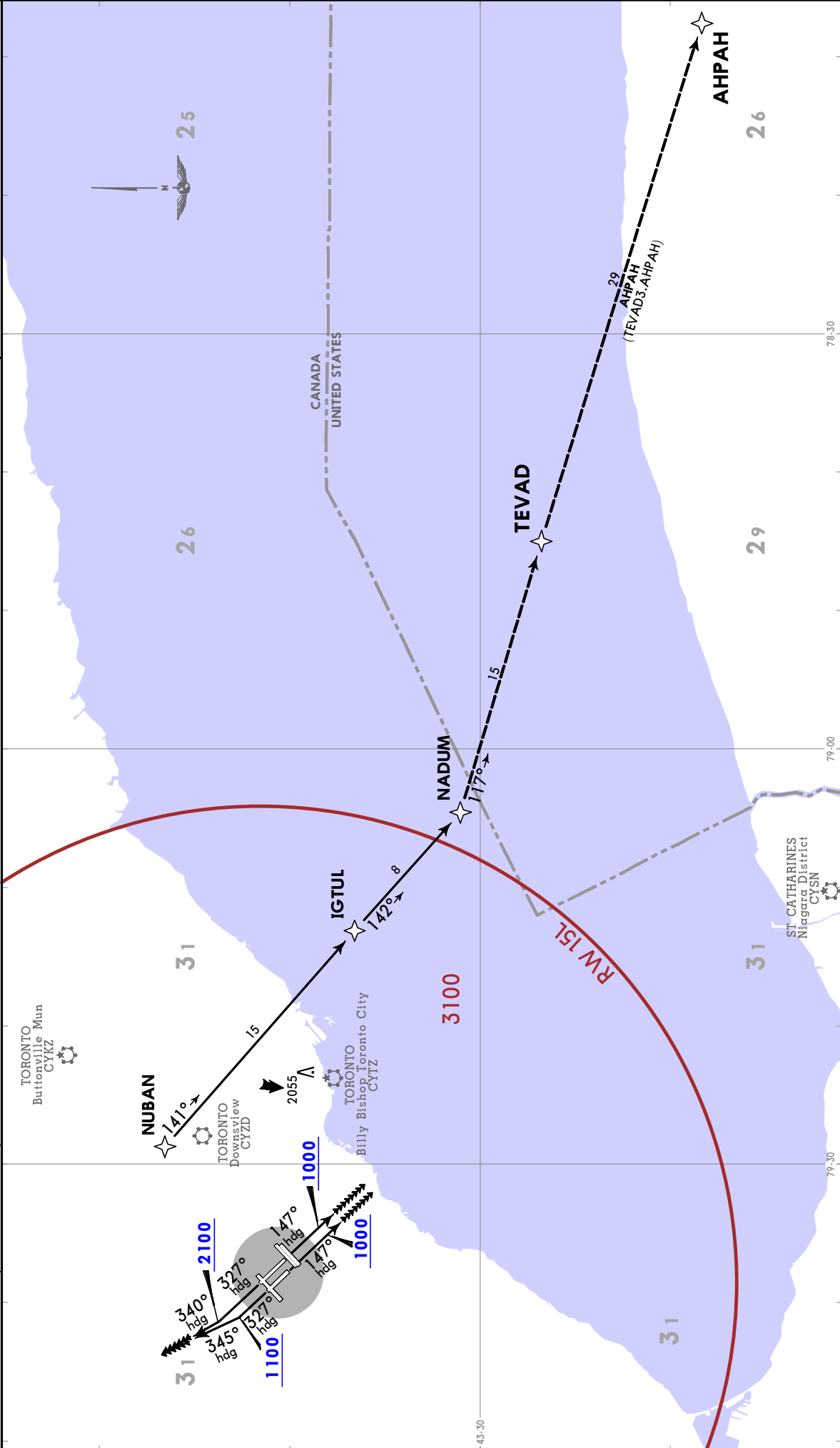

RWY	INITIAL CLIMB	ALTITUDE
15L/R	Unless otherwise assigned by ATC: Climb heading 147° to 1000. Continue climb heading 147° or as assigned. EXPECT RADAR vectors to NADUM (or as assigned), then proceed via depicted route.	Unless otherwise assigned by ATC: MAINTAIN 3000; Aircraft assigned a turn at takeoff; commence turn at 1100
33L	Unless otherwise assigned by ATC: Climb heading 327° to 1100. Climbing RIGHT turn heading 345° or as assigned. EXPECT RADAR vectors to NUBAN (or as assigned), then proceed via depicted route.	
33R	Unless otherwise assigned by ATC: Climb heading 327° to 2100. Climbing RIGHT turn heading 340° or as assigned. EXPECT RADAR vectors to NUBAN (or as assigned), then proceed via depicted route.	

On recognition of failure 20 minutes or less after take-off and in IFR weather conditions proceed as follows:
 1. Select transponder code 7600.
 2. Beyond 10 NM from CYZZ proceed directly on course.
 3. Do not climb above last assigned altitude for 5 minutes after recognition of failure.
 4. Climb to flight planned altitude.

This SID requires minimum climb gradients of:

Rwy	15L	15R	33L	33R
390 per NM	488	650	975	1300
1267	475	633	950	1267
1583	475	633	950	1267
1900	313	417	625	833
1250	313	417	625	833
300	75	100	150	200

CYYZ/YYZ
LESTER B PEARSON INTL

JEPPESEN
28 APR 23 **(10-3Q)**

TORONTO, ONT
SID

TORONTO Departure 128.8 127.575	Apt Elev 569	Trans alt: 18000 1. CAUTION: Rwy 05, 06L/R, 23, 24L/R departures: Simultaneous parallel departures in use. 2. Safe Altitude within 100 NM 4900. 3. Refer to 10-4 Noise Abatement Procedures for additional requirements.
--	------------------------	--

TORONTO 4 DEPARTURE (TRNTO4.) (VECTOR)

Day Procedure. For use between 0630-0000 local.

SPEED: MAX 250 KT BELOW 1000

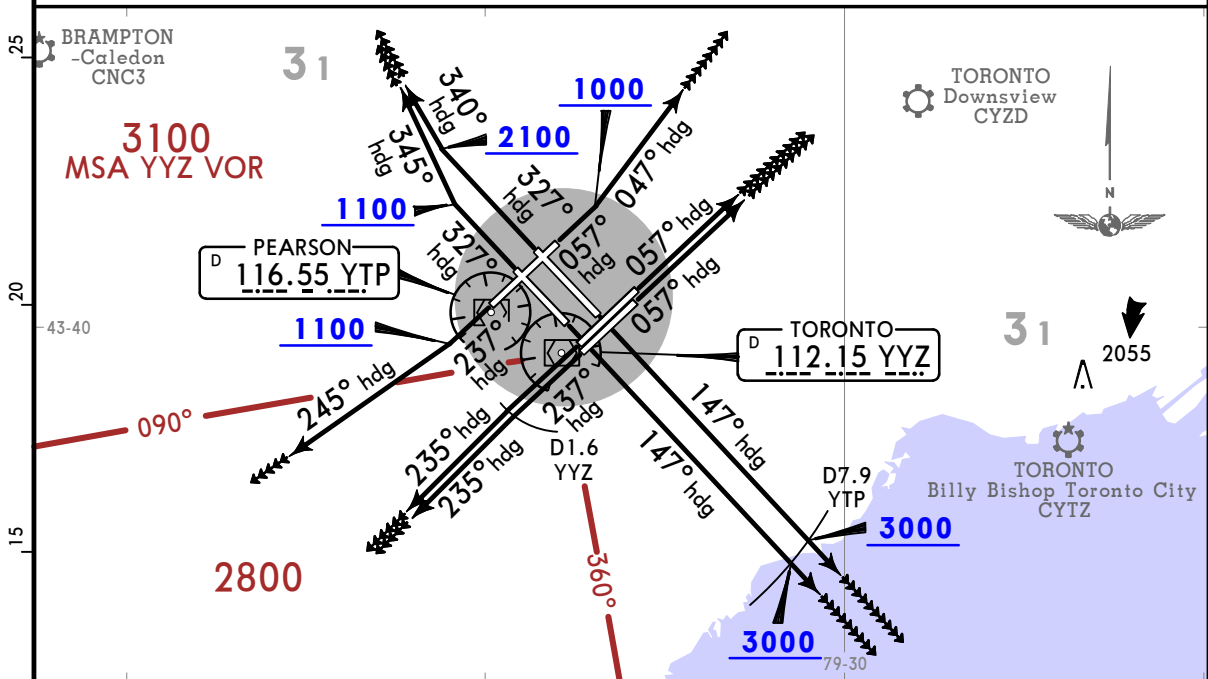

TURBOJET/FAN AIRCRAFT ONLY	
RWY	NOISE ABATEMENT DEPARTURE PROCEDURE
ALL RWYS	1 or 2

This SID requires minimum climb gradients of:

- Rwy 05: 360 per NM to 2700.
- Rwy 06L: 400 per NM to 2700.
- Rwy 06R: 390 per NM to 2700.
- Rwy 15L: 390 per NM to 3000.
- Rwy 15R: 380 per NM to 3000.
- Rwy 24L: 270 per NM to 1700.
- Rwy 24R: 260 per NM to 1700.
- Rwy 33L: 250 per NM to 900.

LOST COMMS ▼ LOST COMMS ▼ LOST COMMS ▼ LOST COMMS ▼
On recognition of a failure 20 minutes or less after take-off and in IFR weather conditions, proceed as follows:
1. Select transponder code 7600;
2. Beyond D10.0 YYZ proceed directly on course;
3. Do not climb above last assigned altitude for 5 minutes after recognition of failure, then;
4. Climb to flight plan altitude.
LOST COMMS ▲ LOST COMMS ▲ LOST COMMS ▲ LOST COMMS ▲ LOST

Gnd speed-KT	75	100	150	200	250	300
250 per NM	313	417	625	833	1042	1250
260 per NM	325	433	650	867	1083	1300
270 per NM	338	450	675	900	1125	1350
360 per NM	450	600	900	1200	1500	1800
380 per NM	475	633	950	1267	1583	1900
390 per NM	488	650	975	1300	1625	1950
400 per NM	500	667	1000	1333	1667	2000

① Unless otherwise assigned by ATC.

RWY	INITIAL CLIMB	ALTITUDE
05	Climb heading 057° to 1000. Climbing LEFT turn heading 047° or assigned heading for vectors to assigned route.	Jet aircraft MAINTAIN 5000. Non-jet aircraft MAINTAIN 3000. Aircraft assigned a turn at takeoff; commence turn at 1100
06L/R	Climb heading 057° or assigned heading for vectors to assigned route.	
15L/R	Climb heading 147° cross D7.9 YTP at or above 3000. MAINTAIN heading for vectors to assigned route.	
23	Climb heading 237° to 1100. Climbing RIGHT turn heading 245° or assigned heading for vectors to assigned route.	
24L/R	Climb heading 237°. At D1.6 YYZ, turn LEFT heading 235° or assigned heading for vectors to assigned route.	
33L	Climb heading 327° to 1100. Climbing RIGHT turn heading 345° or assigned heading for vectors to assigned route.	
33R	Climb heading 327° to 2100. Climbing RIGHT turn heading 340° or assigned heading for vectors to assigned route.	

TULEK 4 DEPARTURE (TULEK4.)
(RWYS 05, 06L/R, 23, 24L/R)

4. Non-Jet aircraft only.
 5. For use by GNSS equipped aircraft. GNSS aircraft with selectable CDI must be set to 1 NM sensitivity. Aircraft without selectable CDI must use flight director.
 6. Refer to 10-4 Noise Abatement Procedures for additional requirements.

Trans alt: 18000
 1. RADAR required.
 2. CAUTION: Rwys 05, 06L/R, 23, 24L/R departures: Simultaneous parallel departures in use.
 3. Safe Altitude within 100 NM 4900.

TORONTO Departure
128.8 127.575
 Apt Elev
569

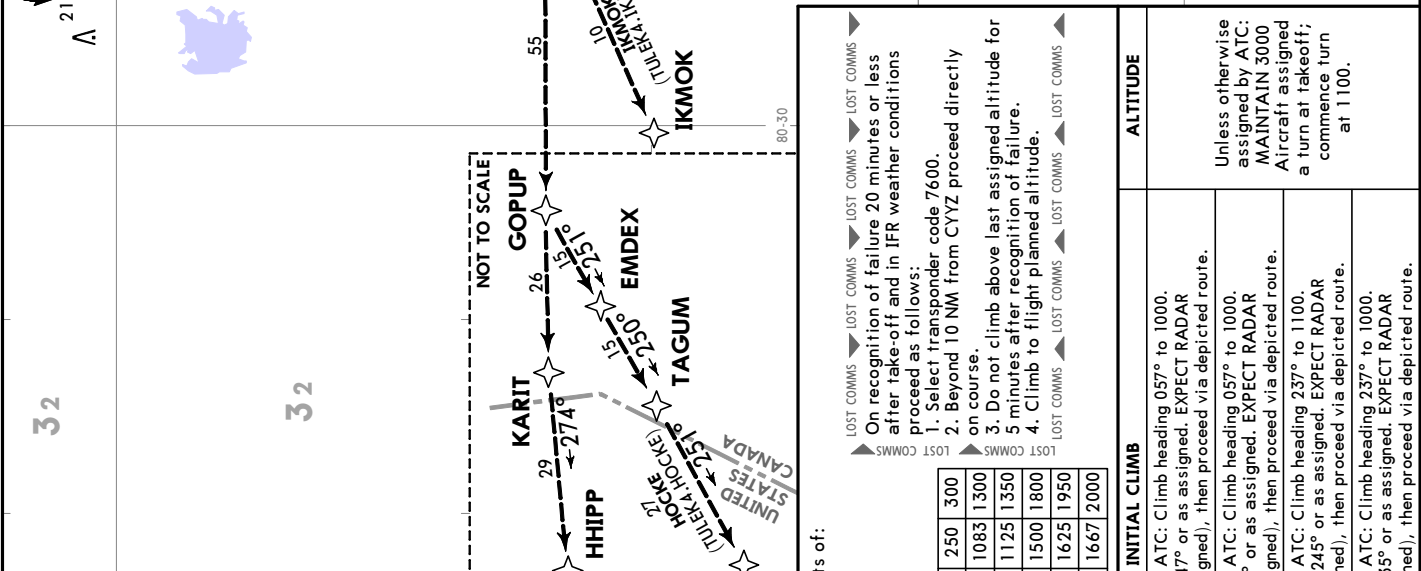
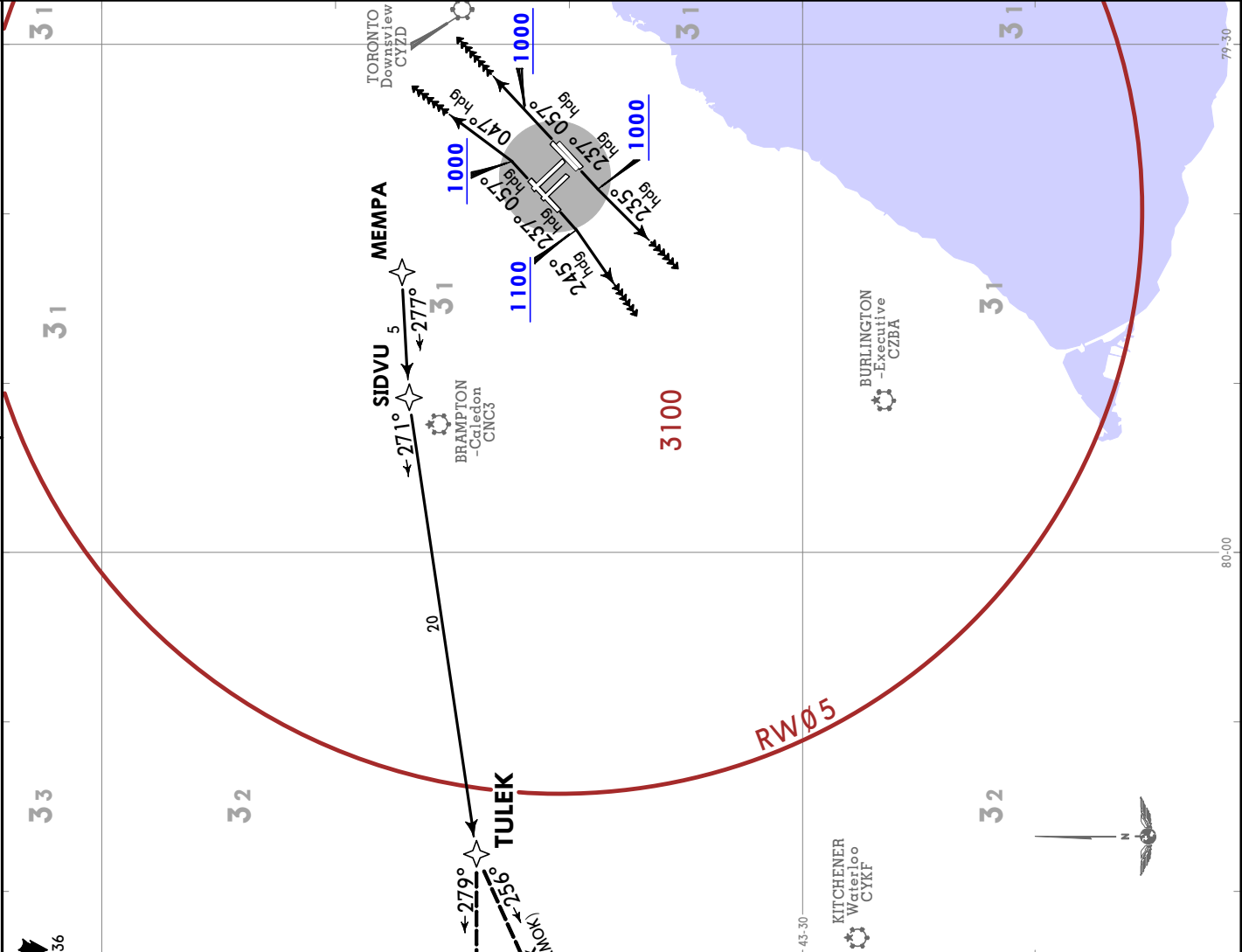

RWY	INITIAL CLIMB								ALTITUDE
	75	100	150	200	250	300	350	400	
05	325	433	650	867	1083	1300	1517	1733	Unless otherwise assigned by ATC: Climb heading 057° to 1000. Climbing LEFT turn heading 047° or as assigned. EXPECT RADAR vectors to MEMPA (or as assigned), then proceed via depicted route.
06L/R	338	450	675	900	1125	1350	1575	1800	Unless otherwise assigned by ATC: Climb heading 057° to 1000. Continue climb heading 057° or as assigned. EXPECT RADAR vectors to MEMPA (or as assigned), then proceed via depicted route.
23	450	600	900	1200	1500	1800	2100	2400	Unless otherwise assigned by ATC: Climb heading 237° to 1100. Climbing RIGHT turn heading 245° or as assigned. EXPECT RADAR vectors to TULEK (or as assigned), then proceed via depicted route.
24L/R	488	650	975	1300	1625	1950	2275	2600	Unless otherwise assigned by ATC: Climb heading 237° to 1000. Climbing LEFT turn heading 235° or as assigned. EXPECT RADAR vectors to TULEK (or as assigned), then proceed via depicted route.

Trans alt: 18000
 1. RADAR required.
 2. Safe Altitude within 100 NM 4900.
 3. Non-Jet aircraft only.
 4. For use by GNS equipped aircraft. GNS aircraft with selectable CDI must be set to 1 NM sensitivity. Aircraft without selectable CDI must use flight director.
 5. Refer to 10-4 Noise Abatement Procedures for additional requirements.

TORONTO Departure
 128.8
 127.575

Apt Elev
 569

TULEK 4 DEPARTURE (TULEK4.)
(RWYS 15L/R, 33L/R)

This SID requires minimum climb gradients of:

Rwy 15L: 390 per NM to 3000.	Rwy 15R: 380 per NM to 3000.	Rwy 33L: 250 per NM to 900.				
Gnd speed-KT	75	100	150	200	250	300
250 per NM	313	417	625	833	1042	1250
380 per NM	475	633	950	1267	1583	1900
390 per NM	488	650	975	1300	1625	1950

1. Select transponder code 7600.
 2. Beyond 10 NM from CYYZ proceed directly on course.
 3. Do not climb above last assigned altitude for 5 minutes after recognition of failure.
 4. Climb to flight planned altitude.

RWY	INITIAL CLIMB	ALTITUDE
15L/R	Unless otherwise assigned by ATC: Climb heading 147° to 1000. Continue climb heading 147° or as assigned. EXPECT RADAR vectors to IPSOT (or as assigned), then proceed via depicted route.	Unless otherwise assigned by ATC: MAINTAIN 3000 Aircraft assigned a turn at takeoff; commence turn at 1100.
33L	Unless otherwise assigned by ATC: Climb heading 327° to 1100. Climbing RIGHT turn heading 345° or as assigned. EXPECT RADAR vectors to TULEK (or as assigned), then proceed via depicted route.	
33R	Unless otherwise assigned by ATC: Climb heading 327° to 2100. Climb heading 340° or as assigned. EXPECT RADAR vectors to TULEK (or as assigned), then proceed via depicted route.	

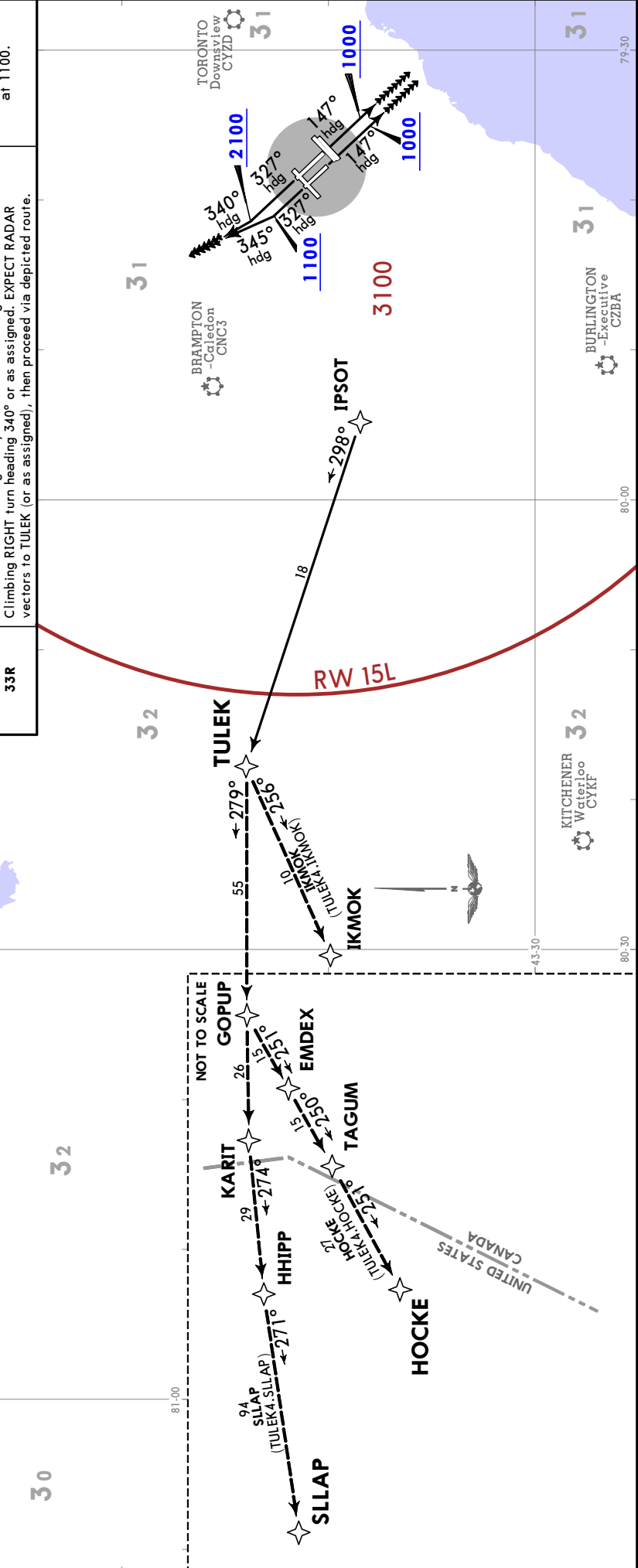

TORONTO Departure
128.8 127.575
Apt Elev 569

URSAL 4 DEPARTURE (URSAL4.)
(RWYS 05, 06L/R, 23, 24L/R)

Trans alt: 18000
1. RADAR required.
2. CAUTION: Rwys 05, 06L/R, 23, 24L/R departures: Simultaneous parallel departures in use.
3. Safe Altitude within 100 NM 4900.

4. Jet aircraft only.
5. For use by GNSS or D/D/I equipped aircraft. Aircraft with selectable CDI must be set to 1 NM sensitivity. Aircraft without selectable CDI must use flight director.
6. Refer to 10-4 Noise Abatement Procedures for additional requirements.

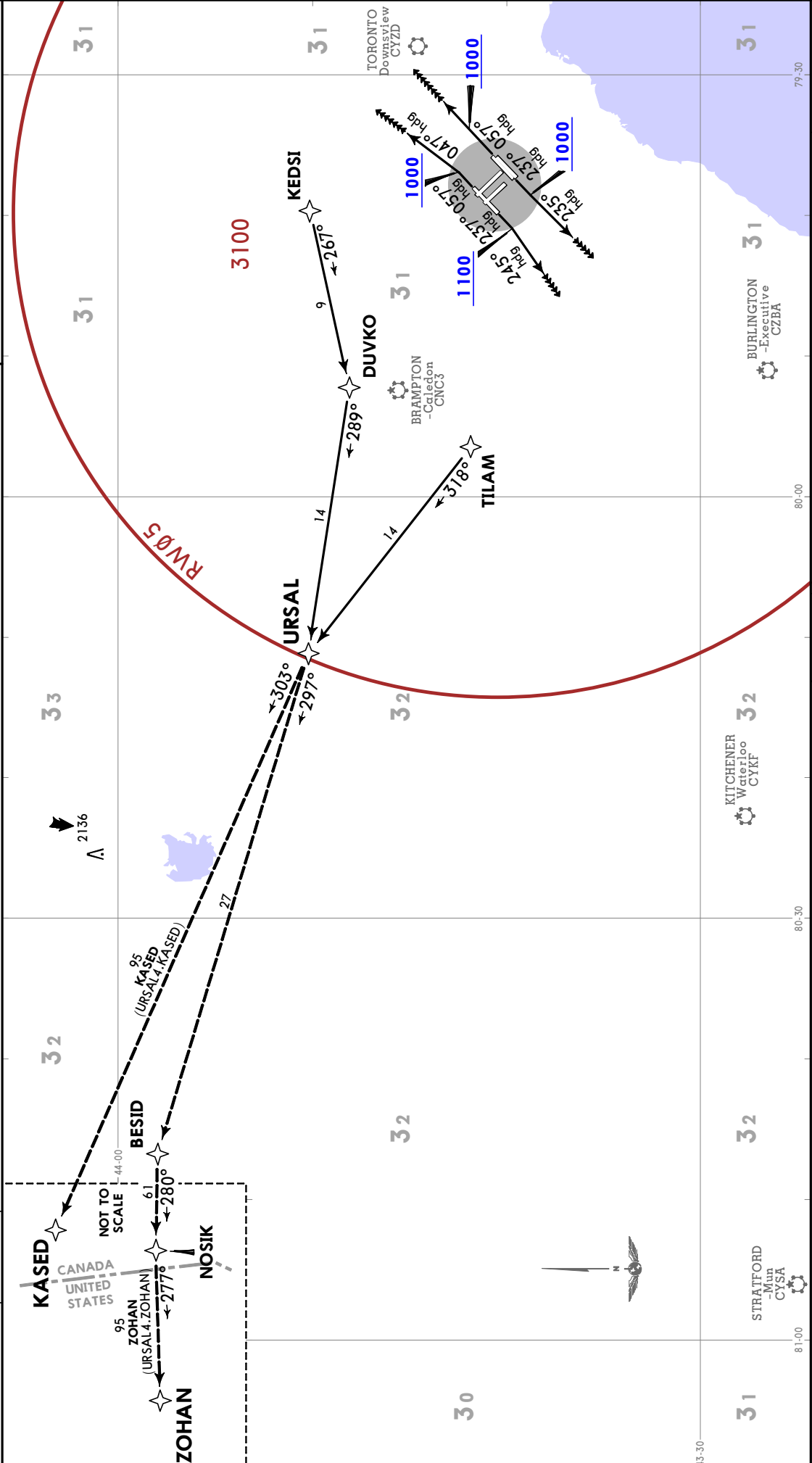

RWY	INITIAL CLIMB	ALTITUDE
05	Unless otherwise assigned by ATC: Climb heading 057° to 1000. Climbing LEFT turn heading 047° or as assigned. EXPECT RADAR vectors to KEDSI (or as assigned), then proceed via depicted route.	Unless otherwise assigned by ATC: MAINTAIN 5000
06L/R	Unless otherwise assigned by ATC: Climb heading 057° to 1000. Continue climb heading 057° or as assigned. EXPECT RADAR vectors to KEDSI (or as assigned), then proceed via depicted route.	
23	Unless otherwise assigned by ATC: Climb heading 237° to 1100. Climbing RIGHT turn heading 245° or as assigned. EXPECT RADAR vectors to TILAM (or as assigned), then proceed via depicted route.	
24L/R	Unless otherwise assigned by ATC: Climb heading 237° to 1000. Climbing LEFT turn heading 235° or as assigned. EXPECT RADAR vectors to TILAM (or as assigned), then proceed via depicted route.	

This SID requires minimum climb gradients of:

Rwy	05	06L/R	23	24L/R
Gnd speed-KT	75	100	150	200
260 per NM	325	433	650	867
270 per NM	338	450	675	900
360 per NM	450	600	900	1200
390 per NM	488	650	975	1300
400 per NM	500	667	1000	1333

LOST COMMS ▼ LOST COMMS ▼ LOST COMMS ▼ LOST COMMS ▼ LOST
 On recognition of failure 20 minutes or less after take-off and in IFR weather conditions proceed as follows:
 1. Select transmitter code 7600.
 2. Beyond 10 NM from CYYZ proceed directly on course.
 3. Do not climb above last assigned altitude for 5 minutes after recognition of failure.
 4. Climb to flight planned altitude.

LOST COMMS ▲ LOST COMMS ▲ LOST COMMS ▲ LOST COMMS ▲ LOST

JEPPESEN
 TORONTO, ONT
RNAV SID

CYYZ/YYZ
 LESTER B PEARSON INTL
 28 APR 23
 (10-3Q4)

Trans alt: 18000
 1. RADAR required.
 2. Safe Altitude within 100 NM 4900.
 3. Jet aircraft only.
 4. For use by GNS5 or D/D/I equipped aircraft. Aircraft with selectable CDI must be set to 1 NM sensitivity. Aircraft without selectable CDI must use flight director.
 5. Refer to 10-4 Noise Abatement Procedures for additional requirements.

TORONTO Departure
 128.8
 127.575

Apt Elev
 569

URSAL 4 DEPARTURE (URSAL4.)
(RWYS 15L/R, 33L/R)

This SID requires minimum climb gradients of:
 Rwy 15L: 390 per NM to 3000.
 Rwy 15R: 380 per NM to 3000.
 Rwy 33L: 250 per NM to 900.

Grnd speed-KT	75	100	150	200	250	300
250 per NM	313	417	625	833	1042	1250
380 per NM	475	633	950	1267	1583	1900
390 per NM	488	650	975	1300	1625	1950

On recognition of failure 20 minutes or less after take-off and in IFR weather conditions proceed as follows:
 1. Select transponder code 7600.
 2. Beyond 10 NM from CYYZ proceed directly on course.
 3. Do not climb above last assigned altitude for 5 minutes after recognition of failure.
 4. Climb to flight planned altitude.

RWY	INITIAL CLIMB	ALTITUDE
15L/R	Unless otherwise assigned by ATC: Climb heading 147° to 1000. Continue climb heading 147° or as assigned. EXPECT RADAR vectors to BOVAL (or as assigned), then proceed via depicted route.	
33L	Unless otherwise assigned by ATC: Climb heading 327° to 1100. Climbing RIGHT turn heading 345° or as assigned. EXPECT RADAR vectors to TETAD (or as assigned), then proceed via depicted route.	Unless otherwise assigned by ATC: MAINTAIN 5000
33R	Unless otherwise assigned by ATC: Climb heading 327° to 2100. Climbing RIGHT turn heading 340° or as assigned. EXPECT RADAR vectors to TETAD (or as assigned), then proceed via depicted route.	

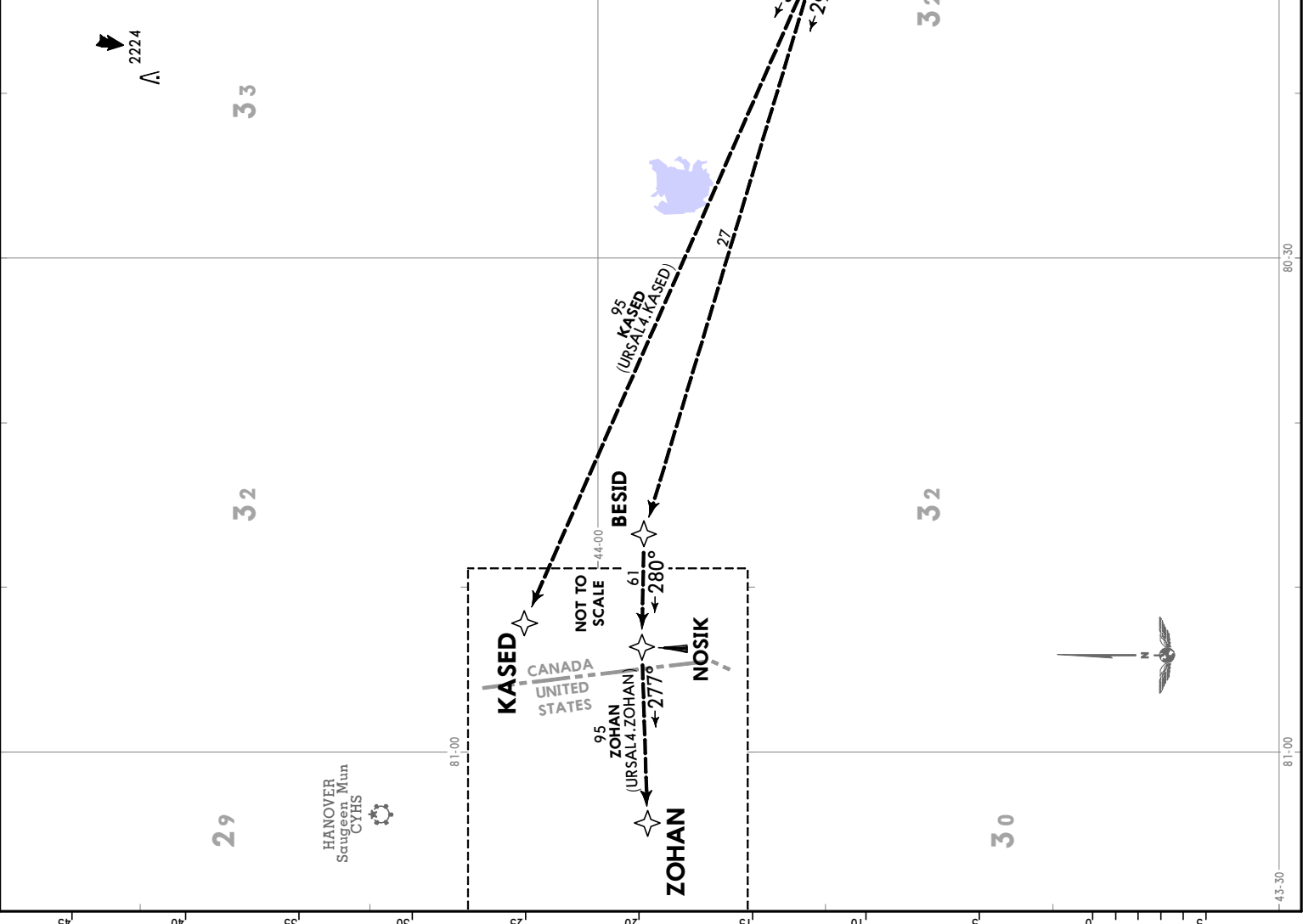

CYYZ/YYZ
LESTER B PEARSON INTL

JEPPESEN TORONTO, ONT
RNAV SID

28 APR 23 (10-3S)

VERDO 7 DEPARTURE (VERD07.)
(RWYS 05, 06L/R, 23, 24L/R)

4. Jet aircraft only.
5. For use by GNS or D/D/1 equipped aircraft. Aircraft with selectable CDI must be set to 1 NM sensitivity. Aircraft without selectable CDI must use flight director.
6. Refer to 10-4 Noise Abatement Procedures for additional requirements.

Trans alt: 18000
1. RADAR required.
2. CAUTION: Rwys 05, 06L/R, 23, 24L/R departures: Simultaneous parallel departures in use.
3. Safe Altitude within 100 NM 4900.

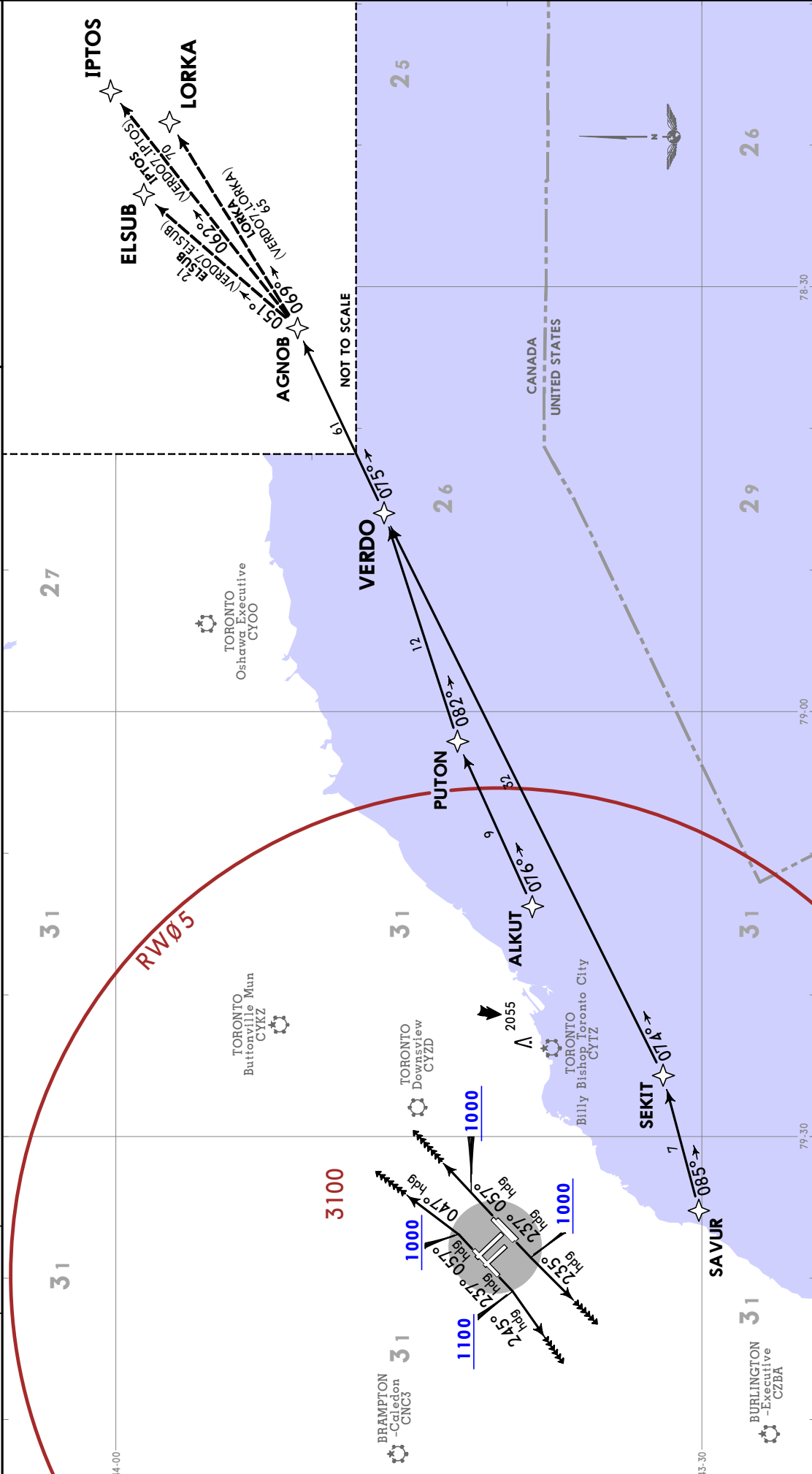

RWY	INITIAL CLIMB	ALTITUDE
05	Unless otherwise assigned by ATC: Climb heading 057° to 1000. Climbing LEFT turn heading 047° or as assigned. EXPECT RADAR vectors to ALKUT (or as assigned), then proceed via depicted route.	Unless otherwise assigned by ATC: MAINTAIN 5000
06L/R	Unless otherwise assigned by ATC: Climb heading 057° to 1000. Continue climb heading 057° or as assigned. EXPECT RADAR vectors to ALKUT (or as assigned), then proceed via depicted route.	
23	Unless otherwise assigned by ATC: Climb heading 237° to 1100. Climbing RIGHT turn heading 245° or as assigned. EXPECT RADAR vectors to SAVUR (or as assigned), then proceed via depicted route.	
24L/R	Unless otherwise assigned by ATC: Climb heading 237° to 1000. Climbing LEFT turn heading 235° or as assigned. EXPECT RADAR vectors to SAVUR (or as assigned), then proceed via depicted route.	

This SID requires minimum climb gradients of:

Gnd speed-KT	75	100	150	200	250	300
Rwy 05: 360 per NM to 2700.	325	433	650	867	1083	1300
Rwy 06L: 400 per NM to 2700.	338	450	675	900	1125	1350
Rwy 06R: 390 per NM to 2700.	450	600	900	1200	1500	1800
Rwy 24L: 270 per NM to 1700.	488	650	975	1300	1625	1950
Rwy 24R: 260 per NM to 1700.	500	667	1000	1333	1667	2000

LOST COMMS ▼ LOST COMMS ▼ LOST COMMS ▼ LOST
On recognition of failure 20 minutes or less after take-off and in IFR weather conditions proceed as follows:
1. Select transponder code 7600.
2. Beyond 10 NM from CYYZ proceed directly on course.
3. Do not climb above last assigned altitude for 5 minutes after recognition of failure.
4. Climb to flight planned altitude.
LOST COMMS ▲ LOST COMMS ▲ LOST COMMS ▲ LOST

JEPPESEN
28 APR 23 (10-3T)
TORONTO, ONT
RNAV SID

CYYZ/YYZ
LESTER B PEARSON INTL

4. For use by GNSS or D/D/I equipped aircraft. Aircraft with selectable CDI must be set to 1 NM sensitivity. Aircraft without selectable CDI must use flight director.
5. Refer to 10-4 Noise Abatement Procedures for additional requirements.

Trans alt: 18000
1. RADAR required.
2. Safe Altitude within 100 NM 4900.
3. Jet aircraft only.

Apt Elev
569

TORONTO Departure
128.8 127.575

VERDO 7 DEPARTURE (VERD07.)
(RWYS 15L/R, 33L/R)

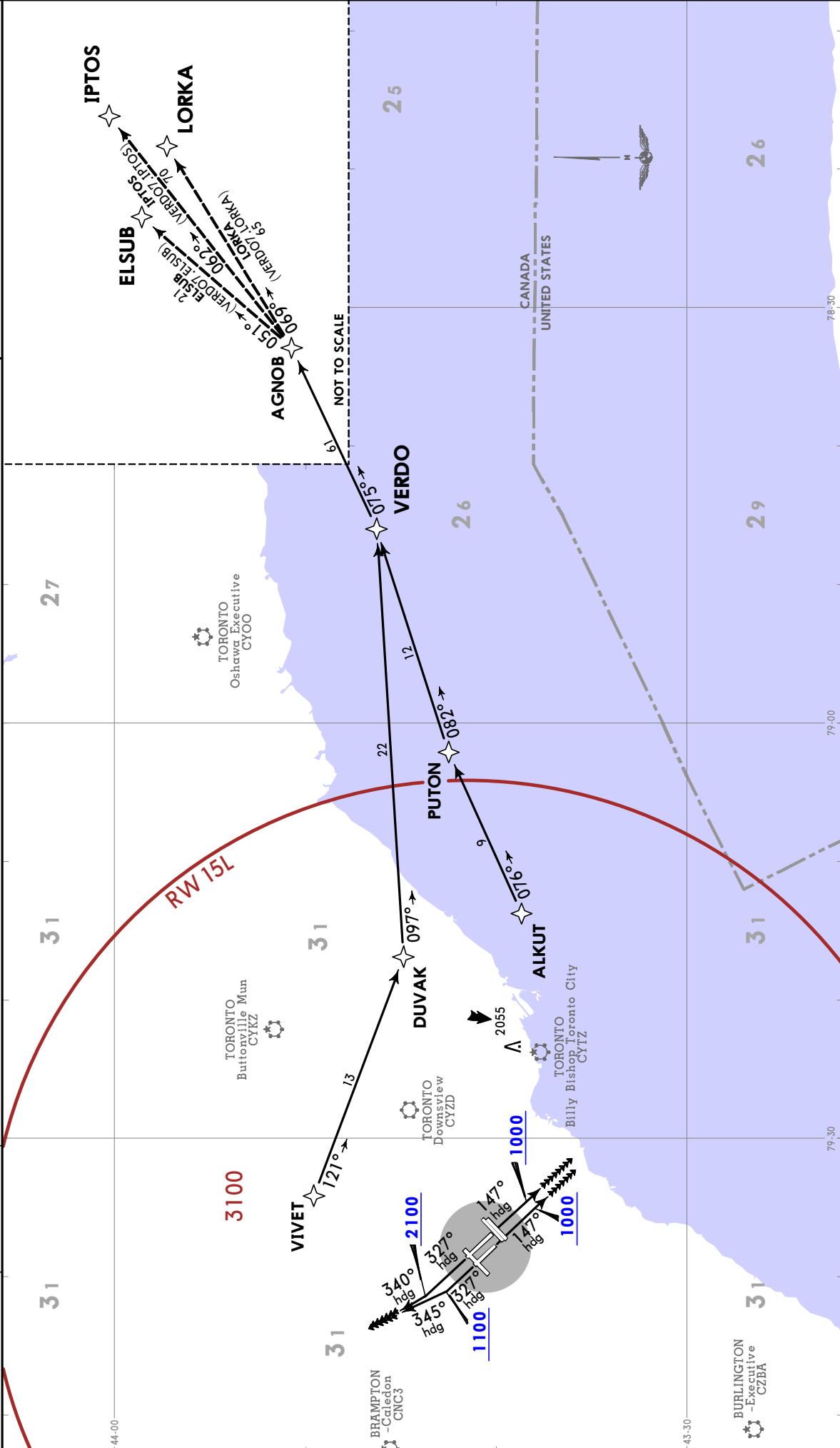

RWY	INITIAL CLIMB	ALTITUDE
15L/R	Unless otherwise assigned by ATC: Climb heading 147° to 1000. Continue climb heading 147° or as assigned. EXPECT RADAR vectors to ALKUT (or as assigned), then proceed via depicted route.	Unless otherwise assigned by ATC: MAINTAIN 5000
33L	Unless otherwise assigned by ATC: Climb heading 327° to 1100. Climbing RIGHT turn heading 345° or as assigned. EXPECT RADAR vectors to VIVET (or as assigned), then proceed via depicted route.	Unless otherwise assigned by ATC: MAINTAIN 5000
33R	Unless otherwise assigned by ATC: Climb heading 327° to 2100. Climbing RIGHT turn heading 340° or as assigned. EXPECT RADAR vectors to VIVET (or as assigned), then proceed via depicted route.	Unless otherwise assigned by ATC: MAINTAIN 5000

This SID requires minimum climb gradients of:

Rwy	15L	15R	33L	33R
390 per NM	488	650	975	1300
1583 1900	475	633	950	1267
1042 1250	313	417	625	833
300	75	100	150	200

NOISE ABATEMENT PROCEDURES

DAYLIGHT : LT plus 4 HOURS= UTC(Z)
STANDARD : LT plus 5 HOURS= UTC(Z)

GENERAL

Noise Operating Restrictions and Noise Abatement Procedures apply, at Toronto/Lester B. Pearson Intl Airport, to all IFR and VFR Aircraft, unless otherwise specified.

NOISE OPERATING RESTRICTIONS

A. Restrictions:

1. Arrivals and departures of all aircraft are restricted as per the table below:

AIRCRAFT	RESTRICTED HOURS - LOCAL TIME
Noise Certification or Type	Arrivals & Departures
All Non-noise Certificated Jet Aircraft	2000 - 0800
All ICAO Annex 16, Vol 1 Chapter 2 & equivalent Aircraft	0000 - 0700
All ICAO Annex 16, Vol 1 Chapter 3 & equivalent Aircraft (subject to paragraph 4 or 5)	0030 - 0630
All other Aircraft (subject to paragraph 4 or 5)	0030 - 0630

2. Non-noise certificated jet powered aircraft are prohibited from departing on runways 05, 06L, 06R, 15L, 15R and 33L.
3. Between 0000 and 0630 local time, departures are prohibited on runways 05, 06L, 06R, 15L and 15R and arrivals are prohibited on runways 24R, 24L, 23, 33R, 33L and 15R unless assigned by ATC.
4. All aircraft operating on a scheduled and repetitive basis are required to obtain an extension or an exemption to operate during the restricted hours. Submit requests for operating extensions on the day of operation to the Greater Toronto Airports Authority with justification at 416-776-3480, or 1-800-267-SLOT (7568), (Fax 416-776-5552). For advance exemption requests or information, make submission in writing to the

Manager
 Slots Coordination
 Greater Toronto Airports Authority
 Toronto Pearson International Airport
 P.O. Box 6031 Toronto AMF, Ontario
 L5P 1B2
 (Fax 416-776-3483)

5. **ALL OTHER OPERATORS ARE REQUIRED TO OBTAIN PERMISSION TO OPERATE DURING THE RESTRICTED HOURS** by contacting the Greater Toronto Airports Authority on the day of operation at 416-776-3480 or 1-800-267-SLOT (7568), (Fax 416-776-5552).

NOISE ABATEMENT PROCEDURES

B. Preferential runway assignment (0000 - 0629 local time).

Consistent with operational safety (i.e., wind, weather, runway conditions, approach aid availability etc.), ATC will assign runways in the following order of priority.

AMENDED PREFERENTIAL RUNWAY SYSTEM			
PREFERENCE	ARRIVALS	DEPARTURES	NOTES
1	05 (06L/R)	33R (33L)	Use as a Pair
2	15L (15R)	23 (24L/R)	Use as a Pair

Note: Runways in brackets are available when the corresponding preferential runway is not available.

PROVISION FOR WEATHER AND INFRASTRUCTURE AVAILABILITY			
OPTION	ARRIVALS	DEPARTURES	NOTES
Northerly	33R (33L)	33R (33L)	Single Runway Operation
Southerly	15L (15R)	15L (15R)	Single Runway Operation
Westerly	23 (24R/L)	23 (24R/L)	Single Runway Operation
Easterly	05 (06L/R)	05 (06L/R)	Single Runway Operation

Note: NAV CANADA may use any of these runways, as required, when the first and second preference pairs are unavailable or not an appropriate choice.

Operators shall comply with the amended nighttime preferential runway system, which is in effect every day from 00:00 to 06:29 local time. Approval during this time is required for any requests for non-preferential runway departures, arrivals, or both. These requests are to be directed to GTAA Airport Duty Manager (416-776-3030).

C. Engine Run-ups

Between 0000 - 0700 local time, maintenance run-ups are prohibited unless authorized by the Greater Toronto Airports Authority (416-776-3056).

D. Training Flights

Training flights are not permitted in the Toronto Control Zone from 0000 - 0700 local time. For other times, prior permission is required from National Traffic Management Unit (FLOW CTL) 800-268-4831 or 905-676-3528.

NOISE ABATEMENT PROCEDURES (GENERAL)

A. Reverse Thrust

Consistent with safe operating procedures, plan landing using idle reverse thrust.

CYYZ/YYZ

28 APR 23

10-4B

TORONTO, ONT
LESTER B PEARSON INTL

NOISE ABATEMENT PROCEDURES

B. 0700 - 2300 local time

Except in emergencies, Noise Abatement Procedures as outlined in 1. and 2. below apply to all turbo-jet and turbo-fan powered aircraft.

1. Departure Procedure:

- (a) NADP 1 or 2 is required for all runways. See Jeppesen Canada ATC para 7.6. or Canada Rules and Procedures Noise Abatement, if held.
- (b) SID routing shall be followed to 3600' AMSL. For Rwys 33L and 33R, no unauthorized turns until abeam YYZ R-343/4.0 DME.

NOTE: SID cancellation does not terminate Noise Abatement Procedure.

- (c) Early Turn-Rwys 05, 06L, 06R, 23, 24L 24R, departures: Applies only to the following jet aircraft types - CRJ1, CRJ2, E135, E145, E45X, J328, CL60, C750, GLEX, GLF4, and GLF5. Commence turn assigned at take-off at 1100' AMSL.

2. Arrival Procedures:

Consistent with safety, crews shall minimize approach noise. For all approaches including visual approaches:

- (a) Maintain 3000' AMSL or above until intercepting extended runway centerline, and;
- (b) Intercept extended runway centerline at or outside Final Approach Fix, then;
- (c) Remain on or above glide slope or assumed 3.0° glide slope.

C. 2301 - 0659 local time**1. Procedures:**

Departure Procedures 1. (b) above, and Arrival Procedures 2. above apply to all aircraft. Departure Procedure 1. (a) above applies to Turbo-jet and Turbo-fan powered aircraft only.

CYYZ/YYZ

JEPPesen

TORONTO, ONT

28 APR 23 (10-8)

LESTER B PEARSON INTL

**TORONTO/LESTER B. PEARSON INTERNATIONAL AIRPORT, ON (CYYZ)
CONSTRUCTION ACTIVITIES SPRING/SUMMER 2023 (SUP 16/23)**

Introduction

The scope and potential impacts from **mid-April to mid-October 2023** construction projects at Toronto/Lester B. Pearson International Airport are outlined herein.

Since all activities are subject to operational requirements and construction schedules, actual dates and times of construction activities will be promulgated through briefing documents and NOTAM.

CYYZ Runway and Taxiway Area identification diagram

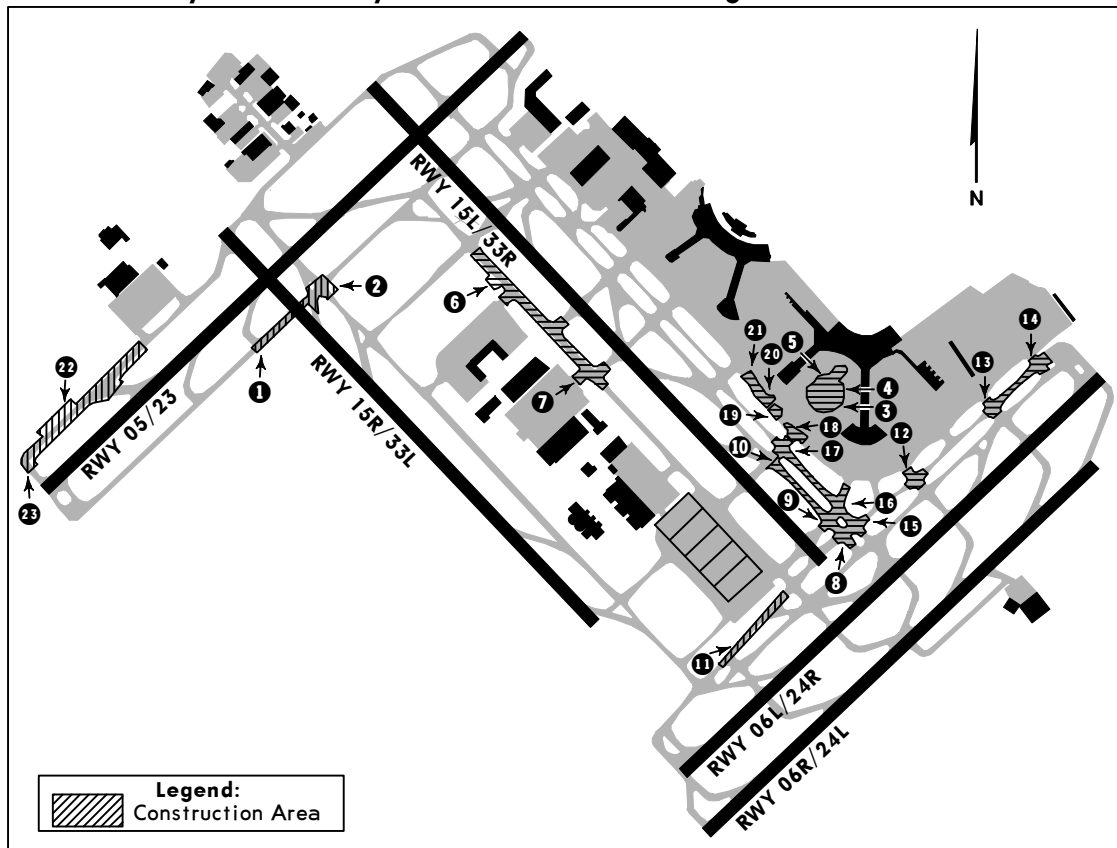

- 1 Construction Activity Taxiway H
- 2 Construction Activity Taxiway H and Taxiway F
- 3 Rehabilitation Activity Old T1 Footprint - Phase 1
- 4 Rehabilitation Activity Old T1 Footprint - Phases 1 and 1A Combined
- 5 Rehabilitation Activity Old T1 Footprint - Phase 2
- 6 Construction Activity Taxiway E - Phase 1 and 1A
- 7 Construction Activity Taxiway E - Phase 2 and 2A
- 8 Construction Activity Taxiway B - Phase 1 and 1A
- 9 Construction Activity Taxiway B - Phase 2 and 2A
- 10 Construction Activity Taxiway B - Phase 3
- 11 Construction Activity Taxiway D - Phase 1
- 12 Construction Activity Taxiway D and Taxiway DQ
- 13 Construction Activity Taxiway D and Taxiway DT
- 14 Construction Activity Taxiway D and Taxiway DV
- 15 Construction Activity Taxiway A - Phase 1 and 1A
- 16 Construction Activity Taxiway A - Phase 2 and 2A
- 17 Construction Activity Taxiway A - Phase 3 and 3A
- 18 Construction Activity T1 Apron - Phase 1
- 19 Construction Activity T1 Apron - Phase 2
- 20 Construction Activity T1 Apron - Phase 3
- 21 Construction Activity T1 Apron - Phase 4
- 22 Construction Activity Taxiway JC
- 23 Construction Activity Taxiway J

CYYZ/YYZ

JEPPesen

TORONTO, ONT

28 APR 23 (10-8A)

LESTER B PEARSON INTL

**TORONTO/LESTER B. PEARSON INTERNATIONAL AIRPORT, ON (CYYZ)
CONSTRUCTION ACTIVITIES SPRING/SUMMER 2023 (CONTD 1) (SUP 16/23)**

Area 1 - Construction Activity Taxiway H

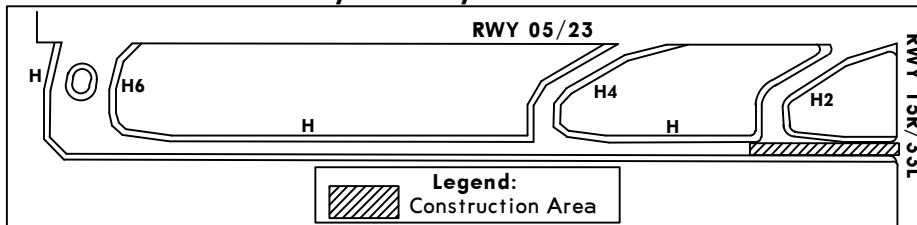

Dates: Mid-September 2023

Scope: Taxiway surface and base rehabilitation

Impacts:

- Runway 15R/33L **closed**
- Taxiway H **closed** between Runway 05 and Runway 15R
- Taxiway H2 **closed**
- Taxiway H4 **restricted** to Code C aircraft
- Taxiway H6 **restricted** to Code C aircraft
- Taxiway H between Taxiway H4 and Runway 05 **restricted** to Code C aircraft

Area 2 - Construction Activity Taxiway H and Taxiway F

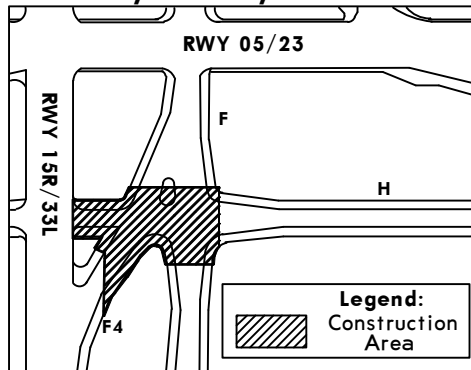

Dates: Early September 2023 to late September 2023

Scope: Taxiway surface and base rehabilitation

Impacts:

- Runway 15R/33L **closed**, available as a taxiway
- Taxiway F **closed** between Taxiway F2 and Runway 05/23
- Taxiway H **closed** between Runway 15R/33L and Taxiway G
- Taxiway F4 **closed**

Area 3 - Rehabilitation Activity Old T1 Footprint - Phase 1

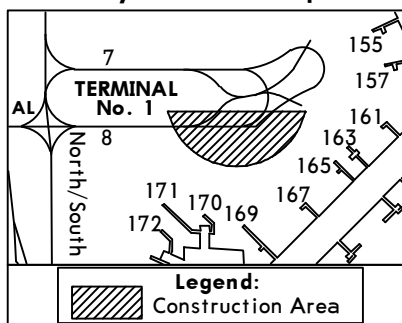

Dates: Late April 2023 to early May 2023

Scope: Apron concrete surface rehabilitation

Impacts:

- Taxilane 8 **closed** east of Startbox 8B
- Stands 170, 169, 167, 165, 163, and 161A **closed**
- Green centerline lighting **unavailable** on Taxilanes 7 and 8

**TORONTO/LESTER B. PEARSON INTERNATIONAL AIRPORT, ON (CYYZ)
CONSTRUCTION ACTIVITIES SPRING/SUMMER 2023 (CONTD 2) (SUP 16/23)**

Area 4 - Rehabilitation Activity Old T1 Footprint - Phases 1 and 1A Combined

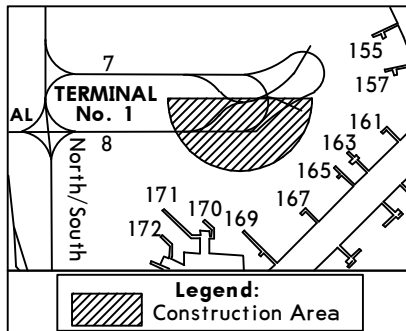

Dates: Late April 2023 to early May 2023

Scope: Apron concrete surface rehabilitation

Impacts:

- Taxiway 8 **closed** east of Startbox 8B
- Taxiway 7 **restricted** to Code C aircraft and smaller east of Stand 145
- Stands 170, 169, 167, 165, 163, and 157 **closed**
- Green centerline lighting **unavailable** on Taxiways 7 and 8

Area 5 - Rehabilitation Activity Old T1 Footprint - Phase 2

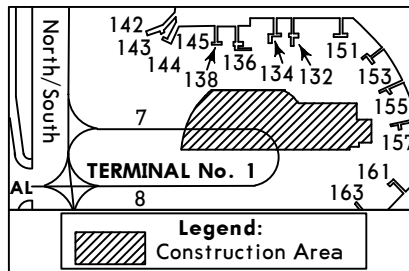

Dates: Early May 2023 to mid May 2023

Scope: Apron surface and base rehabilitation

Impacts:

- Taxiway 7 **closed** east of Startbox 7B
- Stands 145, 138, 136, 134, 132, 151, 153, 155, 157, 161A, and 163 **closed**
- Green centerline lighting unavailable on Taxiways 7 and 8

Area 6 - Construction Activity Taxiway E - Phase 1 and 1A

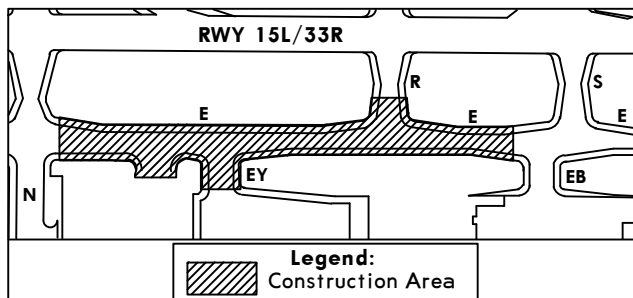

Dates: Mid May 2023 to Late May 2023

Scope: Taxiway surface rehabilitation

Impacts:

- Runway 15L/33R certification changed to **non-instrument**
- Taxiway E **closed** between Taxiway N and Taxiway EB
- Taxiway R **closed** between Taxiway E and Runway 15L/33R
- Taxiway EY **closed**
- Phase 1A Runway 15L/33R **closed** nightly

CYYZ/YYZ

JEPPesen

TORONTO, ONT

28 APR 23 (10-8C)

LESTER B PEARSON INTL

**TORONTO/LESTER B. PEARSON INTERNATIONAL AIRPORT, ON (CYYZ)
CONSTRUCTION ACTIVITIES SPRING/SUMMER 2023 (CONTD 3) (SUP 16/23)**

Area 7 - Construction Activity Taxiway E - Phase 2 and 2A

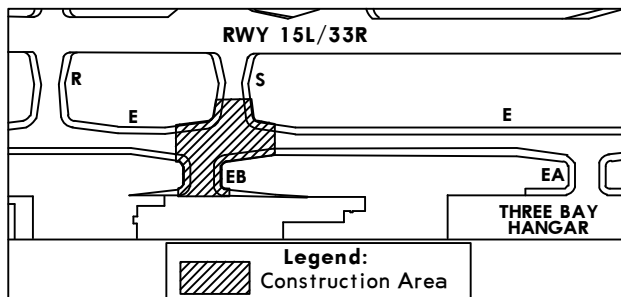

Dates: Late May 2023

Scope: Taxiway surface rehabilitation

Impacts:

- Runway 15L/33R certification changed to **non-instrument**
- Taxiway E **closed** between Taxiway R and Taxiway EA
- Taxiway S **closed** between Taxiway E and Runway 15L/33R
- Taxiway EB **closed**
- Phase 2A Runway 15L/33R **closed** nightly

Area 8 - Construction Activity Taxiway B - Phase 1 and 1A

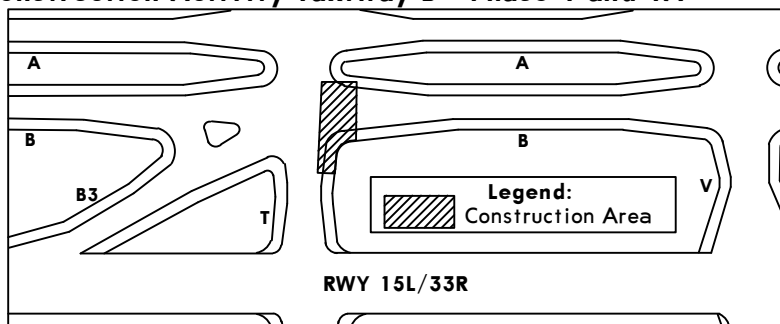

Dates: Late June 2023

Scope: Taxiway surface rehabilitation

Impacts:

- Runway 15L/33R certification changed to **non-instrument**
- Taxiway B **closed** between Taxiway B3 and Taxiway V
- Taxiway T **closed** between Taxiway A and Runway 15L/33R
- Taxiway B3 **restricted** to northbound turns onto Taxiway B only
- Phase 1A Runway 15L/33R **closed** nightly

Area 9 - Construction Activity Taxiway B - Phase 2 and 2A

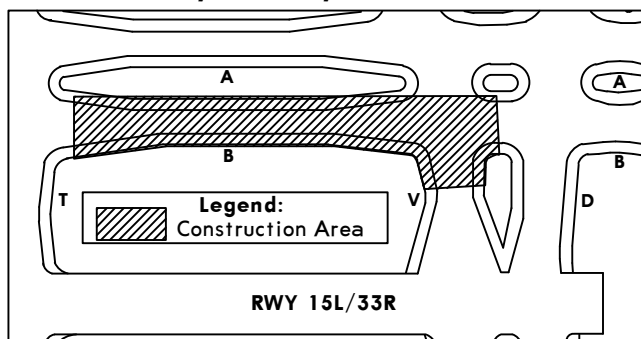

Dates: Late June 2023 to mid-July 2023

Scope: Taxiway surface rehabilitation

Impacts:

- Runway 15L/33R certification changed to **non-instrument**
- Taxiway B **closed** between Taxiway T and Taxiway D
- Taxiway V **closed** between Taxiway A and Runway 15L/33R
- Taxiway D between Taxiway A and Runway 15L/33R **restricted** to Code E aircraft
- Phase 2A Runway 15L/33R **closed** nightly

CYYZ/YYZ

JEPPesen
28 APR 23 (10-8D)

TORONTO, ONT
LESTER B PEARSON INTL

**TORONTO/LESTER B. PEARSON INTERNATIONAL AIRPORT, ON (CYYZ)
CONSTRUCTION ACTIVITIES SPRING/SUMMER 2023 (CONTD 4) (SUP 16/23)**

Area 10 - Construction Activity Taxiway B - Phase 3

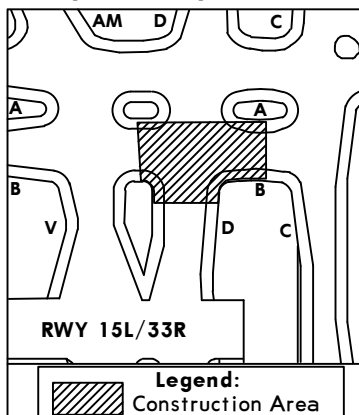

Dates: Mid July 2023 to late July 2023

Scope: Taxiway surface rehabilitation

Impacts:

- Runway 15L/33R certification changed to **non-instrument**
- Taxiway B **closed** between Taxiway V and Taxiway C
- Taxiway D **closed** between Taxiway A and Runway 15L/33R
- Taxiway C between Taxiway A and Runway 15L/33R **restricted** to Code E aircraft

Area 11 - Construction Activity Taxiway D - Phase 1

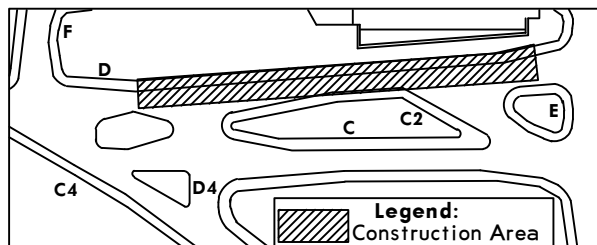

Dates: Mid-July 2023 to Late August 2023

Scope: Taxiway surface and base rehabilitation

Impacts:

- Taxiway D **closed** between Taxiway C4 and Taxiway E
- Taxiway D4 **closed** between Taxiway C and Taxiway D
- Taxiway C2 **closed** between Taxiway C and Taxiway D

Area 12 - Construction Activity Taxiway D and Taxiway DQ

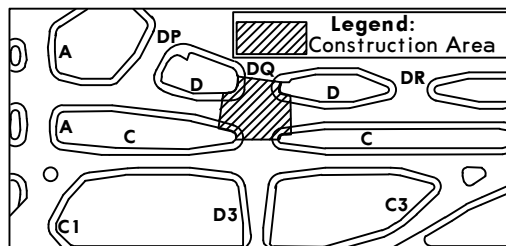

Dates: Early June 2023 to mid-June 2023

Scope: Taxiway surface rehabilitation

Impacts:

- Taxiway DQ **closed**
- Taxiway D **closed** between Taxiway DP and Taxiway DR
- Taxiway D3 North of Taxiway C **closed**
- Taxiway C between Taxiway C1 and Taxiway C3 **restricted** to Code C aircraft nightly

CYYZ/YYZ

JEPPESEN

TORONTO, ONT

28 APR 23 (10-8E)

LESTER B PEARSON INTL

**TORONTO/LESTER B. PEARSON INTERNATIONAL AIRPORT, ON (CYYZ)
CONSTRUCTION ACTIVITIES SPRING/SUMMER 2023 (CONTD 5) (SUP 16/23)**

Area 13 - Construction Activity Taxiway D and Taxiway DT

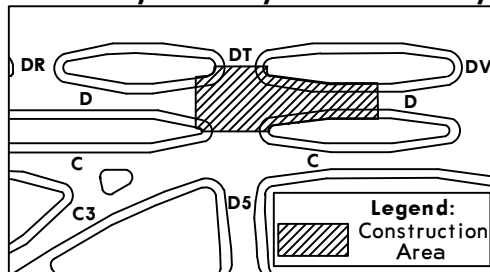

Dates: Early August 2023

Scope: Taxiway surface rehabilitation

Impacts:

- Taxiway DT **closed**
- Taxiway D **closed** between Taxiway DR and Taxiway DV
- Taxiway D5 north of Taxiway C **closed**
- Taxiway C between Taxiway DV and Taxiway C3 **restricted** to Code C aircraft nightly

Area 14 - Construction Activity Taxiway D and Taxiway DV

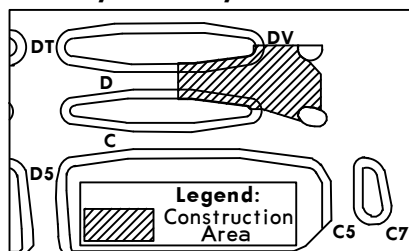

Dates: Mid-August 2023

Scope: Taxiway surface rehabilitation

Impacts:

- Taxiway DV **closed**
- Taxiway D **closed** between Taxiway DT and Taxiway C7
- Taxiway C5 **closed** between Taxiway D and Taxiway C
- Taxiway C7 **closed** between Taxiway D and Taxiway C
- Taxiway C between Taxiway D5 and Taxiway C7 **restricted** to Code C aircraft nightly

Area 15 - Construction Activity Taxiway A - Phase 1 and 1A

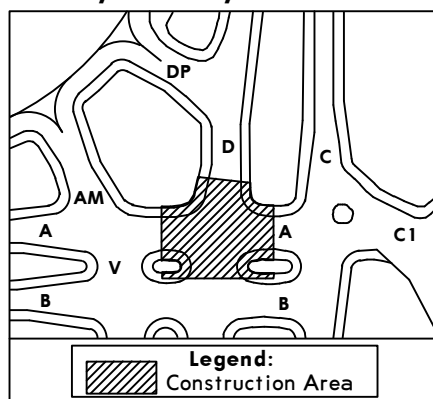

Dates: Late August 2023

Scope: Taxiway surface rehabilitation

Impacts:

- Taxiway D **closed** between Taxiway DP and Taxiway B
- Taxiway A **closed** between Taxiway V and Taxiway C
- Taxiway AM **restricted** to Code E aircraft
- Phase 1A Taxiway B between Taxiway D and Taxiway V **restricted** to Code C aircraft nightly

CYYZ/YYZ

JEPPesen

TORONTO, ONT

28 APR 23 (10-8F)

LESTER B PEARSON INTL

**TORONTO/LESTER B. PEARSON INTERNATIONAL AIRPORT, ON (CYYZ)
CONSTRUCTION ACTIVITIES SPRING/SUMMER 2023 (CONTD 6) (SUP 16/23)**

Area 16 - Construction Activity Taxiway A - Phase 2 and 2A

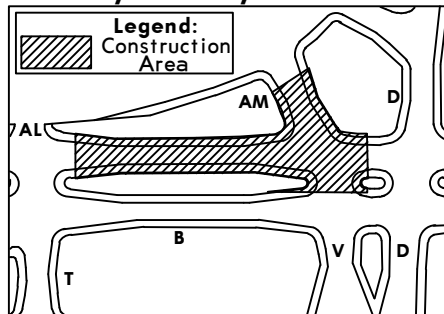

Dates: Late August 2023 to mid-September 2023

Scope: Taxiway surface rehabilitation

Impacts:

- Taxiway A **closed** between Taxiway D and Taxiway T
- Taxiway AM **closed**
- Phase 2A Taxiway B between Taxiway D and Taxiway T **restricted** to Code C aircraft nightly

Area 17 - Construction Activity Taxiway A - Phase 3 and 3A

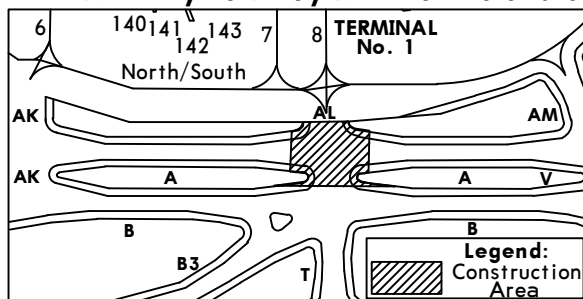

Dates: Mid-September 2023

Scope: Taxiway surface rehabilitation

Impacts:

- Taxiway A **closed** between Taxiway AK and Taxiway V
- Taxiway AL **closed**
- Taxiway T **closed** between Taxiway B and Taxiway AL
- Phase 3A Taxiway B between Taxiway B3 and Taxiway V **restricted** to Code C aircraft nightly

Area 18 - Construction Activity T1 Apron - Phase 1

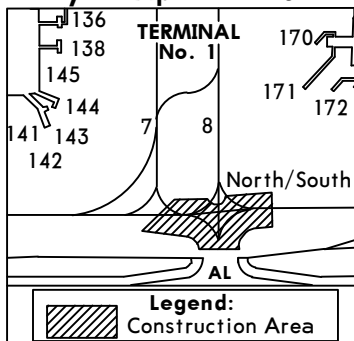

Dates: Mid-May 2023 to mid-June 2023

Scope: Apron Concrete Surface Rehabilitation

Impacts:

- Taxiway AL **closed**
- Taxilane 7 between Startbox 7B and the North/South Taxilane **relocated**
- Taxilane 8 between the North/South Taxilane and Stand 171 **closed**
- North/South Taxilane between Taxilane 7 and Stand 172 **closed**
- Green centerline lighting **unavailable** on Terminal Perimeter Taxilane
- Green centerline lighting **unavailable** on Taxilanes 7 and 8

CYYZ/YYZ

JEPPesen

28 APR 23 (10-8G)

TORONTO, ONT

LESTER B PEARSON INTL

**TORONTO/LESTER B. PEARSON INTERNATIONAL AIRPORT, ON (CYYZ)
CONSTRUCTION ACTIVITIES SPRING/SUMMER 2023 (CONTD 7) (SUP 16/23)**

Area 19 - Construction Activity T1 Apron - Phase 2

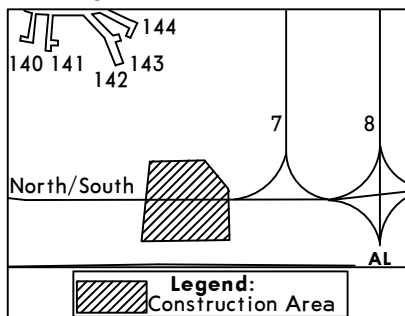

Dates: Mid-June 2023 to mid-July 2023

Scope: Apron Concrete Surface Rehabilitation

Impacts:

- North/South Taxilane between Taxilane 7 and Stand 141 **closed**
- Stand 142 **closed**
- Green centerline lighting **unavailable** on Terminal Perimeter Taxilane

Area 20 - Construction Activity T1 Apron - Phase 3

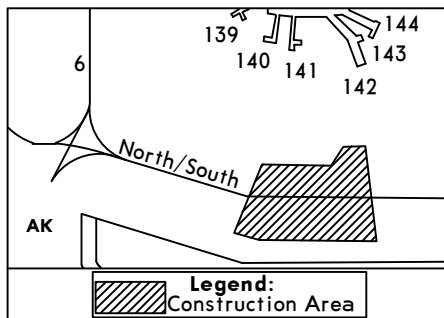

Dates: Mid July 2023 to late July 2023

Scope: Apron Concrete Surface Rehabilitation

Impacts:

- North/South Taxilane between Stand 142 and Stand 140 **closed**
- Stand 141 **closed**
- Green centerline lighting **unavailable** on Terminal Perimeter Taxilane

Area 21 - Construction Activity T1 Apron - Phase 4

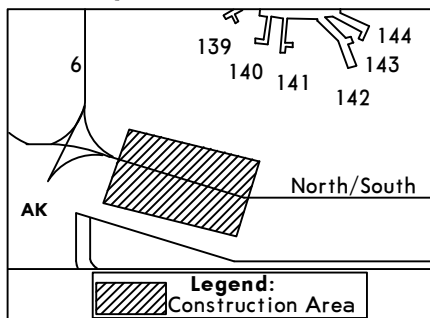

Dates: Mid-September 2023 to mid-October 2023

Scope: Apron Concrete Surface Rehabilitation

Impacts:

- North/South Taxilane between Taxilane 6 and Stand 141 **closed**
- Stand 140 **closed**
- Green centerline lighting **unavailable** on Terminal Perimeter Taxilane

CYYZ/YYZ

JEPPesen

TORONTO, ONT

28 APR 23 (10-8H)

LESTER B PEARSON INTL

**TORONTO/LESTER B. PEARSON INTERNATIONAL AIRPORT, ON (CYYZ)
CONSTRUCTION ACTIVITIES SPRING/SUMMER 2023 (CONTD 8) (SUP 16/23)**

Area 22 - Construction Activity Taxiway JC

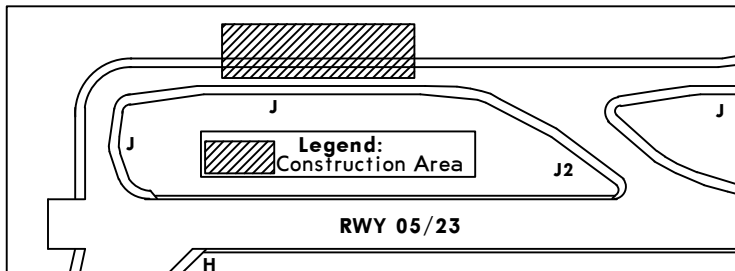

Dates: Early April 2023 to late July 2023

Scope: Taxiway surface and base construction

Impacts:

- Taxiway J between Runway 05 and Taxiway J2 **restricted** to Code C aircraft
- Taxiway J between Runway 05 and Taxiway J2 **closed**

Area 23 - Construction Activity Taxiway J

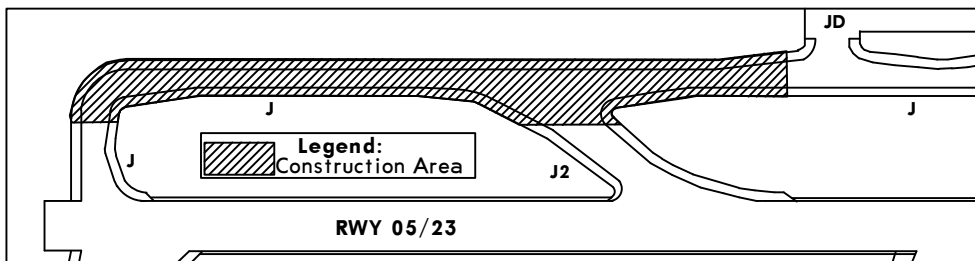

Dates: Mid-July 2023 to mid-August 2023

Scope: Taxiway surface rehabilitation

Impacts:

- Taxiway J between Runway 05 and Taxiway JD **closed**
- Taxiway J2 **closed**
- Runway 05/23 certification changed to non-instrument

CYYZ/YYZ
 Aft Elev **569'**
 M43.40.6 W079.37.8

JEPPESSEN
 28 APR 23 (10-9)

TORONTO, ONT
 LESTER B PEARSON INTL

D-ATIS		*TORONTO Clearance		APRON ADVISORY		TORONTO Departure	
D-ATIS	D-ATIS FDC	South Apron	North Apron	Pad Control	Apron Tow Coordinator		
120.825	133.1	122.075	122.275	131.175	131.95	136.525	
Ground		Tower		LONDON Radio			
121.9	121.65	119.1	118.35	118.7	123.275	128.8	127.575

RUNWAY INCURSION HOT SPOTS
 See AIRPORT INFO (CONTD)
 TAKE-OFF MINMS for description of Hot Spots

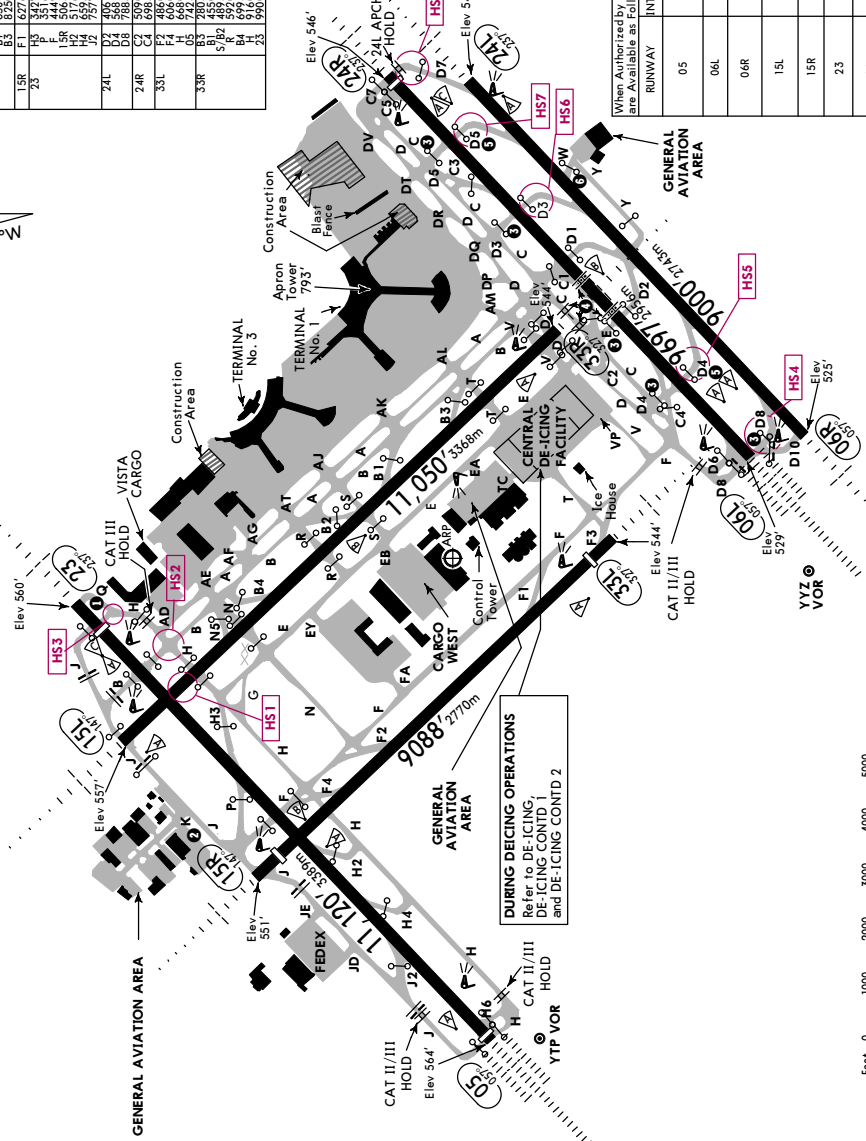

From	To	LDA	Preferred exit for med/heavy prop/transport	Preferred exit for transport
05	15R	5033	H3	H3
	F	5450	H3	H3
	H3	6670	H3	H3
	H4	6976	H3	H3
	H5	7483	C3	C1
	C1	4790	D3	D1
	C3	5482	D3	D1
	D3	7483	D3	D1
	H2	5176	H2	H2
	H4	5176	H2	H2
	H5	5579	H2	H2
	R	5119	B1	B1
	R	6154	B1	B1
	R	6250	B1	B1
	F1	6276	F1	F1
	F2	6276	F1	F1
	F4	6060	F4	F4
	F4	6060	F4	F4
	F4	6060	F4	F4
	B2	2800	B2	B2
	B4	4893	B4	B4
	B4	5920	B4	B4
	B4	9160	B4	B4
	B2	9900	B2	B2

OPERATIONAL NOTES
 CAUTION: Be alert to Rwy 06L/24R crossing clearances. Be prepared to stop short of Rwy 06L/24R. **Readback of all runway holding instructions is required.**
 A340-500/600, A350-900/1000, B777-300, and A380 discretionary oversteering required at all intersections.
 Design speed for Twys C2, B2, H3, D8, D4, D2, D1, D3, D5, and D7 is 50 kt (93 Kph). Design speed for Twys J2, F1, F2, F3, & F4 is 45 Kt (83 Kph). All other rapid exits designed for an exit speed of 35 Kt (65 Kph).
 Departures from holding bay inner centerlines Rwy 06L/D6, 24R/C5 and 05/H6 subtract 263' (80m) from declared distances.
 See APRON PROCs, PARKING GATES and TAXILANE LIMITATIONS for additional taxiway data and notes.
 While taxiing on Twy V (Pad 1) and Twy T (Pad 5) through the Central De-icing Facility strict adherence to the centerline is required. When in contact with ATC use Centerline. When in contact with Pad Control or Icmann, use assigned Lane. Pad 1 (Twy V) and Pad 5 (Twy T) Center Lane will accommodate aircraft with wingspans 264' (79.9m) and smaller. Aircraft with wingspans less than 118' (36m) may use North/South Lanes.

- 1 Normal Rwy 23 departures are from Twy H.
- Rwy 23 departures **do not enter Twy Q** without specific clearance from ATC.
- Aircraft requiring full length must notify Ground Control on initial contact.
- Twy K is uncontrolled and is restricted to acft with a wingspan of 135' (41.15m) (B757W) or less and an Aircraft Load Rating of 9.0 or less. Other aircraft may be authorized with prior approval from Ops.
- Discretionary oversteering required for aircraft with a wingspan of 124' (8757) or greater.
- Rwy 06L onto Twys E, D3 and D5.
- Rwy 24R onto Twys D3, E, D4, and D10/D8 southbound.
- Rwy 33 approach hold positions
- Twys D4, D5 south of Rwy 06L/24R: Angled runway hold positions in effect.
- Twys W & Y restricted to aircraft with wingspans less than 118' (36m).

WINGSPAN RESTRICTIONS
 Specific aircraft operations plan in effect for aircraft with wingspans 214' (65m) up to 262' (79.9m). Restrictions in place include:
 1. No holding short of Rwy 06L/24R after exit from Rwy 06R/24L.
 2. Aircraft (as defined above) operations on any parallel taxiway system, such as Alpha-Bravo or Charlie-Delta or Delta-Victor (Alpha to Echo), restrict operations on adjacent taxiway to aircraft with wingspans less than 118' (36m).
 3. Strict adherence to taxiway centerline is required all times.
 4. Discretionary over steering is required at all intersections.
 5. No taxiing on apron taxi lane between AJ and AK (between gates C31-C34).
 6. No taxiing on apron taxi lane between AJ and AT (between gates B15-B18).
 7. No turns from Twy E on Central De-icing Facility Pads 1 through 6.
 8. When aircraft on Central De-icing Facility taxi lane 5, Central De-icing Facility taxi lane 6 restricted to A320 or smaller (wingspan of 112' (34.1m)) and vice versa. The same applies to taxi lanes 7 and 8, and vice versa.
 9. No taxiing on Twy D between Twy D4 and Twy E.
 10. No taxiing on Twy B between Rwy 05/23 and Twy J.
 11. When aircraft taxiing within Holding Bays Rwy 06L/24R/05, adjacent parallel taxi lane restricted to aircraft with wingspans less than 118' (36m).
 12. Tow only authorized onto parking stands H1 and H6.

When Authorized by ATC, Intersection Departures are Available as Follows:

INTERSECTION	RUNWAY	RUNWAY	REMARKS
J2	H4	8120' (2475m)	
H4	H6	7129' (2173m)	
H6	H6	10512' (3204m)	
D4	D4	7763' (2364m)	
D8	D8	7883' (2403m)	
D4	D4	5682' (1732m)	
D8	D8	4401' (1341m)	
Y	Y	7766' (2367m)	
N	N	6841' (2085m)	
B4	B4	7270' (2216m)	
H	H	1653' (502m)	
B	B	9058' (2761m)	
D5	D5	7381' (2250m)	
W	W	6567' (2002m)	
D5	D5	7793' (2380m)	
C3	C3	6693' (2040m)	
F1	F1	6854' (2089m)	
V	V	10669' (3252m)	
T	T	9219' (2810m)	
B5	B5	8251' (2515m)	

CHANGES: Airport name, chart format.

State		I TAKE-OFF & DEPARTURE PROCEDURE	
Rwy 05		Rwy 06L	
Requires a minimum climb gradient of 360'/NM to 2700'. Fence to 575' MSL approximately 300' past departure end of runway, 550' right of runway centerline.		Requires a minimum climb gradient of 400'/NM to 2700'. Building to 612' MSL approximately 0.3 NM past departure end of runway, 1010' left of runway centerline.	
Authorized Air Carriers		Authorized Air Carriers	
HIRL & CL or RCLM	All Other Aircraft	HIRL & CL or RCLM	All Other Aircraft
TDZ RVR	R12 or V1/4	TDZ RVR	R12 or V1/4
Rollout or Mid RVR	R6	Rollout or Mid RVR	R6
A			
B			
C			
D			
Rwy 33R		Rwy 06R	
Climb heading 327° to 2100' before proceeding on course. Trees to 610' MSL approximately 0.3 NM past departure end of runway, 1000' right of runway centerline.		Requires a minimum climb gradient of 390'/NM to 2700'.	
Authorized Air Carriers		Authorized Air Carriers	
HIRL & CL or RCLM	All Other Aircraft	HIRL & CL or RCLM	All Other Aircraft
TDZ RVR	R12 or V1/4	TDZ RVR	R12 or V1/4
Rollout or Mid RVR	R6	Rollout or Mid RVR	R6
A			
B			
C			
D			
Rwy 15L		Rwy 15R	
Requires a minimum climb gradient of 390'/NM to 3000'. Tower to 655' MSL approximately 0.6 NM past departure end of runway, 1300' left of runway centerline.		Requires a minimum climb gradient of 380'/NM to 3000'.	
Authorized Air Carriers		Authorized Air Carriers	
HIRL & CL or RCLM	All Other Aircraft	HIRL & CL or RCLM	All Other Aircraft
TDZ RVR	R12 or V1/4	TDZ RVR	R12 or V1/4
Rollout or Mid RVR	R6	Rollout or Mid RVR	R6
A			
B			
C			
D			
Rwy 23		Rwy 24L	
Light poles to 609' MSL approximately 0.3 NM past departure end of runway, 450' right of runway centerline.		Requires a minimum climb gradient of 270'/NM to 1700'.	
Authorized Air Carriers		Authorized Air Carriers	
HIRL & CL or RCLM	All Other Aircraft	HIRL & CL or RCLM	All Other Aircraft
TDZ RVR	R12 or V1/4	TDZ RVR	R12 or V1/4
Rollout or Mid RVR	R6	Rollout or Mid RVR	R6
A			
B			
C			
D			
Rwy 24R		Rwy 33L	
Requires a minimum climb gradient of 260'/NM to 1700'.		Requires a minimum climb gradient of 250'/NM to 900'. Buildings to 607' MSL approximately 0.3 NM past departure end of runway, 1000' left of runway centerline.	
Authorized Air Carriers		Authorized Air Carriers	
HIRL & CL or RCLM	All Other Aircraft	HIRL & CL or RCLM	All Other Aircraft
TDZ RVR	R12 or V1/4	TDZ RVR	R12 or V1/4
Rollout or Mid RVR	R6	Rollout or Mid RVR	R6
A			
B			
C			
D			

I DEPARTURE CLIMB RATE V/V (FPM)										
GROUND SPEED	90	120	140	160	180	200	250	300		
250'/NM	380	500	590	670	750	840	1050	1250		
260'/NM	390	520	610	700	780	870	1090	1300		
270'/NM	410	540	630	720	810	900	1130	1350		
360'/NM	540	720	840	960	1080	1200	1500	1800		
380'/NM	570	760	890	1020	1140	1270	1590	1900		
390'/NM	590	780	910	1040	1170	1300	1630	1950		
400'/NM	600	800	940	1070	1200	1340	1670	2000		

GENERAL		ADDITIONAL RUNWAY INFORMATION	
Multilateration: Pilots must keep their transponder on at all times when maneuvering on the airport, turned on prior to brake release and on arrival, on until final engine shutdown. Pilots that do not have a transponder code issued by ATC must squawk 1000 when taxiing.			
USABLE LENGTHS			
LANDING BEYOND		LAHSO Distance	
THRESHOLD	TAKE-OFF	THRESHOLD	TAKE-OFF
05	10,985' 3348m	10,775' 3284m	200' 61m
23	10,434' 3180m		
① Angle 3.0°. For aircraft with eye-to-wheel height up to 45'.			
② LDA: 10,640' 3243m			
③ LDA: 10,089' 3075m			
06R			
HIRL CL SSALR	④ PAPI-L	RVR	197' 60m
		8898'	
		2712m	
④ Angle 3.0°. For aircraft with eye-to-wheel height up to 45'.			
⑤ LDA: 8898' 2712m			
06L			
HIRL CL ALSF-II TDZ	⑥ PAPI-L	RVR	197' 60m
		9500'	
		2896m	
		9589'	
		2923m	
⑥ Angle 3.0°. For aircraft with eye-to-wheel height up to 45'.			
⑦ LDA 9392' 2863m			
15R			
HIRL SSALR	⑧ PAPI-R	RVR	197' 60m
		8500'	
		2591m	
		7449'	
		2270m	
⑧ Angle 3.0°. For aircraft with eye-to-wheel height up to 45'.			
⑨ LDA: 8490' 2588m			
15L			
HIRL CL SSALR	⑩ PAPI-L	RVR	200' 61m
		10,249'	
		3124m	
		10,120'	
		3085m	
⑩ Angle 3.0°. For aircraft with eye-to-wheel height up to 45'.			
⑪ LDA: 10,886' 3318m			
<p>RUNWAY INCURSION HOT SPOTS </p> <p>For information only, not to be construed as ATC instructions.</p> <p>HS4 to HS8 - Short distance between parallel runways. Manage your taxi speed. Expect to hold short of parallel runway.</p> <p>HS1 Taxiing northbound on Rwy 33R aircraft fail to hold short of and incur on Rwy 05/23.</p> <p>HS2 Taxiing northbound on Twy B aircraft miss turn onto Twy H and incur on Rwy 05/23.</p> <p>HS3 Taxiing eastbound on Twy H aircraft continue onto Twy Q and incur on Rwy 23.</p> <p>HS4 Exiting Rwy 24L onto Twy D8 aircraft fail to hold short of and incur on Rwy 06L/24R.</p> <p>HS5 Exiting Rwy 24L onto Twy D4 aircraft fail to hold short of and incur on Rwy 06L/24R.</p> <p>Note: Angled runway hold position in effect on Twy D4 south of and incur on Rwy 06L/24R.</p> <p>HS6 Exiting Rwy 06R onto Twy D3 aircraft fail to hold short of and incur on Rwy 06L/24R.</p> <p>HS7 Exiting Rwy 06R onto Twy D5 aircraft fail to hold short of and incur on Rwy 06L/24R.</p> <p>Note: Angled runway hold position in effect on Twy D5 south of and incur on Rwy 06L/24R.</p> <p>HS8 Taxiing southbound on Twy D7 aircraft fail to hold short of the 24L approach hold line and incur on Rwy 06R/24L.</p>			

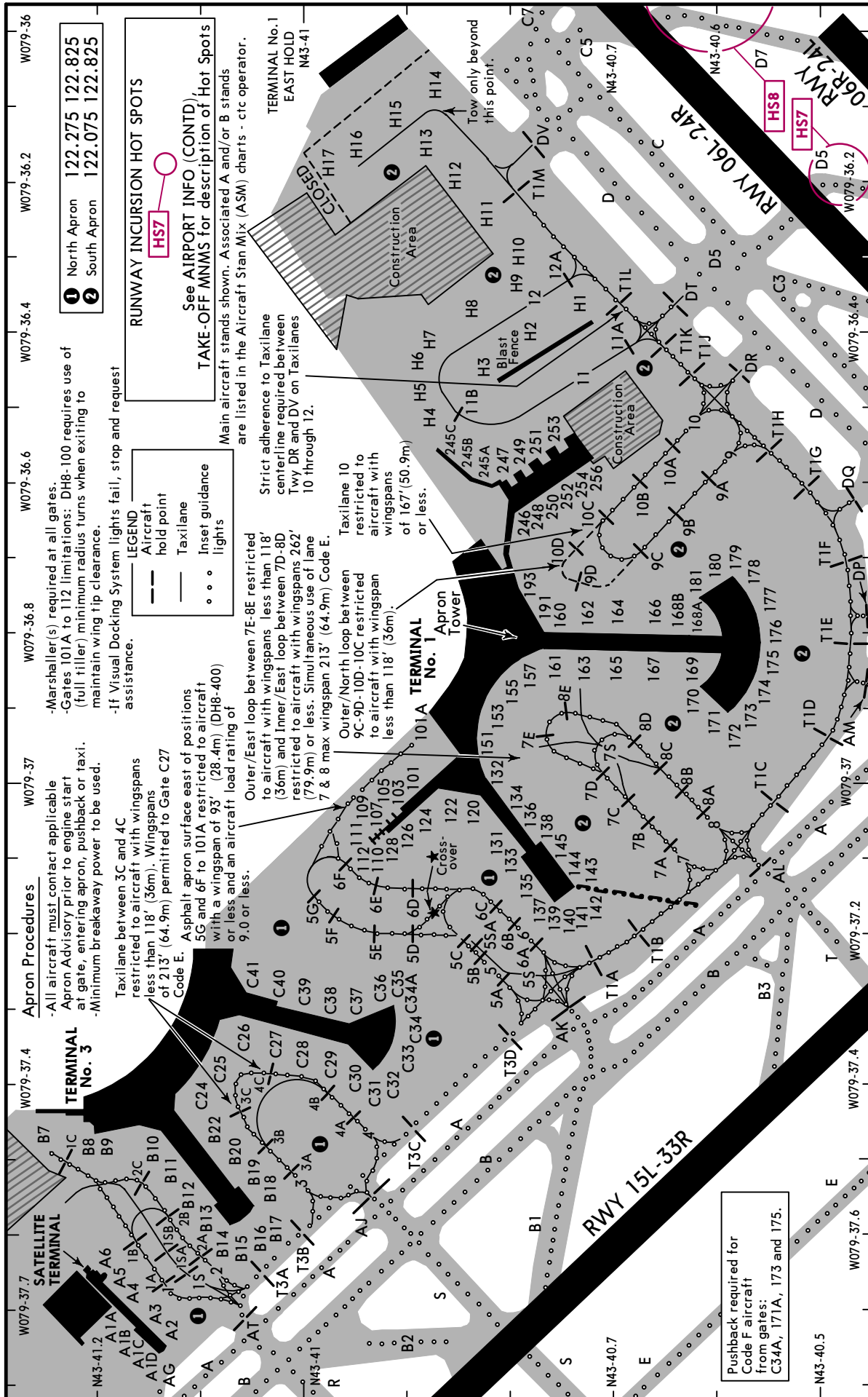

North Apron	122.275	122.825
South Apron	122.075	122.825

RUNWAY INCURSION HOT SPOTS
 See AIRPORT INFO (CONITD), TAKE-OFF MNMS for description of Hot Spots
 Main aircraft stands shown. Associated A and/or B stands are listed in the Aircraft Stan Mix (ASM) charts - ctc operator.

LEGEND
 - - - - - Aircraft hold point
 ——— Taxilane
 Inset guidance lights

- Apron Procedures**
- All aircraft must contact applicable Apron Advisory prior to engine start at gate, entering apron, pushback or taxi.
 - Minimum breakaway power to be used.
 - Marshaller(s) required at all gates.
 - Gates 101A to 112 limitations: DH8-100 requires use of (full tiller) minimum radius turns when exiting to maintain wing tip clearance.
 - If Visual Docking System lights fail, stop and request assistance.

Taxilane between 3C and 4C restricted to aircraft with wingspans less than 118' (36m). Wingspans of 213' (64.9m) permitted to Gate C27 Code E.
 Asphalt apron surface east of positions 5G and 6F to 101A restricted to aircraft with a wingspan of 93' (28.4m) (DH8-400) or less, and an aircraft load rating of 9.0 or less.
 Outer/East loop between 7E-8E restricted to aircraft with wingspans less than 118' (36m) and Inner/East loop between 7D-8D restricted to aircraft with wingspans 262' (79.9m) or less. Simultaneous use of lane 7 & 8 max wingspan 213' (64.9m) Code E.
 Outer/North loop between 9C-9D-10D-10C restricted to aircraft with wingspan less than 118' (36m).
 Taxilane 10 restricted to aircraft with wingspans of 167'(50.9m) or less.

Pushback required for Code F aircraft from gates: C34A, 171A, 173 and 175.

CYYZ/YYZ



TORONTO, ONT
LESTER B PEARSON INTL

TAXILANE LIMITATIONS				
Taxilane	Taxilane Segment	Aircraft Code/ Limitation	Max Wingspan	Comments
Pier A North	Between AG and Gate A1A	DH8-400	93' (28.4m)	
1	Between AT & Stand B8	C	118' (36m)	
	Between Stand B8 & Stand B7D	DH8-400	93' (28.4m)	
1S	Between AT and Hangar	E	213' (65m)	
2	Between AT and Hangar	D	170' (51.9m)	
	Between 2D & Stand B8	C	118' (36m)	
1/2	1B/2B Radius	C	118' (36m)	
3	Between AJ & 3B	C	118' (36m)	Code E to Stand C29 & C27
	Between 3B & 3C	C	118' (36m)	Code E to Stand C29 & C27
4	Between AJ & 4B	C	118' (36m)	Code E to Stand C29 & C27
	Between 4B & 4C	C	118' (36m)	Code E to Stand C29 & C27
3/4	3B/4B Radius	D	170' (51.9m)	
	3C/4C Radius	C	118' (36m)	
N/S	Between AT & AK	E	213' (65m)	
5	Between AK & 5E	E	213' (65m)	AK to 5D closed when Lane 5S in use
	Between 5E & 5G	D	170' (51.9m)	AK to 5D closed when Lane 5S in use
5-6	Crossover	E	213' (65m)	Closed when Lane 5S in use
6	Between AK & 6C	E	213' (65m)	Code E allowed to Stand 124 AK to 6C closed when Lane 5S in use
	Between 6C & 6D	C	118' (36m)	Code E allowed to Stand 124 No code E push tail East onto Lane 6 from Stand 124.
	Between 6D & 6F	C	118' (36m)	
	Between 6F & Gate 101	DH8-400	93' (28.4m)	
5/6	5C/6C Radius	E	213' (65m)	No B777 due to Jet Blast Closed when Lane 5S in use
	5G/6F Radius	C	118' (36m)	Closed when Lane 5S in use
5S	Between AK & Stand C35	F	262' (79.9m)	A380 only. Strict Adherence to C/L. Closes Lane 5A-5D. Lane 6 between 6A and 6C closed, remainder of Lane 6 restricted to Code C or smaller.
7	Between AL & 7D	F	262' (79.9m)	Simultaneous use of lane 7 & 8 max span 213' (64.9m) Code E
	Between 7D & 7E	C	118' (36m)	
8	Between AL & 8D	F	262' (79.9m)	Simultaneous use of lane 7 & 8 max span 213' (64.9m) Code E
	Between 8D & 8E	C	118' (36m)	
7/8	7D/8D Radius	F	262' (79.9m)	
	7E/8E Radius	C	118' (36m)	

CYYZ/YYZ



28 APR 23 10-9B2

TORONTO, ONT
LESTER B PEARSON INTL

TAXILANE LIMITATIONS

Taxilane	Taxilane Segment	Aircraft Code/ Limitation	Max Wingspan	Comments
7S	Between 7C & 7S	E	213' (65m)	
	Between 8C & 7S	E	213' (65m)	
	Between 7S & 151	E	213' (65m)	No 77W/773 Closes Taxilane 7 & 8 beyond 7C/8C
	Between 7S & 161A	E	213' (65m)	Closes Taxilane 7 & 8 beyond 7C/8C
N/S	Between AK & AM	F	262' (79.9m)	
9	Between DR & 9C	E	213' (65m)	
	Between 9C & 9D	C	118' (36m)	
10	Between DR & 10C	D	170' (51.9m)	
	Between 10C & 10D	C	118' (36m)	
9/10	9C/10C Radius	D	170' (51.9m)	
	9D/10D Radius	C	118' (36m)	
E/W	Between AM & DV	F	262' (79.9m)	Strict adherence to C/L
11	Between DT & H4	E	213' (65m)	Strict adherence to C/L
12	Between H1/H10 & H4	E	213' (65m)	Strict adherence to C/L
E/W	Between DV & H12B	E	213' (65m)	
E/W/N/S	Between H12B & H17	E	213' (65m)	Tow Operations Only

CYYZ/YYZ

JEPPESEN

TORONTO, ONT

28 APR 23 10-9C

LESTER B PEARSON INTL

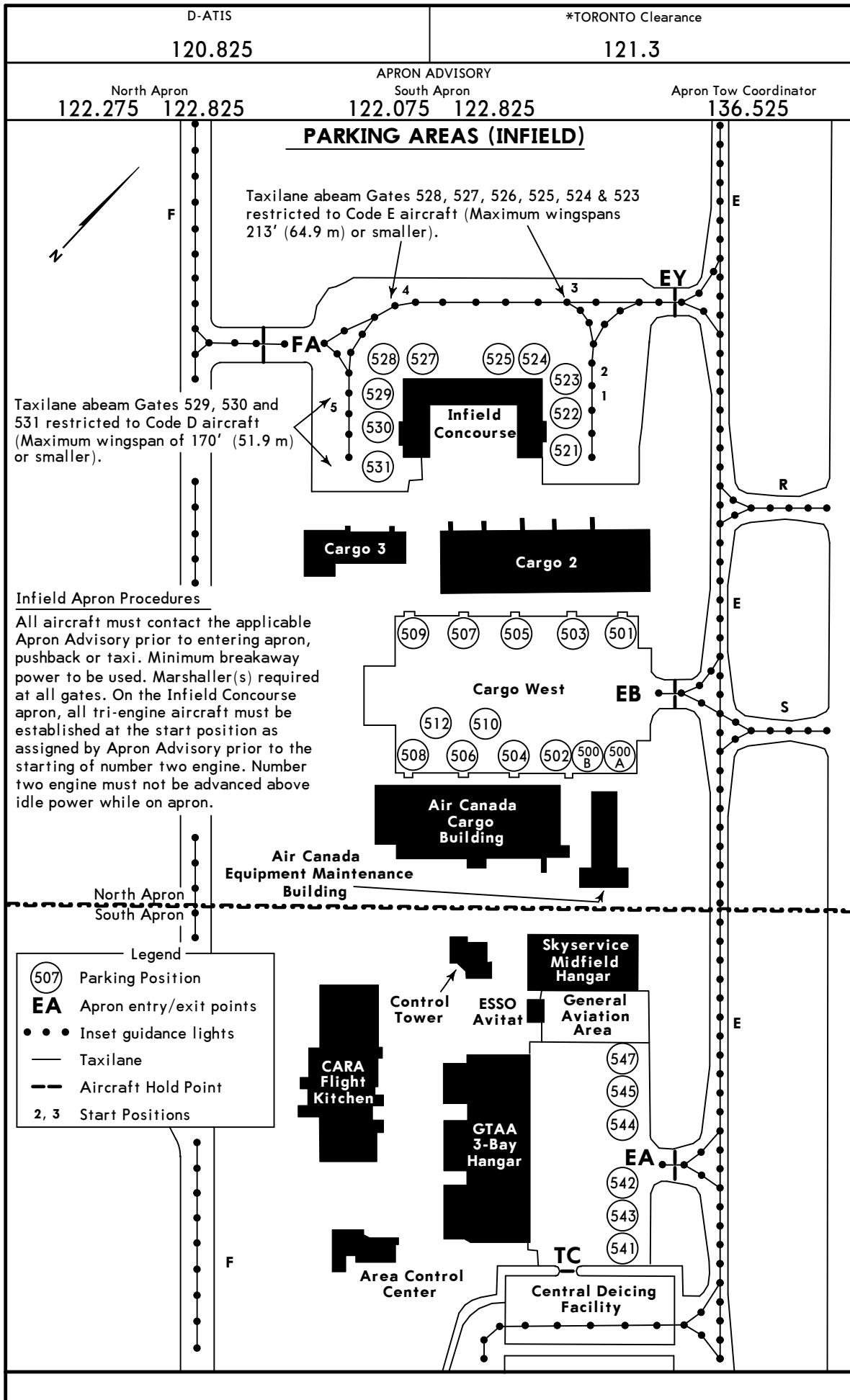

CYYZ/YYZ

JEPPESEN

TORONTO, ONT

28 APR 23

10-9D

LESTER B PEARSON INTL

COMMUTER PARKING AREAS

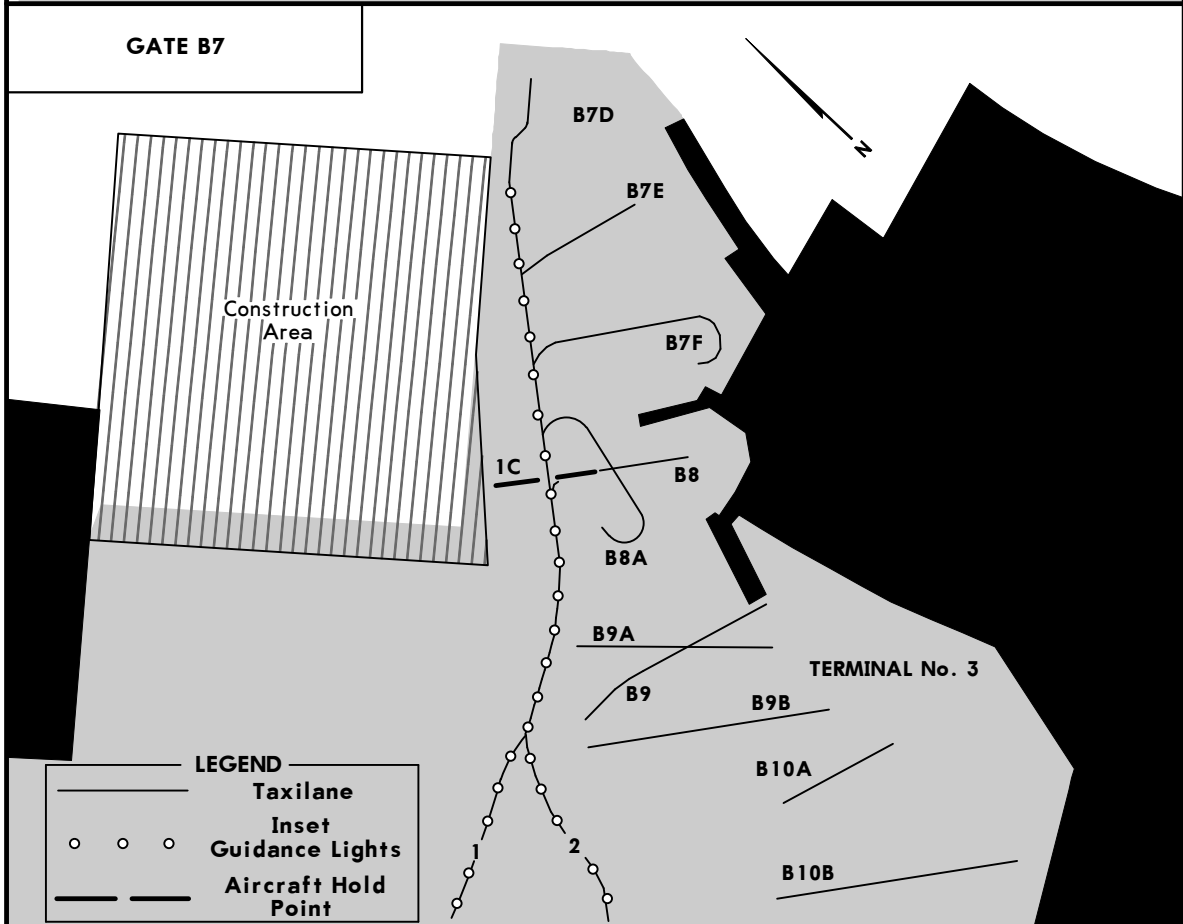
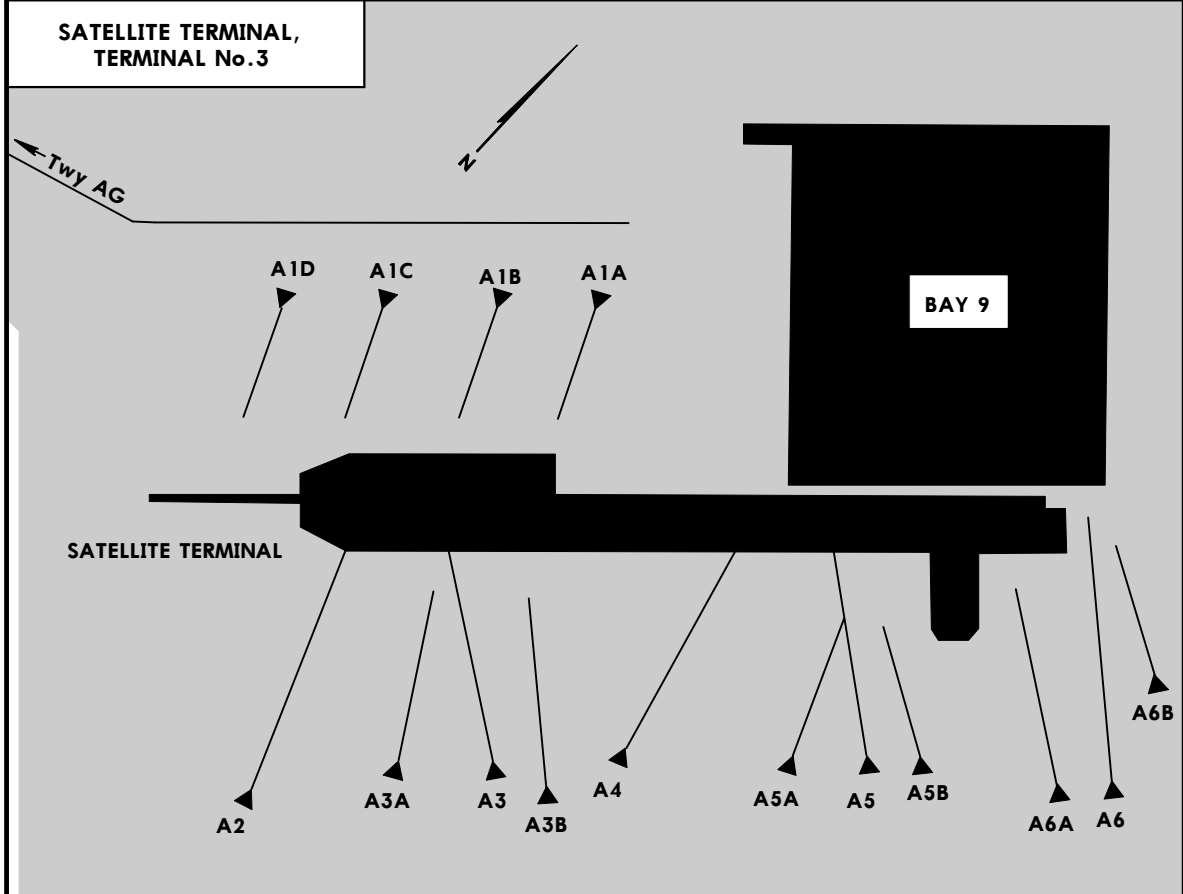

CYYZ/YYZ



TORONTO, ONT

28 APR 23 (10-9D1)

LESTER B PEARSON INTL

PARKING POSITION COORDINATES			
POSITION No.	COORDINATES	POSITION No.	COORDINATES
SATELLITE TERMINAL			
A1A, A1B	N43 41.2 W079 37.6	250	N43 40.8 W079 36.6
A1C, A1D	N43 41.2 W079 37.7	251	N43 40.8 W079 36.4
A2	N43 41.1 W079 37.7	252	N43 40.7 W079 36.6
A3A thru A6B	N43 41.2 W079 37.7	253	N43 40.8 W079 36.4
		254	N43 40.7 W079 36.6
TERMINAL No. 1		256	N43 40.7 W079 36.6
101	N43 40.9 W079 37.0	TERMINAL No. 3	
101A	N43 40.9 W079 36.9	B7, B8, B9	N43 41.2 W079 37.5
103, 105, 107, 109	N43 40.9 W079 37.0	B10A thru B12	N43 41.1 W079 37.5
110 thru 112	N43 40.9 W079 37.1	B13 thru B15	N43 41.1 W079 37.6
120	N43 40.8 W079 37.0	B16, B17	N43 41.0 W079 37.6
		B18, B19	N43 41.0 W079 37.5
122, 124	N43 40.9 W079 37.0	B20, B22	N43 41.1 W079 37.5
126, 128	N43 40.9 W079 37.1	C24, C25	N43 41.1 W079 37.4
131	N43 40.8 W079 37.1	C26	N43 41.1 W079 37.3
132	N43 40.8 W079 37.0	C27	N43 41.0 W079 37.3
133	N43 40.8 W079 37.1	C28 thru C30	N43 41.0 W079 37.4
134	N43 40.8 W079 37.0	C31 thru C33	N43 40.9 W079 37.4
135	N43 40.8 W079 37.1	C34	N43 40.9 W079 37.3
136	N43 40.8 W079 37.0	C34A	N43 40.9 W079 37.2
137	N43 40.8 W079 37.2	C35, C36	N43 40.9 W079 37.3
138	N43 40.8 W079 37.1	C37 thru C40	N43 41.0 W079 37.3
139	N43 40.8 W079 37.2	C41	N43 41.1 W079 37.3
140, 141	N43 40.7 W079 37.2	OTHER	
142 thru 144	N43 40.7 W079 37.1	H1 thru H3	N43 40.8 W079 36.3
145	N43 40.8 W079 37.1	H4 thru H6	N43 40.9 W079 36.4
151, 153, 155	N43 40.8 W079 36.9	H7 thru H8	N43 40.9 W079 36.3
157, 160, 161, 191	N43 40.8 W079 36.8	H9	N43 40.9 W079 36.2
162 thru 167	N43 40.7 W079 36.8	H10	N43 40.8 W079 36.2
168A	N43 40.7 W079 36.6	H11 thru H13	N43 40.9 W079 36.1
168B	N43 40.7 W079 36.7	H14	N43 40.9 W079 36.0
169	N43 40.6 W079 36.8	H15 thru H16	N43 41.0 W079 36.0
170 thru 174	N43 40.6 W079 36.9	H17	N43 41.0 W079 36.1
175, 176	N43 40.5 W079 36.8		
177	N43 40.6 W079 36.8		
178 thru 181	N43 40.6 W079 36.7		
193	N43 40.8 W079 36.7		
245A thru 245C	N43 40.9 W079 36.5		
246	N43 40.8 W079 36.6		
247	N43 40.8 W079 36.5		
248	N43 40.8 W079 36.6		
249	N43 40.8 W079 36.5		

(INFIELD) PARKING POSITION COORDINATES

POSITION No.	COORDINATES	POSITION No.	COORDINATES
PARKING AREAS (INFIELD)			
500A, 500B	N43 40.7 W079 37.8	510, 512	N43 40.6 W079 37.9
501	N43 40.8 W079 37.8	521	N43 40.9 W079 38.0
502	N43 40.7 W079 37.8	522 thru 524	N43 40.9 W079 38.1
503	N43 40.7 W079 37.9	525	N43 40.9 W079 38.2
504	N43 40.6 W079 37.8	527 thru 529	N43 40.8 W079 38.3
505	N43 40.7 W079 37.9	530, 531	N43 40.8 W079 38.2
506	N43 40.6 W079 37.8	541	N43 40.4 W079 37.5
507	N43 40.7 W079 38.0	542	N43 40.5 W079 37.5
508	N43 40.6 W079 37.9	543	N43 40.4 W079 37.5
509	N43 40.7 W079 38.0	544	N43 40.5 W079 37.5
		545, 547	N43 40.5 W079 37.6

CYYZ/YYZ



TORONTO, ONT

LESTER B PEARSON INTL

28 APR 23

10-9E

LOW VISIBILITY TAXI CHART

LESS THAN RVR 1200 TO 600

LAND RWY 05, DEPART RWY 05
For Low Visibility Procedures See LOW VIS PROCS

D-ATIS 120.825 133.1	Data comm: D-ATIS PDC	*TORONTO Clearance 121.3	North Apron 122.275	South Apron 122.075	APRON ADVISORY Pad Control 131.175 131.95	Apron Tow Coordinator 136.525
Ground 121.9 121.65 119.1		Tower 118.35 118.7		TORONTO Departure 127.575 128.8		

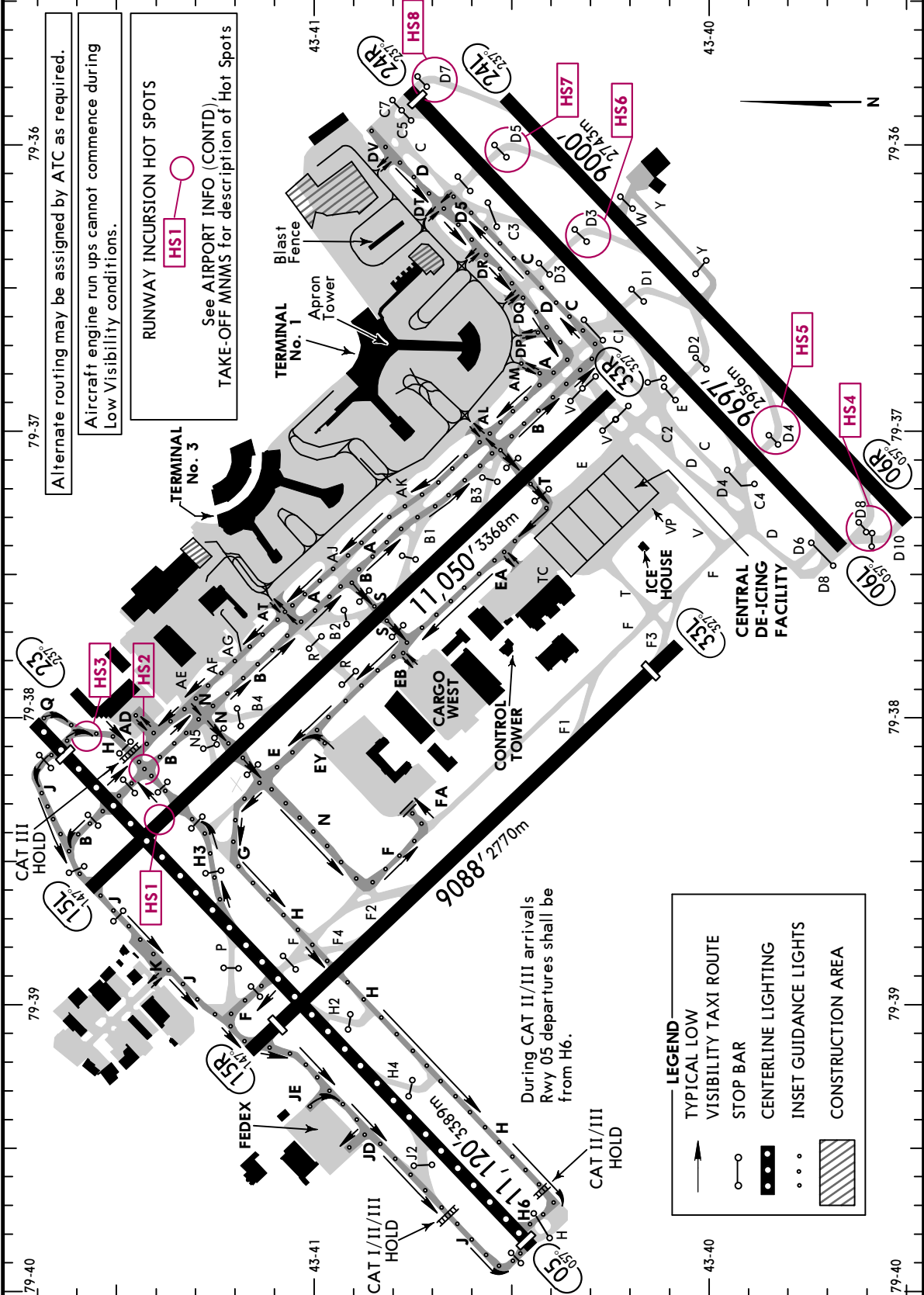

Alternate routing may be assigned by ATC as required.
Aircraft engine run ups cannot commence during Low Visibility conditions.

RUNWAY INCURSION HOT SPOTS
See AIRPORT INFO (CONTD), TAKE-OFF MNMS for description of Hot Spots

During CAT II/III arrivals Rwy 05 departures shall be from H6.

LEGEND

- TYPICAL LOW VISIBILITY TAXI ROUTE (indicated by a solid line with arrows)
- STOP BAR (indicated by a circle with a horizontal bar)
- CENTERLINE LIGHTING (indicated by a solid line with dots)
- INSET GUIDANCE LIGHTS (indicated by a dashed line with dots)
- CONSTRUCTION AREA (indicated by a hatched rectangle)

CYYZ/YYZ



TORONTO, ONT

LESTER B PEARSON INTL

28 APR 23 10-9F

LOW VISIBILITY TAXI CHART

LAND RWY 06L, DEPART RWY 06L

LESS THAN RVR 1200 TO 600

For Low Visibility Procedures See LOW VIS PROCS

D-ATIS 120.825 133.1	Data comm: D-ATIS PDC	*TORONTO Clearance 121.3	North Apron 122.275	South Apron 122.075	APRON ADVISORY Pad Control 131.175 131.95	Apron Tow Coordinator 136.525
Ground 121.9 121.65 119.1		Tower 118.35 118.7		TORONTO Departure 127.575 128.8		

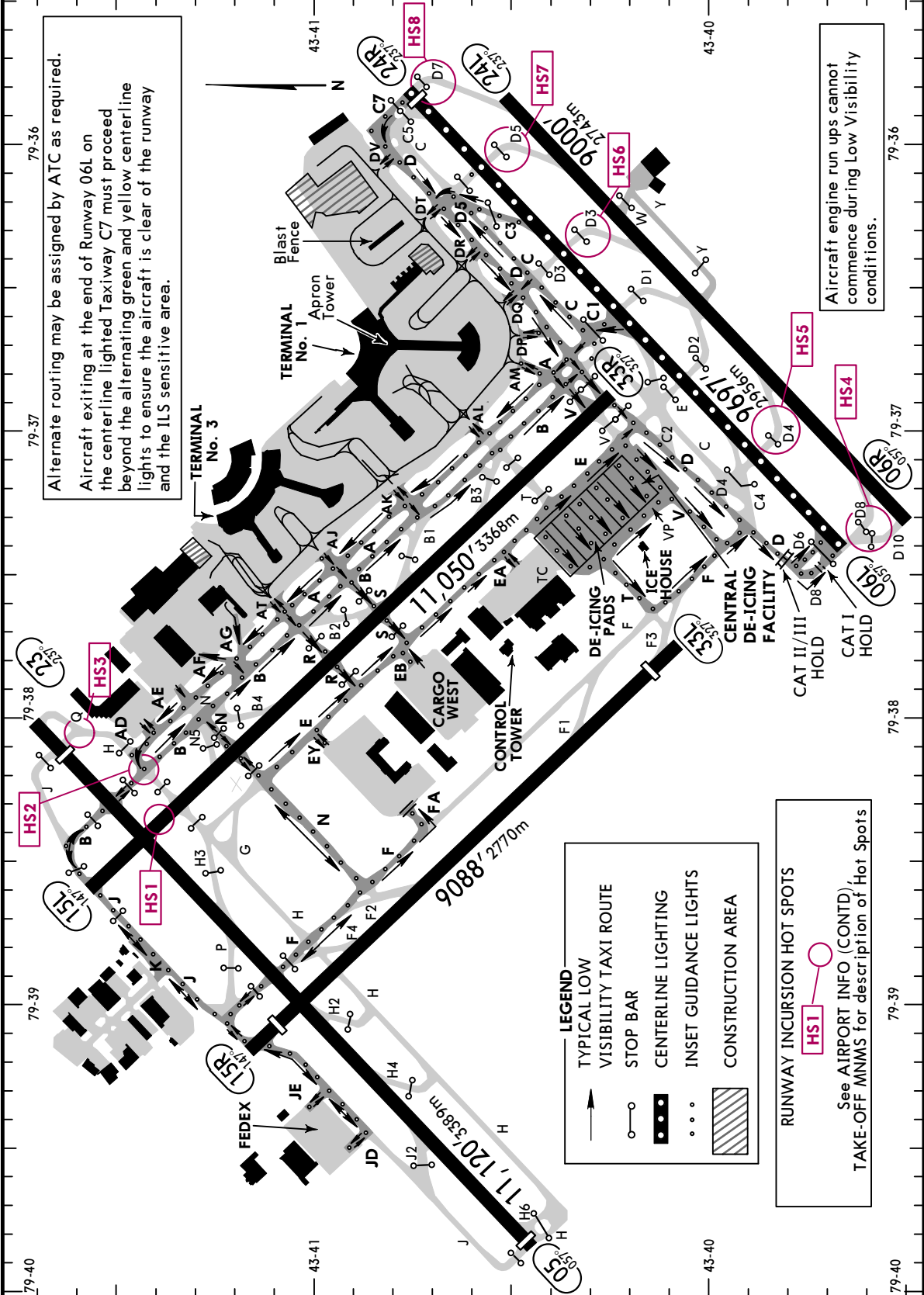

Alternate routing may be assigned by ATC as required.
Aircraft exiting at the end of Runway 06L on the centerline lighted Taxiway C7 must proceed beyond the alternating green and yellow centerline lights to ensure the aircraft is clear of the runway and the ILS sensitive area.

Aircraft engine run ups cannot commence during Low Visibility conditions.

LEGEND

- TYPICAL LOW VISIBILITY TAXI ROUTE
- STOP BAR
- CENTERLINE LIGHTING
- INSET GUIDANCE LIGHTS
- CONSTRUCTION AREA

RUNWAY INCURSION HOT SPOTS
See AIRPORT INFO (CONTD), TAKE-OFF MNMS for description of Hot Spots

CYYZ/YYZ



TORONTO, ONT

LESTER B PEARSON INTL

28 APR 23 (10-9F1)

LOW VISIBILITY TAXI CHART

LESS THAN RVR 1200 TO 600

LAND RWY 06L, DEPART RWY 33R

For Low Visibility Procedures See LOW VIS PROCS

D-ATIS 120.825 133.1	Data comm: D-ATIS PDC	*TORONTO Clearance 121.3	North Apron 122.275	South Apron 122.075	APRON ADVISORY Pad Control 131.175 131.95	Apron Tow Coordinator 136.525
Ground 121.9 121.65 119.1		Tower 118.35 118.7		TORONTO Departure 127.575 128.8		

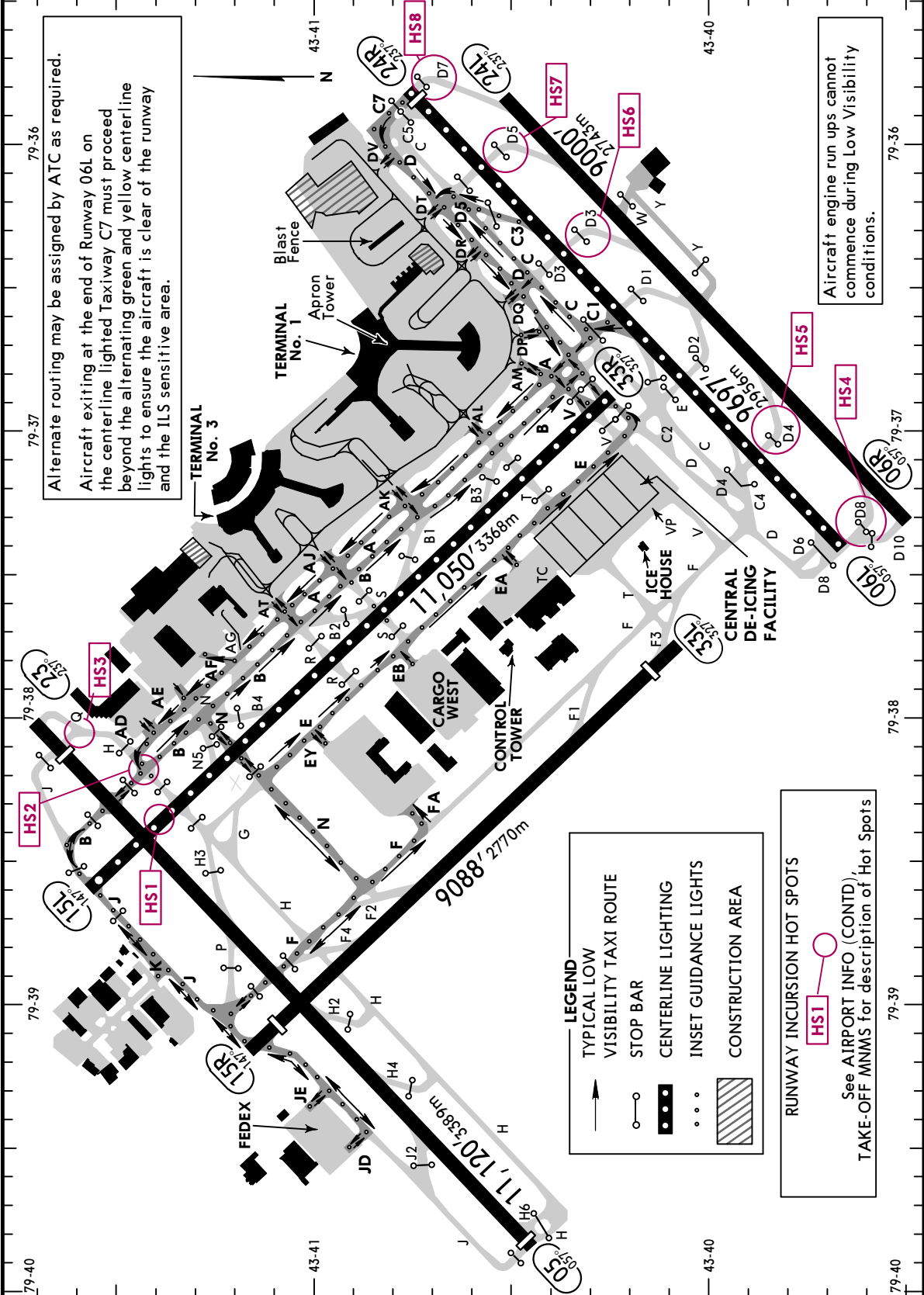

CHANGES: Airport name, inset guidance lights added.

CYYZ/YYZ



 28 APR 23 (10-9G)
TORONTO, ONT
LESTER B PEARSON INTL**LOW VISIBILITY PROCEDURES (RVR less than 1200 to 600 FT)****APPLICATION**

These procedures apply to ground movements of aircraft arriving and departing under low visibility conditions. Arrivals and departures below RVR 600 are not authorized. When weather conditions indicate visibility below RVR 1200 is imminent, procedures will be implemented restricting aircraft and vehicle operations on the movement area. The following message will be added to the ATIS broadcast:

'LOW VISIBILITY PROCEDURES IN EFFECT'**GENERAL****Low Visibility Taxi Routes**

Typical taxi routes are shown on the Low Visibility Taxi Charts. Taxiway surfaces are painted with enhanced yellow and black centerline markings. In addition, Taxiways A, C, F, H, J, M, N, T, P, R, S, V, E, D, B, T1, and T3 aprons are equipped with green centerline lights. Yellow in-set taxiway intersection lights that consist of three lights spaced 1.5m apart at 90 degrees to the direction of travel are located at taxiway/taxiway intersections and apron entry/exit points coincident with lighted location signs. Aircraft may be directed to hold or report by any of these positions.

Airport Surface Detection Equipment (ASDE)

Ground radar is used to monitor the position of aircraft operating on the maneuvering area. In the event of an ASDE failure, ATC may suspend, restrict or terminate low visibility operations.

DEPARTURES

When low visibility procedures are in effect the Departure runways are 05, 06L and 33R. Intersection take-offs from 06L are not authorized. Intersection take-offs on 33R from Victor Taxiway and on 05 from H6 may be assigned by ATC.

Sequencing of Aircraft Ground Movements for Take-off

Do not request start, push back or call for taxi clearance until the reported RVR is greater than:

<u>Aircraft/Pilot Take-off Minima</u>	<u>Minimum RVR for Start</u>
1200 RVR	1000 RVR
600 RVR	600 RVR

Stop Bar/Guard Light System

Each taxiway entrance onto Runways 05, 06L and 33R is equipped with a stop bar consisting of red in-set lights and red elevated lights located at the taxi holding position. Yellow flashing runway guard lights (wig-wags) are installed at each end of the stop bar. When the red stop bar lights are illuminated, green lead on lights beyond the stop bar are extinguished. When ATC issues a clearance to proceed onto the runway, the red stop bar lights will be extinguished and the green lead on lights beyond the stop bar will be illuminated. The stop bar is reset automatically as the aircraft moves onto the runway.

'AT NO TIME SHALL A PILOT CROSS AN ILLUMINATED RED STOP BAR'**ARRIVALS**

When low visibility procedures are in effect the Arrival runways are 05 and 06L. For 05, approved exits are Taxiways F (northbound), H3, B, H/J and Q. For 06L approved exits are Taxiways C1, C3 and C7. Aircraft exiting either runway must proceed beyond the alternating green and yellow centerline lights to ensure the aircraft is clear of the runway and the ILS sensitive area.

CYYZ/YYZ

TORONTO, ONT
LESTER B PEARSON INTL**DE-ICING PROCEDURE****CENTRAL DE-ICING FACILITY (CDF)**

The CDF and associated taxiways from transfer points ICE 1 - ICE 6 are operated and controlled by the Greater Toronto Airports Authority (GTAA) Deicing Operations. For more information, contact (416) 776-3423.

All Air-to-Ground communication is via VHF radio (no interphone connection).

Upon entry to the Deicing Bay, Flight Crew must advise of any specific de/anti-icing check and/or treatment requirements, including the following:

Tactile check; under wing and/or undercarriage inspection or deicing; propeller deicing; engine inlet inspection; etc.

Flight Crew shall advise their de/anti-icing requirements.

Type I fluid available: Dow Chemical UCAR ADF Concentrate (dilute).

Type IV fluid available: Dow Chemical UCAR Endurance EG106 (100/0).

Flight Crew will be advised of the fluid type(s) in use ("mode").

When in "Type I mode", SAE AMS1424/1 Type I will be applied.

When in "Type IV mode", Type I followed by SAE AMS1428/1 Type IV fluid will be applied.

Flight Crew must request any deviation to the fluid "mode".

When in "Type I mode", should the Flight Crew determine holdover is required, Flight Crew shall advise "TYPE I HOLDOVER REQUIRED".

When Type IV anti-icing treatment is required/requested, by default fluid will be applied to the upper wing and horizontal stabilizer surfaces. Type IV fluid will only be applied to the vertical stabilizer, wing tip devices (where equipped) and/or fuselage when requested by the Flight Crew.

To expedite overall deicing process, if able, aircraft should be configured for deicing on approach to the Central De-Icing Facility. Flight Crew should configure aircraft for an engines-on deicing procedure, unless advised otherwise by PAD CONTROL or ICEMAN.

AUTOMATED PROCEDURES**ENTRY PROCEDURE - PAD CONTROL - 131.175**

1. Prior to departing Parking Position, contact Clearance Delivery/Apron/Ground (as applicable) and advise, "AIRCRAFT DE-ICING REQUIRED".
2. Ground will provide taxi instructions to Central De-Icing Facility entry transfer point ICE (#).
3. When approaching the Central De-Icing Facility entry point, Ground will advise the Flight Crew to contact/monitor PAD CONTROL on 131.175.
4. PAD CONTROL will normally instruct the Flight Crew to:
 - a. "HOLD POSITION AT (e.g. ICE 1)"; or
 - b. "TAXI/PROCEED INTO STAGING BAY # (e.g. 3C) AND CONTACT ICEMAN ON 131.375 or 129.625 (as applicable) ENTERING THE BAY."
5. After receiving taxi clearance from PAD CONTROL, proceed into assigned Staging Bay following the appropriate inset lights/lead-in lines. An automated Visual Guidance Display System (VGDS) will provide correct flight number, rate of closure and stopping information.
6. Entering the Staging Bay, contact ICEMAN and proceed following the VGDS instructions.

CAUTION: AIRCRAFT SHALL NOT ENTER THE DEICING BAY UNTIL INSTRUCTED TO DO SO BY ICEMAN.

PROCEDURE - ICEMAN - 131.375 or 129.625

7. ICEMAN will provide:
 - a) Taxi clearance into the Staging Bay only:
ICEMAN will issue taxi instructions in the assigned Staging Bay to the specific stop point in the Bay.
 - b) Taxi clearance directly into the Deicing Bay:
ICEMAN will issue instructions for taxi to the assigned deicing position in the Deicing Bay, including the mode of guidance (VGDS) and the requirement to report "BRAKES SET, AIRCRAFT CONFIGURED AND DEICING REQUIREMENTS."

Note: Deicing equipment may be positioned in a temporary Safe Zone on the Center lane within the Deicing Bay when aircraft are assigned to the North or South lanes.

8. Once aircraft is in the final stop position, brakes are set and aircraft configured for de/anti-icing, contact ICEMAN on the appropriate frequency e.g., "ICEMAN, ABC123 IN BAY 2 NORTH, BRAKES SET, AIRCRAFT CONFIGURED, READY TO DEICE".
9. ICEMAN will advise "HOLD POSITION, DEICING BEGINS NOW, CONTINUE TO MONITOR THE SIGNBOARD ON YOUR (LEFT/RIGHT)."

CAUTION: DURING THE DEICING PROCESS, THRUST SETTING MUST NOT EXCEED GROUND IDLE AND/OR PROPELLERS MUST REMAIN FEATHERED AT ALL TIMES.

10. On completion of the de/anti-icing operation, ICEMAN will contact Flight Crew to advise "DEICING COMPLETE, (DEICING/ANTI-ICING FLUID TYPE(S) APPLIED and MIXTURE RATIO (for Type IV fluid only)), ANTI-ICING BEGAN AT (local time) POSTDEICING/ANTI-ICING CHECK COMPLETE, EQUIPMENT SAFELY AWAY, HOLD POSITION AND CONTACT PAD CONTROL ON 131.175 FOR TAXI".

Note: "POSTDEICING/ANTI-ICING CHECK COMPLETE" means as per Flight Crew's specific request for deicing services and that the post deicing/anti-icing check has been completed. Where Type IV fluid is applied, the fluid brand and mixture ratio is: Dow Chemical UCAR Endurance EG106 (100/0).

Note: Where deicing only is performed, including symmetrical spot deicing and/or deicing of specific aircraft sections only, as no holdover applies in these circumstances, a holdover start time will not be provided. ICEMAN will advise "HOLDOVER TIMES DO NOT APPLY".

CYYZ/YYZ



 28 APR 23 (10-9J)

 TORONTO, ONT
 LESTER B PEARSON INTL

CAUTION: DO NOT MOVE AIRCRAFT UNTIL TAXI CLEARANCE HAS BEEN RECEIVED FROM PAD CONTROL.

CAUTION: ENGINE RUN-UPS WILL ONLY BE APPROVED BY PAD CONTROL OR ICEMAN WHEN OPERATIONS PERMIT AND WHEN SAFE TO DO SO. ENGINE RUN-UPS ARE PROHIBITED ON TAXILANE 1. ENGINE FAN BLADE ICE SHEDDING RUN-UPS ARE PROHIBITED AT THE CDF.

EXIT PROCEDURE - PAD CONTROL 131.175

11. When ready to taxi contact PAD CONTROL and advise "ABC123 READY TO TAXI".
12. PAD CONTROL will issue VISUAL (VGDS displaying "EXIT NOW"), and VERBAL exit instructions to the Central De-Icing Facility exit point.

CAUTION: DO NOT MOVE AIRCRAFT UNTIL PAD CONTROL GIVES BOTH VERBAL AND VISUAL TAXI CLEARANCE.

Note: In the event of a complete VGDS failure, only verbal instructions will be provided.

13. At exit point, hold short and contact Ground (on frequency as advised by PAD CONTROL) for further taxi clearance.

Note: All inset lights may be illuminated during times of darkness or lowered visibility, regardless of taxi instructions.

MANUAL PROCEDURES

In the event that the VGDS, Hold Lights, and/or Inset Lights are inoperative; and/or the Lead-In Line and/or Aircraft Stop Line are obscured and not visible to the Flight Crew, the Central De-Icing Facility may deploy a "Follow Me" Vehicle as a secondary guidance system.

MANUAL ENTRY PROCEDURE - PAD CONTROL - 131.175

Follow steps 1 through 4 in the Automated Procedures.

5. After receiving taxi clearance from PAD CONTROL, proceed into assigned Staging Bay following the appropriate inset lights/lead-in lines.

No exchange of deicing information is necessary at this stage KEEP RT BRIEF AND AVOID FREQUENCY CONGESTION.

6. Entering the Staging Bay, contact ICEMAN and proceed into the assigned Staging Bay following the appropriate inset guidance lights/lead-in line as assigned.

CAUTION: AIRCRAFT SHALL NOT ENTER THE DEICING BAY UNTIL INSTRUCTED TO DO SO BY ICEMAN.

7. ICEMAN will provide:

- a) Taxi clearance into the Staging Bay only:

ICEMAN will issue taxi instructions in the assigned Staging Bay to the specific stop point, indicated by an Aircraft Stop Line; blue flashing Staging Beacon; and/or other visual reference point as specified by ICEMAN.

- b) Taxi clearance directly into the Deicing Bay:

ICEMAN will issue instructions for taxi to the assigned deicing position in the Deicing Bay, including the mode of guidance (Aircraft Stop Line or "Follow Me" Vehicle) and the requirement to report "BRAKES SET, AIRCRAFT CONFIGURED AND DEICING REQUIREMENTS".

Note: In the event that the VGDS, Hold Lights, and/or Inset Lights are inoperative; and/or the Lead-In Line and/or Aircraft Stop Line are obscured and not visible to the Flight Crew, the Central De-Icing Facility may deploy a "Follow Me" Vehicle as a secondary guidance system.

Note: Deicing equipment may be positioned in a temporary Safe Zone on the Center lane within the Deicing Bay when aircraft are assigned to the North or South lanes.

8. Once aircraft is in the final stop position, brakes are set and aircraft configured for de/anti-icing, contact ICEMAN on the appropriate frequency e.g., "ICEMAN, ABC123 IN BAY 2 NORTH, BRAKES SET, AIRCRAFT CONFIGURED, READY TO DEICE". Aircraft will be held at the deicing position by a signboard displaying "STOP" and/or red hold lights until deicing is completed. Should a "Follow Me" Vehicle be used, the "Follow Me" Vehicle will turn off all lights and return to the Safe Zone.
9. ICEMAN will advise "HOLD POSITION, DEICING BEGINS NOW, CONTINUE TO MONITOR THE SIGNBOARD ON YOUR (LEFT/RIGHT)."

VGDS PARTIAL FAILURE

Once aircraft has been guided into and stopped in the appropriate Deicing Bay, the aircraft will be held by a signboard displaying "STOP" and/or red hold lights until deicing is completed.

VGDS COMPLETE FAILURE

Once aircraft has been guided into and stopped in the appropriate Deicing Bay, a "Follow Me" Vehicle with the signaling system configured with RED signal lights ON, or a "Positive Hold Vehicle" without signboard/signaling system shall position on the lead-in-line in front of the aircraft and hold in line-of sight of the Flight Deck. CONTINUE TO HOLD POSITION AND DO NOT MOVE.

CAUTION: DURING THE DEICING PROCESS, THRUST SETTING MUST NOT EXCEED GROUND IDLE AND/OR PROPELLERS MUST REMAIN FEATHERED AT ALL TIMES.

Continue with steps 10 through 13 in the Automated Procedures.

CYYZ/YYZ

JEPPESEN
28 APR 23 10-9K

TORONTO, ONT
LESTER B PEARSON INTL

Should a "Follow Me" Vehicle and/or "Positive Hold" Vehicle be used, after the above occurs, the "Follow me" Vehicle shall extinguish all signal lights and return to the designated "Safe Zone" OR the "Positive Hold" Vehicle shall return to the designated "Safe Zone".

SIGNBOARD DISPLAYS



AUTOMATED VISUAL GUIDANCE & DISPLAY SYSTEM SEQUENCING

Aircraft Entering Directly into a Deicing Bay (No Staging)

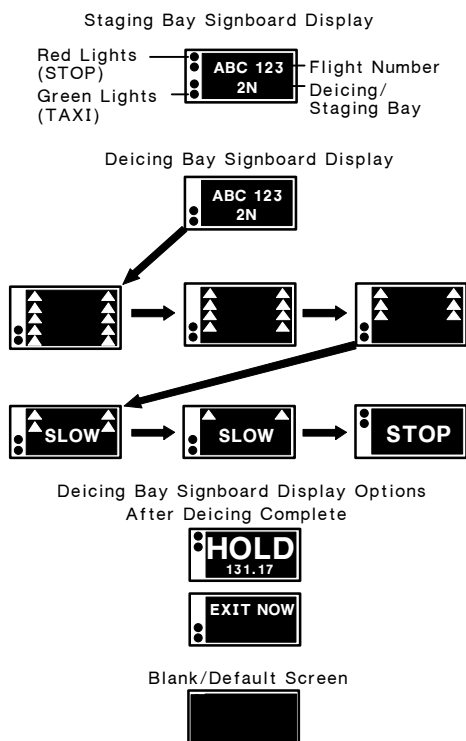

Aircraft Stopped in the Staging and Deicing Bay

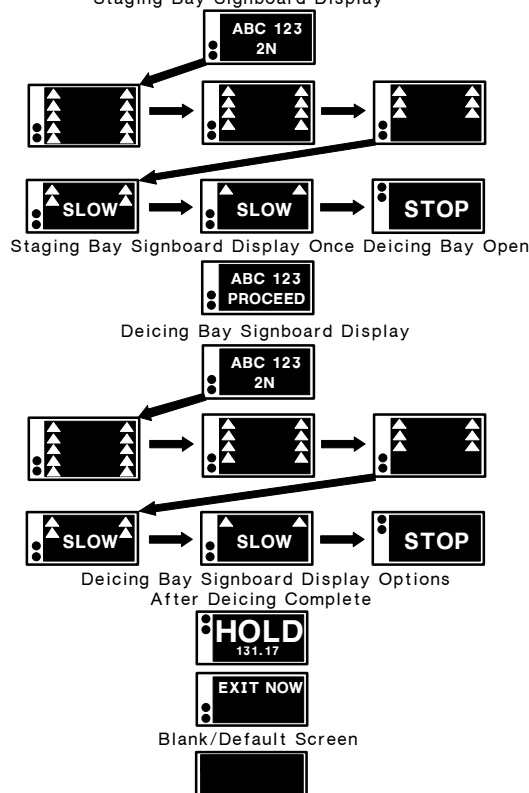

CENTRAL DE-ICING FACILITY (CDF)

Pad Control	Iceman	Ground
131.175 131.95	129.625 131.375	119.1 121.65 121.9

Specific aircraft operations plan in effect for aircraft with wingspans 214' (65m) up to 262' (79.9m).

Restrictions in place include:

1. For Central De-Icing Facility operations, no turns from Twy E into any of the de-icing pads are permitted. The only taxi routes permitted for de-icing are via Twy T into Pad 5 and via Twy V into Pad 1.

Pads 1 & 5:

Center lane will accommodate all aircraft. Aircraft with wingspans less than 118' (36m) may use North/South Lanes.

Pads 2, 3, 4 & 6:

Center lanes will accommodate aircraft with wingspans 213' (64.9m) and smaller. Aircraft with wingspans less than 118' (36m) may use North/South Lanes.

Aircraft shall not manoeuvre on equipment safe zone surfaces between Pads delineated by RED equipment restraint lines.

LEGEND

- ↖ Line of sight to controlling VGDS
- N North Lane
- C Center Lane
- S South Lane
- HOLD LINE
- | Aircraft Stop Line
- ◆ Staging Beacon
- ICE 1 SIGNBOARD

Central De-Icing Facility shown with aircraft entering from east to west, the staging bays are the gray areas.

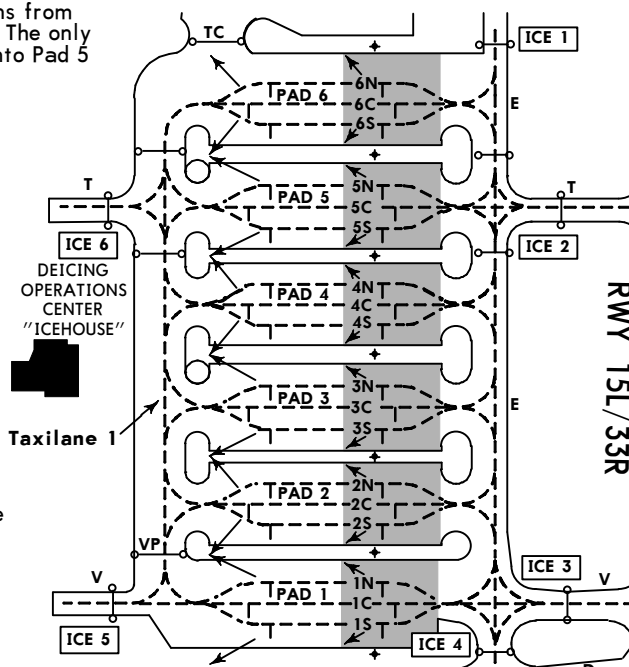

CYYZ/YYZ



TORONTO, ONT
LESTER B PEARSON INTL

ENGINE FAN BLADE ICE SHEDDING PROCEDURES

Single engine taxi operations should not be used during contaminated airfield conditions or when operations require the crossing of active runways. This will enhance safety and reduce the likelihood of engine inlet contamination during active precipitation, while eliminating any requirement to conduct engine-start activities on the airfield.

The completion of aircraft engine run-up for engine fan blade ice shedding must be conducted on taxiway areas outlined in the next chart diagrams. Strict adherence to the centerline is mandatory during engine fan blade ice shedding. Proper coordination with air traffic control (ATC) (Clearance, ground, or tower) is required.

On initial contact with Clearance (121.3 MHz), flight crews shall advise:

- Deicing requirements
- Run-up requirement prior to take-off
- Duration of run-up (if required)

Subsequently, if engine run-up requirements change, flight crews shall notify ATC as soon as practicable. The Airport Authority will ensure engine fan blade ice shedding areas in use are inspected and treated as required. Should taxiway surface conditions make engine run-up unsafe, flight crews shall coordinate with ATC to have the run-up conducted at the take-off position.

DEPARTING RUNWAY	ICE SHED AREA	ENGINE FAN BLADE ICE SHEDDING AREA
	IS	
06L or 06R	IS1	Taxiway F between Taxiway T and Taxiway V
	IS2	Taxiway D at the Runway 06L CAT II/III hold line
	IS6	Taxiway B between Taxiway T and Taxiway V
	IS11	Taxiway D between Runway 33R approach hold line and Taxiway A
24R or 24L	IS3	Taxiway D between Taxiway D3 and Taxiway D5
	IS6	Taxiway B between Taxiway T and Taxiway V
	IS11	Taxiway D between Runway 33R approach hold line and Taxiway A
	IS12	Taxiway C between Taxiway D3 and Taxiway C3
23	IS4	Taxiway A between Taxiway AE and Taxiway H
	IS8	Taxiway F between Taxiway N and Taxiway FA
	IS9	Taxiway N between Taxiway F and Taxiway E
05	IS1	Taxiway F between Taxiway T and Taxiway V
	IS5	Taxiway H between Taxiway H4 and Runway 05 CAT III hold line
	IS8	Taxiway F between Taxiway N and Taxiway FA
	IS9	Taxiway N between Taxiway F and Taxiway E
	IS10	Taxiway H between Taxiway H2 and Taxiway H4
33R	IS1	Taxiway F between Taxiway T and Taxiway V
	IS6	Taxiway B between Taxiway T and Taxiway V
	IS11	Taxiway D between Runway 33R approach hold line and Taxiway A
	IS13	Taxiway V holding short of Taxiway E (west side)
33L	IS1	Taxiway F between Taxiway T and Taxiway V
15L	IS4	Taxiway A between Taxiway AE and Taxiway H
	IS7	Taxiway F between Runway 05/23 and Taxiway J
	IS9	Taxiway N between Taxiway F and Taxiway E
15R	IS7	Taxiway F between Runway 05/23 and Taxiway J
	IS8	Taxiway F between Taxiway N and Taxiway FA
	IS9	Taxiway N between Taxiway F and Taxiway E

CYYZ/YYZ

28 APR 23 **JEPPESEN** (10-9M)

TORONTO, ONT

LESTER B PEARSON INTL

ENGINE FAN BLADE ICE SHEDDING DIAGRAMS

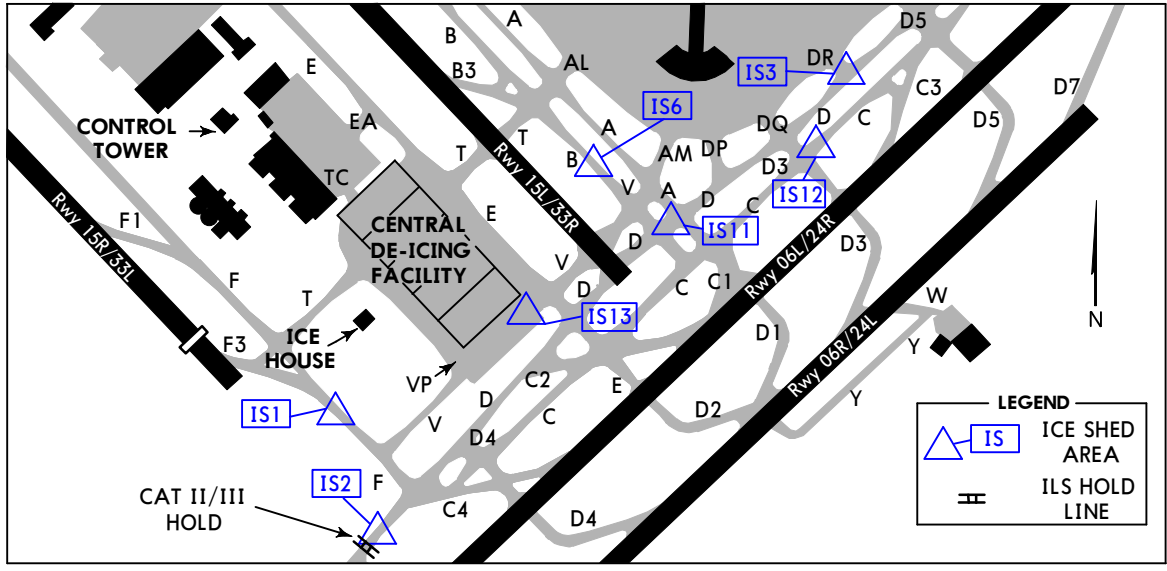
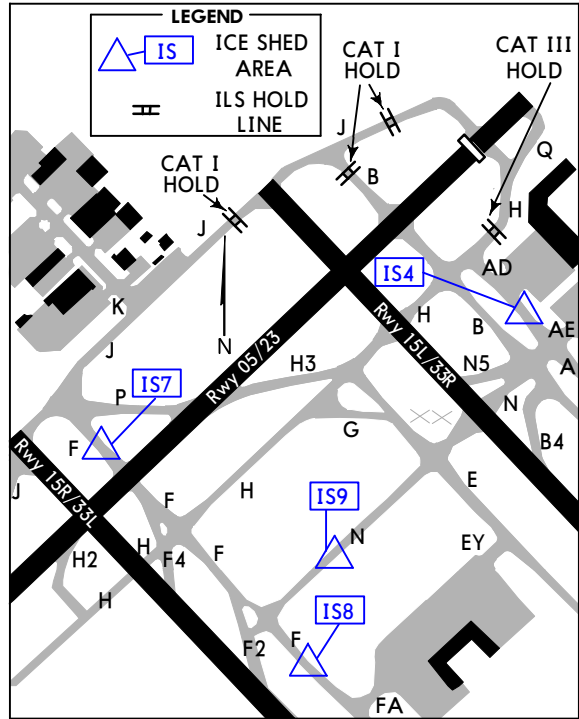
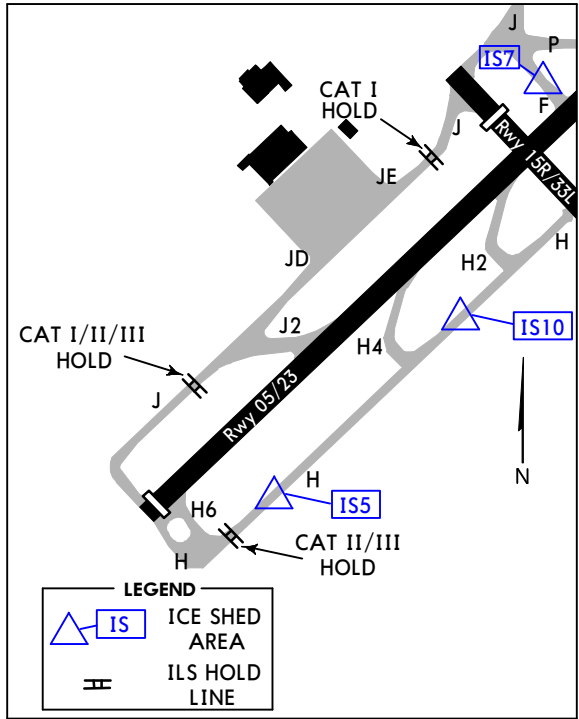

CYYZ/YYZ LESTER B PEARSON INTL

JEPPESSEN
28 APR 23 **(11-1)**

TORONTO, ONT ILS Rwy 05

D-ATIS 120.825 133.1	LONDON Radio 123.275	TORONTO Arrival 132.8 124.475 125.4			TORONTO Tower 118.35 118.7	Ground 121.9 121.65 119.1
LOC ITX 109.7	Final Apch Crs 057°	GS KERPU 2020' (1456')	ILS DME DA(H) Refer to Minimums	Apt Elev 569' TDZE 564'	<p>MSA YYZ VOR</p>	
MISSED APCH: Climb to 1100' heading 057°. Then climbing LEFT turn to 3000' to intercept outbound YYZ VOR R-013 to AVTEK						
Alt Set: INCHES		Trans level: FL180		Trans alt: 18000'		
1. Radar required. 2. SAFE ALTITUDE WITHIN 100 NM 4900'. 3. Simultaneous approach authorized with Rwy 06L or 06R. 4. LOC reliable only within 10° either side of centerline. 5. Procedure turn not authorized.						

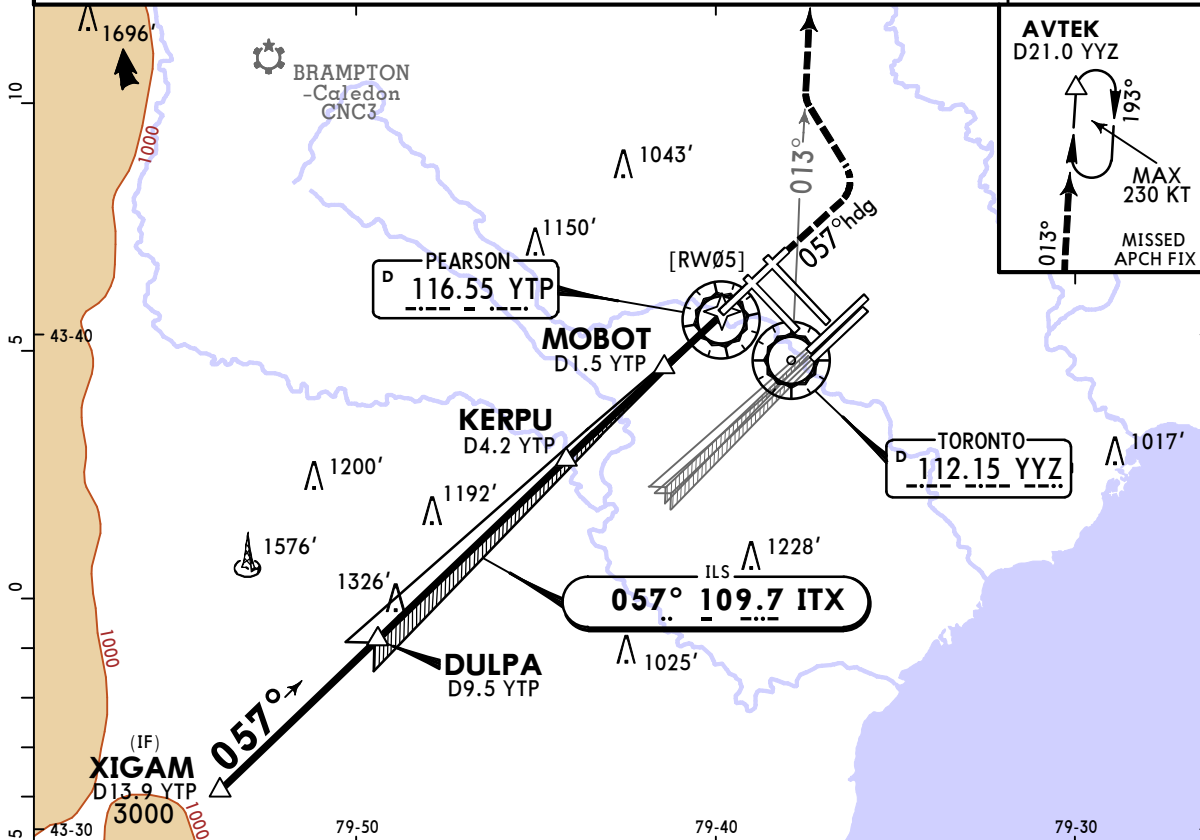

NM to YTP DME	13.9	12.0	11.0	10.0	9.0	8.0	7.4	6.0	5.0	4.0	3.0	2.0	1.0
VDA ALTITUDE	5080'	4480'	4160'	3840'	3520'	3200'	3000'	2570'	2250'	1930'	1610'	1290'	980'

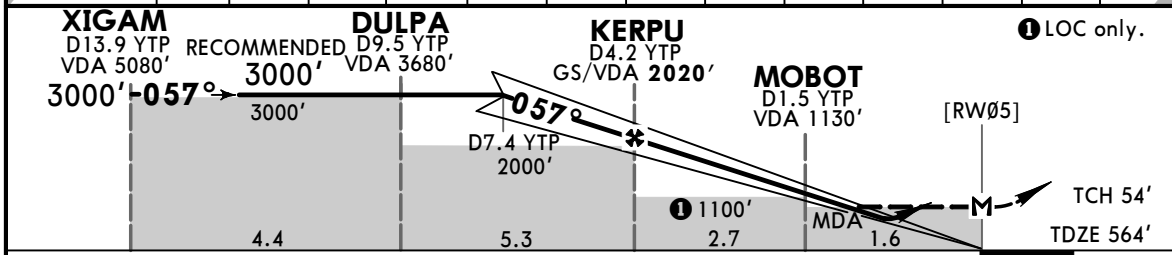

Gnd speed-Kts	70	90	100	120	140	160	ALSF-II PAPI	1100'	057° hdg	3000'	YYZ 112.15 R-013
GS/VDA	3.00°	372	478	531	637	849					
KERPU to MAP	4.3	3:41	2:52	2:35	2:09	1:51	1:37				

State				STRAIGHT-IN LANDING				
ILS DME		LOC (GS out) DME		ILS DME		LOC (GS out) DME		
DA(H) 764' (200')		DA(H) 814' (250')		MDA(H) 980' (416')		MDA(H) 980' (416')		
FULL		HIALS out		FULL		HIALS out		
A								
B								
C	R26 or V1/2		R50 or V1		R50 or V1		V1 1/4	
D								

CYYZ/YYZ LESTER B PEARSON INTL

JEPPESSEN
28 APR 23 **(11-1A)**

TORONTO, ONT
ILS CAT II or III Rwy 05

D-ATIS	LONDON Radio	TORONTO Arrival			TORONTO Tower		Ground		
120.825 133.1	123.275	132.8	124.475	125.4	118.35	118.7	121.9	121.65	119.1

BRIEFING STRIP™

LOC ITX 109.7	Final Apch Crs 057°	GS KERPU 2020' (1456')	CAT IIIC NA	CAT IIIB NA	CAT IIIA Refer to Minimums	CAT II RA 108' DA(H) 664'(101')	Apt Elev 569' TDZE 564'
----------------------------	----------------------------------	--	----------------	----------------	----------------------------------	---	----------------------------------

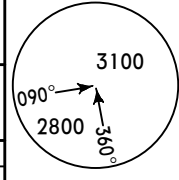

MISSED APCH: Climb to 1100' heading 057°. Then climbing LEFT turn to 3000' to intercept outbound YYZ VOR R-013 to AVTEK.

Alt Set: INCHES Trans level: FL180 Trans alt: 18000'
 1. Radar required. 2. SAFE ALTITUDE WITHIN 100 NM 4900'. 3. PRIOR AUTHORIZATION REQUIRED FROM TRANSPORT CANADA. 4. Simultaneous approach authorized with Rwy 06L or 06R. 5. LOC reliable only within 10° either side of centerline. 6. Procedure turn not authorized.

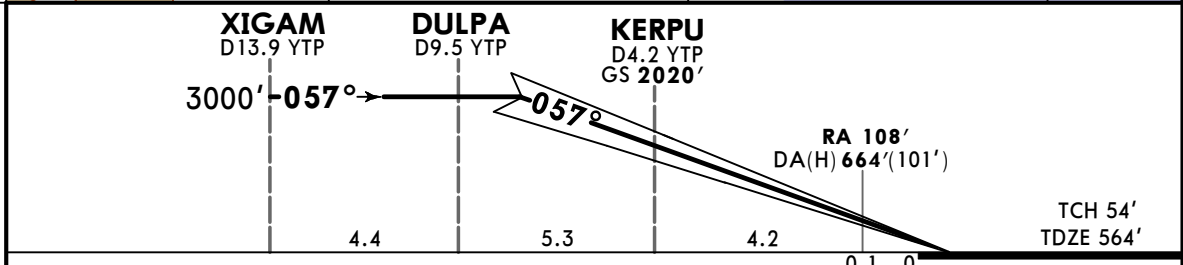
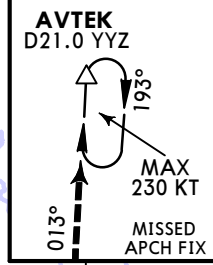
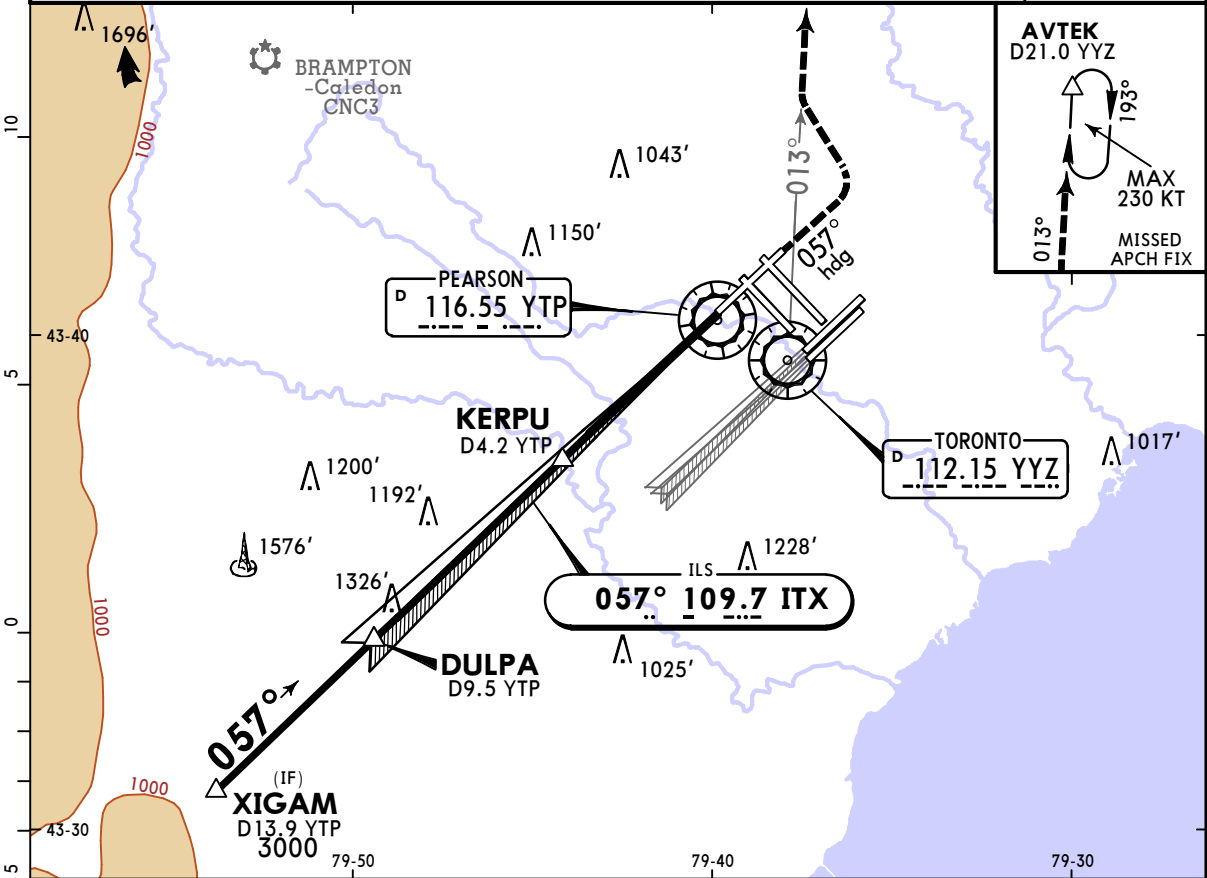

Gnd speed-Kts	70	90	100	120	140	160	ALSF-II PAPI	1100'	057° hdg	3000'	YYZ 112.15 R-013
GS	3.00°	372	478	531	637	743					

State				STRAIGHT-IN LANDING			
CAT IIIC ILS		CAT IIIB ILS		CAT IIIA ILS		CAT II ILS RA 108' DA(H) 664' (101')	
NOT AUTHORIZED		NOT AUTHORIZED		R6		R12	

CYYZ/YYZ
LESTER B PEARSON INTL



TORONTO, ONT
ILS Rwy 06L

D-ATIS 120.825 133.1	LONDON Radio 123.275	TORONTO Arrival 132.8 124.475 125.4			TORONTO Tower 118.35 118.7	Ground 121.9 121.65 119.1
LOC IJS 109.1	Final Apch Crs 057°	GS VEPNA 2010' (1475')	ILS DME DA(H) Refer to Minimums	Apt Elev 569' TDZE 535'		
MISSED APCH: Climb to 1100' heading 057°. Climbing RIGHT turn to 3100' heading 132°. Then intercept outbound YYZ VOR R-102 to TUDOG.						
Alt Set: INCHES		Trans level: FL180		Trans alt: 18000'		
1. Radar required. 2. SAFE ALTITUDE WITHIN 100 NM 4900'. 3. Simultaneous approach authorized with Rwy 05. 4. LOC reliable only within 10° either side of centerline. 5. Procedure turn not authorized.						

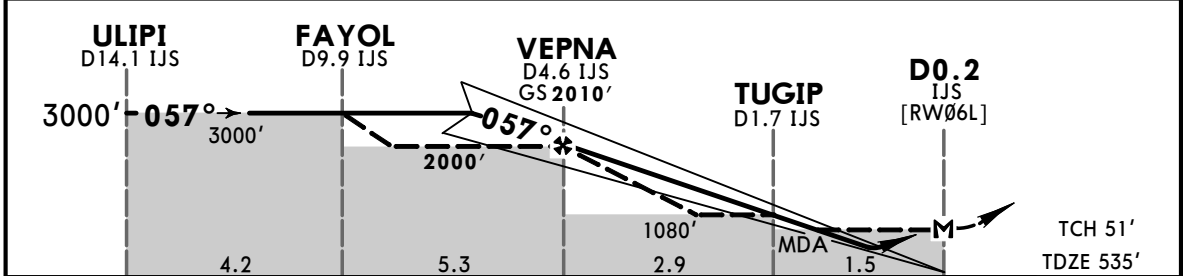
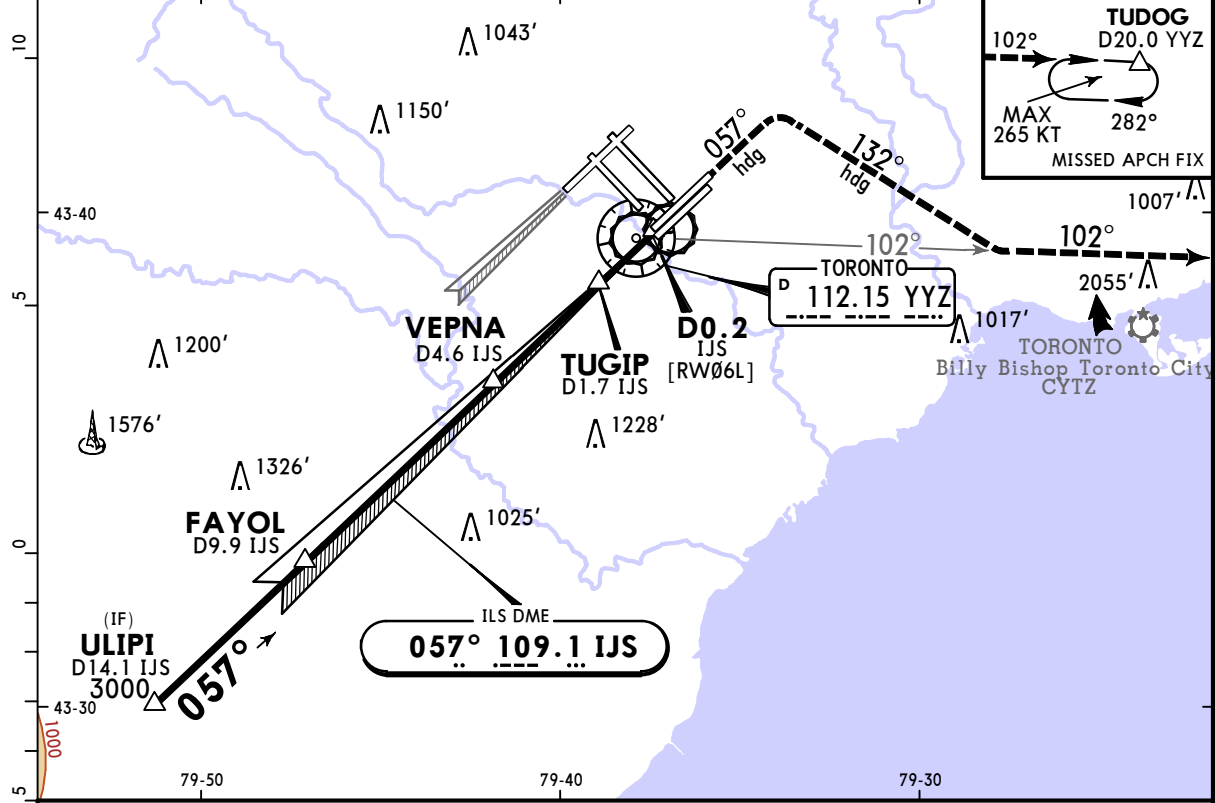

Gnd speed-Kts	70	90	100	120	140	160	ALSIF-II PAPI	1100'	057° hdg	3100'	132° hdg
ILS GS	3.00°	372	478	531	637	743		849	↑	RT	
LOC Descent Angle	3.08°	381	490	545	654	763	872				

State				STRAIGHT-IN LANDING			
ILS DME		LOC (GS out) DME		ILS DME		LOC (GS out) DME	
DA(H) 735' (200')		DA(H) 785' (250')		MDA(H) 960' (425')			
FULL		HIALS out		HIALS out			
A							
B							
C	R26 or V1/2	R50 or V1	R50 or V1	R50 or V1	V1 1/4		
D							

CYYZ/YYZ

JEPPESEN

TORONTO, ONT

LESTER B PEARSON INTL

28 APR 23 **11-2A**

ILS CAT II or III Rwy 06L

D-ATIS 120.825 133.1		LONDON Radio 123.275	TORONTO Arrival 132.8 124.475 125.4			TORONTO Tower 118.35 118.7		Ground 121.9 121.65 119.1	
LOC IJS 109.1	Final Apch Crs 057°	GS VEPNA 2010'(1481')	CAT IIIC NA	CAT IIIB	CAT IIIA Refer to Minimums	CAT II RA 147' DA(H) 630'(101')	Apt Elev 569'	Rwy 529'	<p>MSA YYZ VOR</p>
<p>MISSED APCH: Climb to 1100' heading 057°. Climbing RIGHT turn to 3100' heading 132° to intercept outbound YYZ VOR R-102 to TUDOG.</p> <p>Alt Set: INCHES Trans level: FL180 Trans alt: 18000'</p> <p>1. Radar or RNAV required. 2. SAFE ALTITUDE WITHIN 100 NM 4900'. 3. PRIOR AUTHORIZATION REQUIRED FROM TRANSPORT CANADA. 4. Simultaneous approach authorized with Rwy 05. 5. LOC reliable only within 10° either side of centerline. 6. Procedure turn not authorized.</p>									

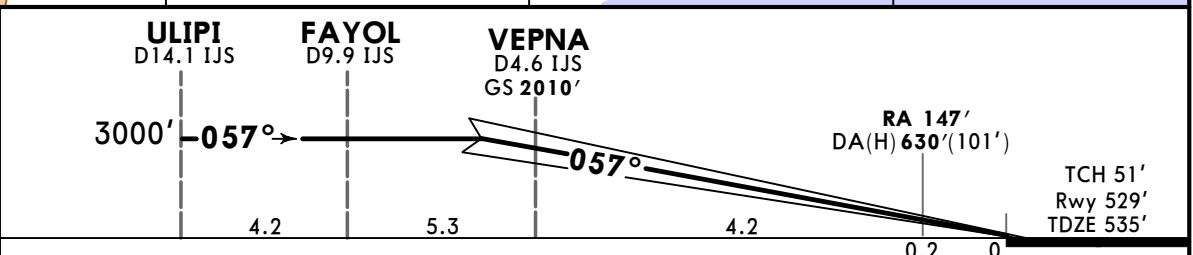
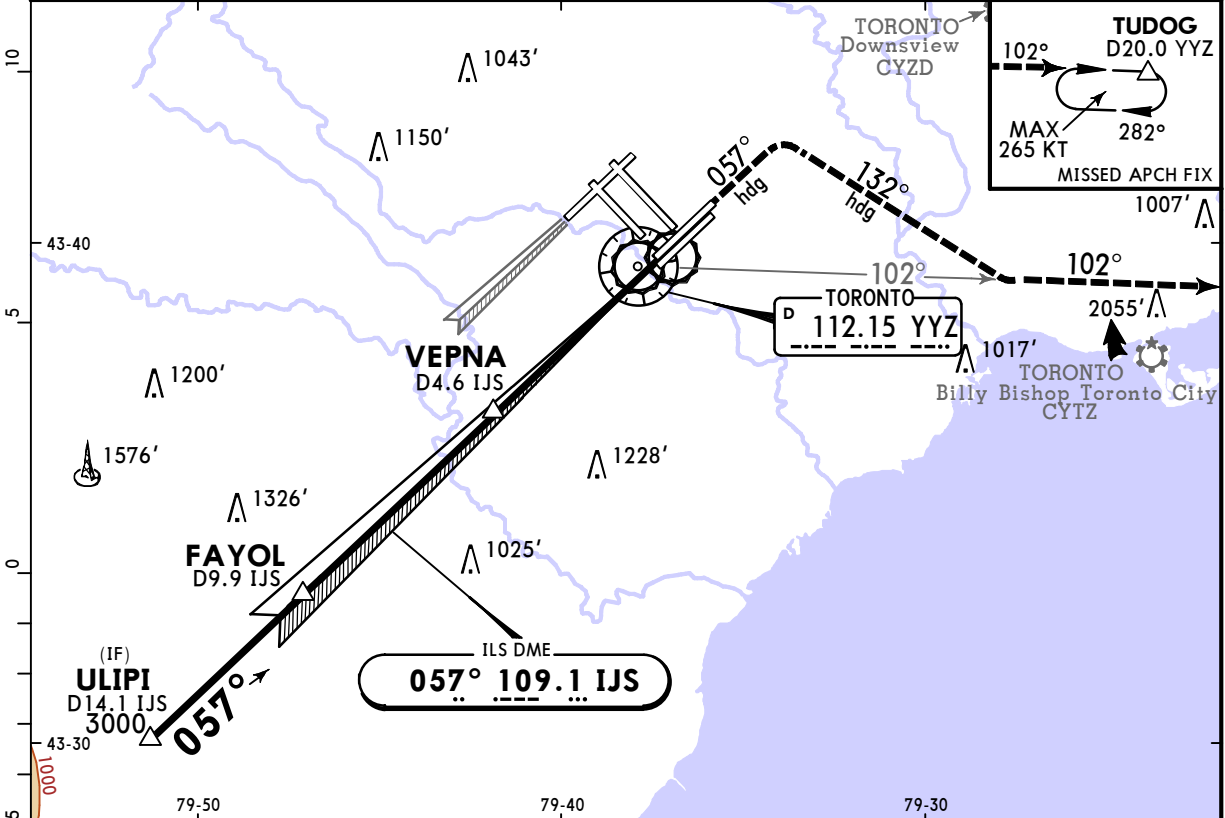

Gnd speed-Kts	70	90	100	120	140	160	ALSF-II PAPI
GS	3.00°	372	478	531	637	743	

State				STRAIGHT-IN LANDING			
CAT IIIC ILS	CAT IIIB ILS	CAT IIIA ILS	CAT II ILS RA 147' DA(H) 630'(101')	CAT IIIC ILS	CAT IIIB ILS	CAT IIIA ILS	CAT II ILS RA 147' DA(H) 630'(101')
NOT AUTHORIZED	NOT AUTHORIZED	R6	R12	NOT AUTHORIZED	NOT AUTHORIZED	R6	R12

CYYZ/YYZ

LESTER B PEARSON INTL

JEPPESSEN
28 APR 23 **(11-3)**

TORONTO, ONT
ILS Rwy 06R

D-ATIS	LONDON Radio	TORONTO Arrival			TORONTO Tower		Ground		
120.825 133.1	123.275	132.8	124.475	125.4	118.35	118.7	121.9	121.65 119.1	
LOC ICV 111.95	Final Apch Crs 057°	GS SAVOS 2010' (1472')	ILS DME DA(H) Refer to Minimums		Apt Elev 569' TDZE 538'		<p>MSA YYZ VOR</p>		
MISSED APCH: Climb to 1100' heading 057°. Climbing RIGHT turn to 3100' heading 132°. Then intercept outbound YYZ VOR R-102 to TUDOG.									
Alt Set: INCHES		Trans level: FL180			Trans alt: 18000'				
1. Radar required. 2. SAFE ALTITUDE WITHIN 100 NM 4900'. 3. Simultaneous approach authorized with Rwy 05. 4. Common ILS DME frequencies Rwy 06R & 24L. Verify ident are for this approach. 5. LOC reliable only within 10° either side of centerline. 6. Procedure turn not authorized.									

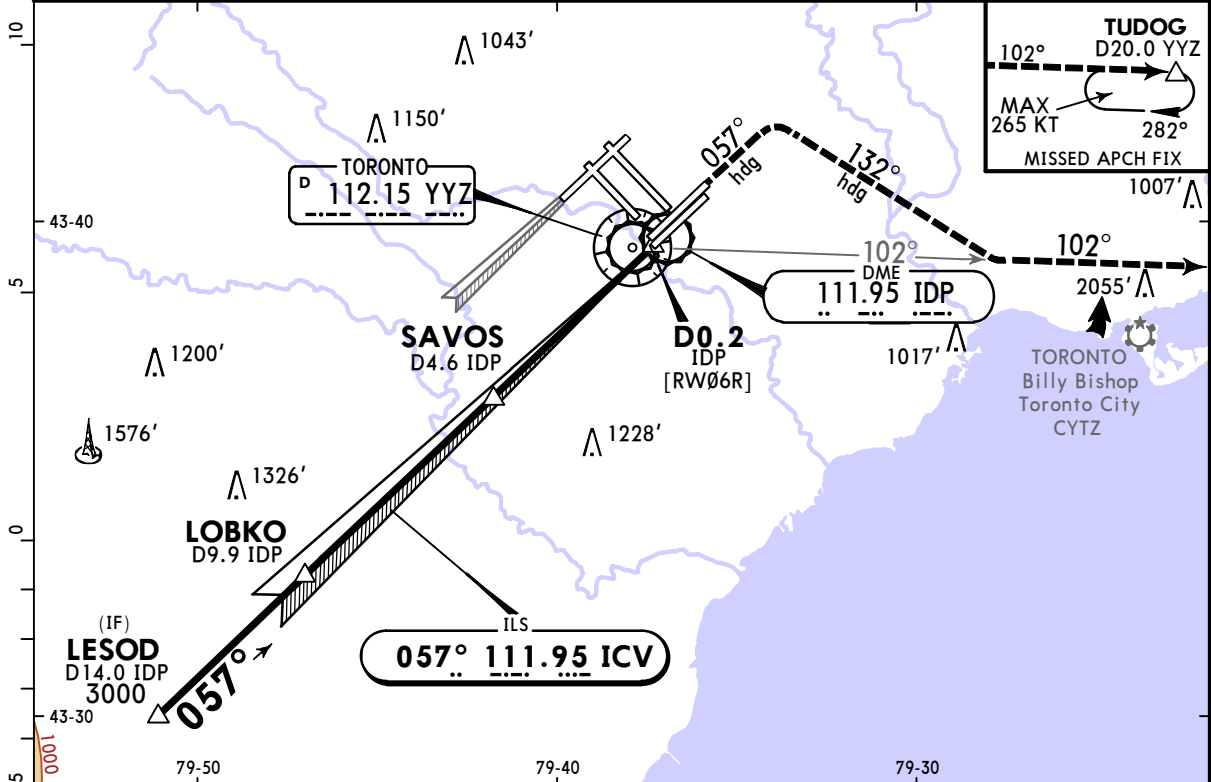

NM to IDP DME	14.0	13.0	12.0	11.0	10.0	9.0	7.8	7.0	6.0	5.0	4.0	3.0	1.8
VDA ALTITUDE	4980'	4660'	4340'	4020'	3700'	3390'	3000'	2750'	2430'	2110'	1790'	1480'	1080'

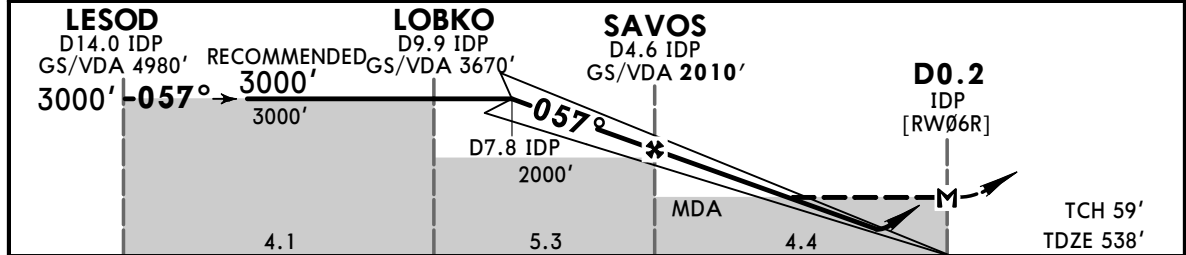

Gnd speed-Kts	70	90	100	120	140	160	SSALR	1100'	057° hdg	3100'	132° hdg
GS/VDA	3.00°	372	478	531	637	849					
MAP at D0.2 IDP							PAPI				

A	State		STRAIGHT-IN LANDING			
	ILS DME		LOC (GS out) DME			
B	DA(H) 738' (200')		DA(H) 788' (250')		MDA(H) 1080' (542')	
C	FULL		HIALS out		HIALS out	
D	R26 or V1/2		R50 or V1		V1 1/4	
					V1 3/4	

CHANGES: Airport name, new AOM concept.

CYYZ/YYZ
LESTER B PEARSON INTL

JEPPESSEN
28 APR 23 **(11-4)**

TORONTO, ONT
ILS Rwy 15L

D-ATIS	LONDON Radio	TORONTO Arrival			TORONTO Tower		Ground		
120.825 133.1	123.275	132.8	124.475	125.4	118.35	118.7	121.9	121.65	119.1
LOC IRW 110.5	Final Apch Crs 147°	GS WOHIL 1820' (1263')	ILS DME DA(H) Refer to Minimums	Apt Elev 569' TDZE 557'					
MISSED APCH: Climb to 1100' heading 147°. Then climbing LEFT turn to 3100' to intercept outbound YYZ VOR R-102 to TUDOG.									
Alt Set: INCHES			Trans level: FL180			Trans alt: 18000'			
1. Radar required. 2. SAFE ALTITUDE WITHIN 100 NM 4900'. 3. Simultaneous approach authorized with Rwy 15R. 4. LOC reliable only within 10° either side of centerline. 5. Low TCH. Aircraft with eye to wheel height at or greater than 22' need to exercise caution. 6. Procedure turn not authorized.									

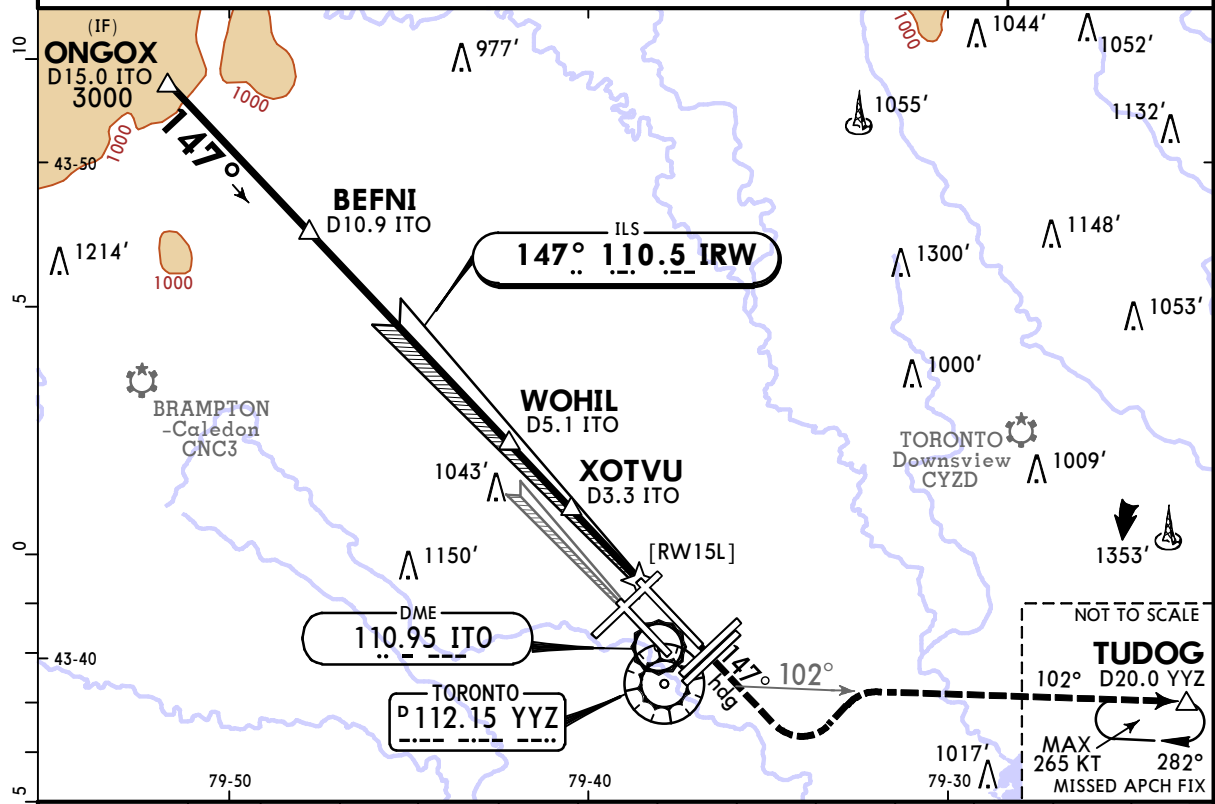

NM to ITO	DME	15.0	14.0	13.0	12.0	11.0	10.0	8.8	8.0	7.0	6.0	5.0	4.0	2.5
VDA ALTITUDE		4990'	4660'	4340'	4020'	3700'	3380'	3000'	2750'	2430'	2110'	1790'	1470'	1000'

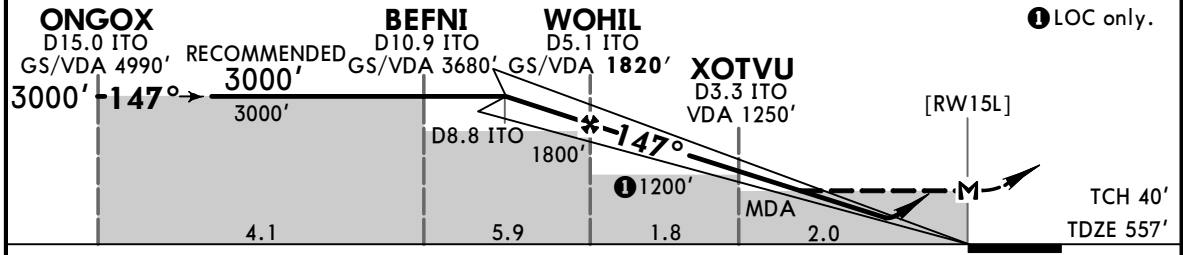

Gnd speed-Kts	70	90	100	120	140	160	SSALR PAPI	1100'	147° hdg	3100'	YYZ 112.15 R-102
GS/VDA	3.00°	372	478	531	637	849		↑		LT	
WOHIL to MAP	3.8	3:15	2:32	2:17	1:54	1:38	1:26				

State				STRAIGHT-IN LANDING			
ILS DME		LOC (GS out) DME		ILS DME		LOC (GS out) DME	
DA(H) 757' (200')		DA(H) 807' (250')		MDA(H) 1000' (443')		MDA(H) 1000' (443')	
FULL		HIALS out		FULL		HIALS out	
A							
B							
C	R26 or V1/2	R50 or V1		R50 or V1		V1 1/2	
D							

CYYZ/YYZ
LESTER B PEARSON INTL

JEPPESSEN
28 APR 23 (11-5)

TORONTO, ONT
ILS Rwy 15R

D-ATIS	LONDON Radio	TORONTO Arrival			TORONTO Tower		Ground		
120.825 133.1	123.275	132.8	124.475	125.4	118.35	118.7	121.9	121.65	119.1
LOC ILP 110.95	Final Apch Crs 147°	GS HOFFS 2010' (1458')	ILS DME DA(H) Refer to Minimums		Apt Elev 569' TDZE 552'				
MISSED APCH: Climb to 1100' heading 147°. Then climbing RIGHT turn to 3000' to intercept outbound YYZ VOR R-189 to PETVO.									
Alt Set: INCHES			Trans level: FL180			Trans alt: 18000'			
1. Radar required. 2. SAFE ALTITUDE WITHIN 100 NM 4900'. 3. Simultaneous approach authorized with Rwy 15L. 4. Common ILS DME frequencies Rws 15R and 33L. Verify identfs are for this approach. 5. LOC reliable only within 10° either side of centerline. 6. Procedure turn not authorized.									

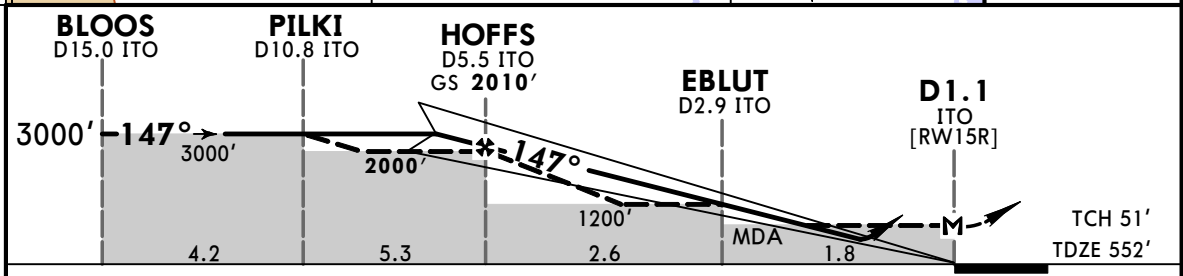
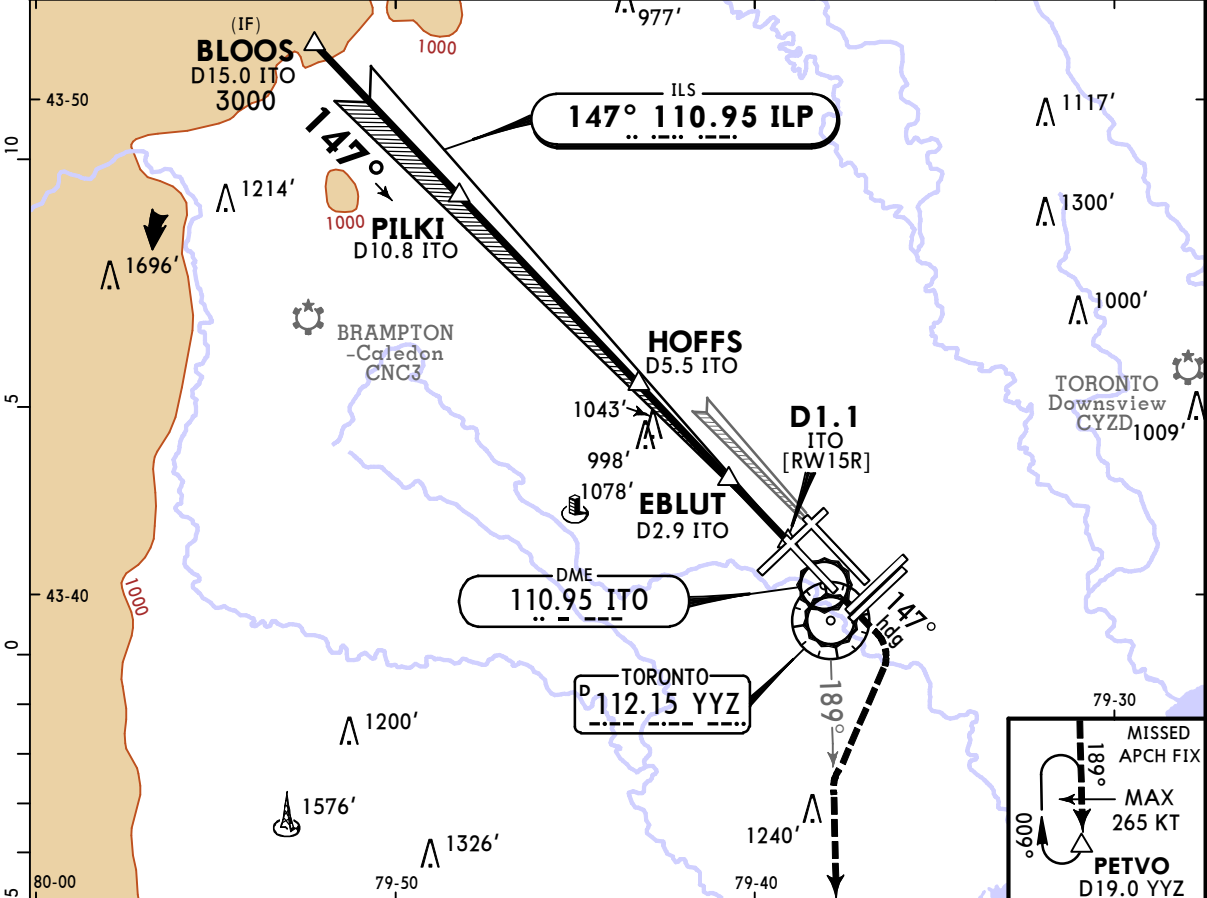

Gnd speed-Kts	70	90	100	120	140	160	SSALR PAPI	1100'	147° hdg	3000'	YYZ 112.15 R-189
ILS GS	3.00°	372	478	531	637	743		849	↑	↻	↻
LOC Descent Angle	3.20°	396	510	566	679	793		906			
MAP at D1.1 ITO											

State				STRAIGHT-IN LANDING				
ILS DME		LOC (GS out) DME		ILS DME		LOC (GS out) DME		
DA(H) 752' (200')		DA(H) 802' (250')		MDA(H) 980' (428')		MDA(H) 980' (428')		
FULL		HIALS out		HIALS out		HIALS out		
A								
B								
C	R26 or V1/2		R50 or V1		R50 or V1		V1 1/4	
D								

CHANGES: Airport name, new AOM concept.

CYYZ/YYZ

LESTER B PEARSON INTL

JEPPESSEN
28 APR 23 **(11-6)**

TORONTO, ONT
ILS Rwy 23

D-ATIS	LONDON Radio	TORONTO Arrival			TORONTO Tower		Ground		
120.825 133.1	123.275	132.8	124.475	125.4	118.35	118.7	121.9	121.65	119.1

BRIEFING STRIP™

LOC YZ 111.5	Final Apch Crs 237°	GS OMTOK 1970' (1413')	ILS DME DA(H) 808' (250')	Apt Elev 569' Rwy 557'
---------------------------	----------------------------------	-------------------------------------	--	---------------------------

MISSED APCH: Climb to 1100' heading 237°. Then climbing RIGHT turn to 3000' to intercept outbound YYZ VOR R-287 to IKDOT.

Alt Set: INCHES Trans level: FL180 Trans alt: 18000'

1. Radar required. 2. SAFE ALTITUDE WITHIN 100 NM 4900'. 3. Simultaneous approach authorized with Rwy 24R or 24L. 4. LOC reliable only within 10° either side of centerline. 5. Procedure turn not authorized.

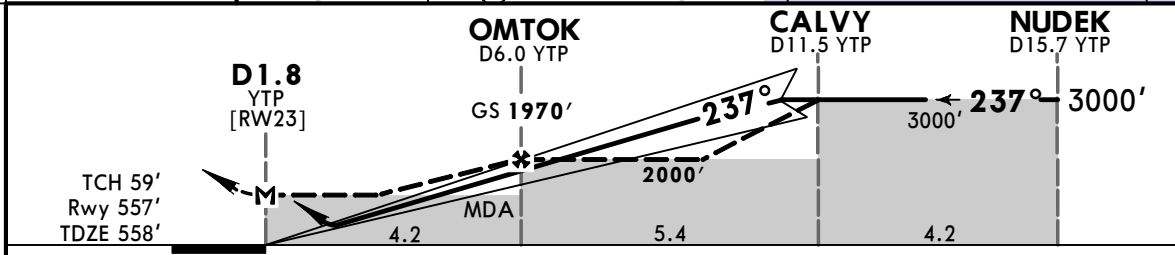
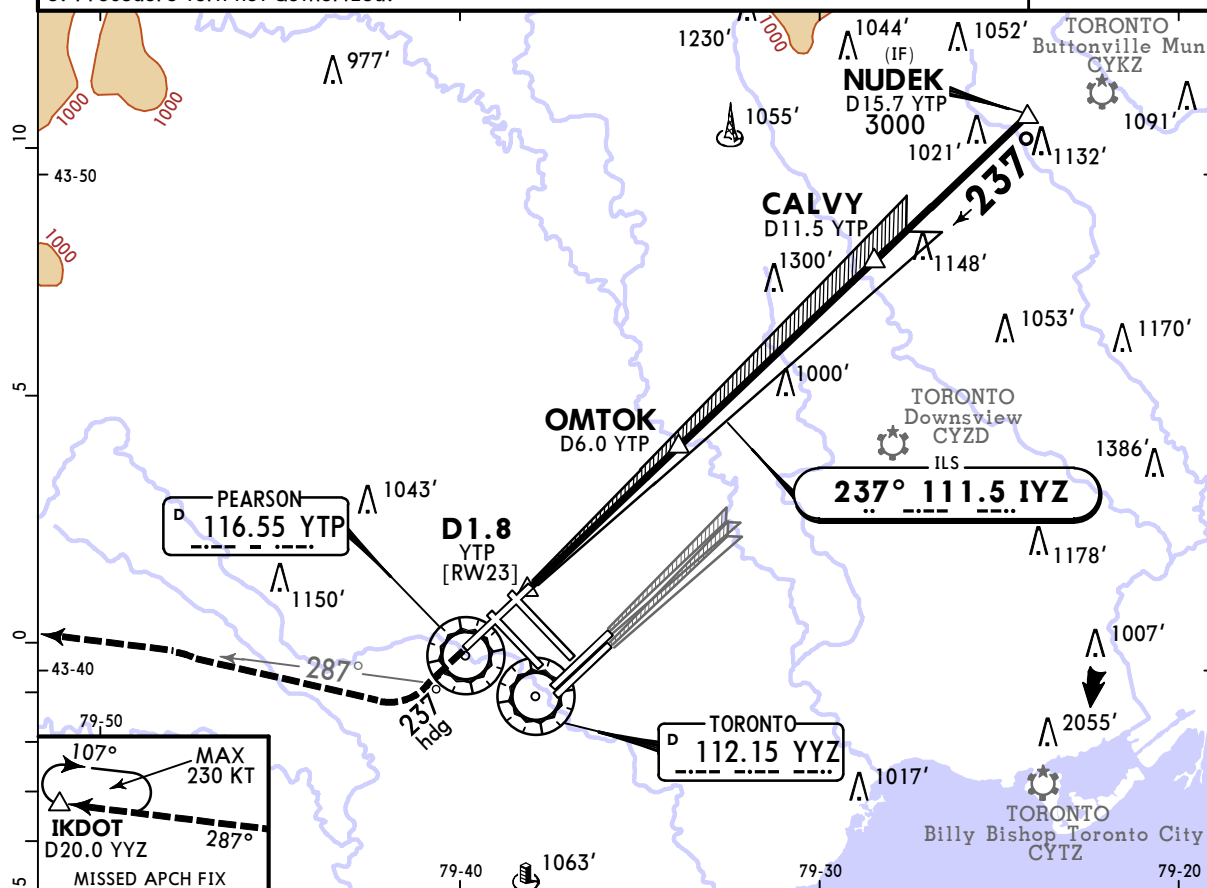
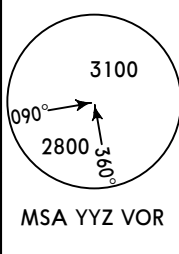

Gnd speed-Kts	70	90	100	120	140	160	SSALR	1100'	237°	3000'	YYZ
ILS GS	3.00°	372	478	531	637	743	PAPI	↑	hdg	RT	112.15
LOC Descent Angle	3.10°	384	494	548	658	878					R-287
MAP at D1.8 YTP											

State												
ILS DME DA(H) 808' (250')						LOC (GS out) DME MDA(H) 980' (423')						
FULL			HIALS out			FULL			HIALS out			
A	R50 or V1					R50 or V1					V1 1/4	
B												
C												
D												

CYYZ/YYZ LESTER B PEARSON INTL

JEPESEN
28 APR 23 (11-7)

TORONTO, ONT
ILS Rwy 24L

D-ATIS 120.825 133.1	LONDON Radio 123.275	TORONTO Arrival 132.8 124.475 125.4			TORONTO Tower 118.35 118.7	Ground 121.9 121.65 119.1
LOC IDP 111.95	Final Apch Crs 237°	GS KIREX 1970' (1423')	ILS DME DA(H) Refer to Minimums	Apt Elev 569' TDZE 547'		<p>MSA YYZ VOR</p>
MISSED APCH: Climb heading 237° to D1.5 IDP. Climbing LEFT turn to 3000' heading 159° to intercept outbound YYZ VOR R-189 to PETVO.						
Alt Set: INCHES Trans level: FL180 Trans alt: 18000' 1. Radar or RNAV required. 2. SAFE ALTITUDE WITHIN 100 NM 4900'. 3. Simultaneous approach authorized with Rwy 23. 4. Common ILS/DME frequencies Rwy 06R and 24L. Verify idents are for this approach. 5. LOC reliable only within 10° either side of centerline. 6. Procedure turn not authorized.						

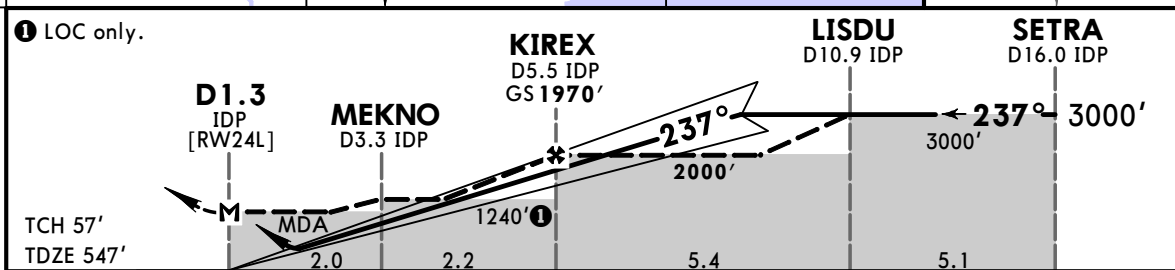
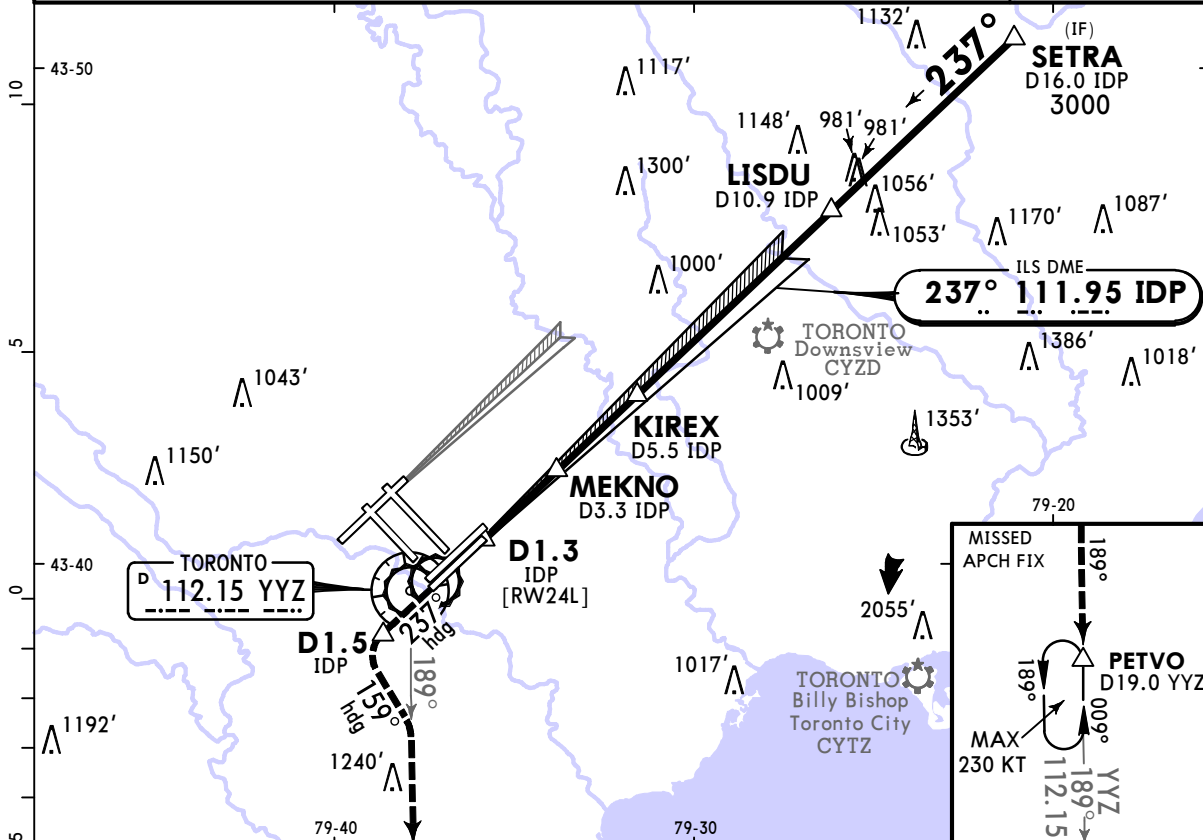

Gnd speed-Kts	70	90	100	120	140	160	SSALR PAPI	↑	237° hdg	D1.5 IDP	3000' LT	159° hdg
ILS GS	3.00°	372	478	531	637	743						
LOC Descent Angle	3.10°	384	494	548	658	768	878	MAP at D1.3 IDP				

State				STRAIGHT-IN LANDING				
ILS DME		LOC (GS out) DME		ILS DME		LOC (GS out) DME		
DA(H) 747' (200')		DA(H) 797' (250')		MDA(H) 980' (433')		MDA(H) 980' (433')		
FULL		HIALS out		HIALS out		HIALS out		
A								
B								
C	R26 or V1/2		R50 or V1		R50 or V1		V1 1/4	
D								

CYYZ/YYZ LESTER B PEARSON INTL



TORONTO, ONT ILS Rwy 24R

28 APR 23 (11-8)

D-ATIS 120.825 133.1	LONDON Radio 123.275	TORONTO Arrival 132.8 124.475 125.4			TORONTO Tower 118.35 118.7		Ground 121.9 121.65 119.1	
-------------------------	-------------------------	--	--	--	-------------------------------	--	------------------------------	--

BRIEFING STRIP™

LOC INV 109.3	Final Apch Crs 237°	GS NOAHA 1970' (1424')	ILS DME DA(H) 796' (250')	Apt Elev 569' TDZE 546'
-------------------------	-------------------------------	----------------------------------	-------------------------------------	----------------------------

MISSED APCH: Climb heading 237° to D1.5 INV. Climbing LEFT turn to 3000' heading 189° to intercept outbound YYZ VOR R-189 to PETVO.

Alt Set: INCHES Trans level: FL180 Trans alt: 18000'
 1. Radar or RNAV required. 2. CAUTION: Twy Charlie (600' right of centerline) similar in appearance to Rwy. 3. SAFE ALTITUDE WITHIN 100 NM 4900'. 4. Simultaneous approach authorized with Rwy 23. 5. LOC reliable only within 10° either side of centerline. 6. Procedure turn not authorized.

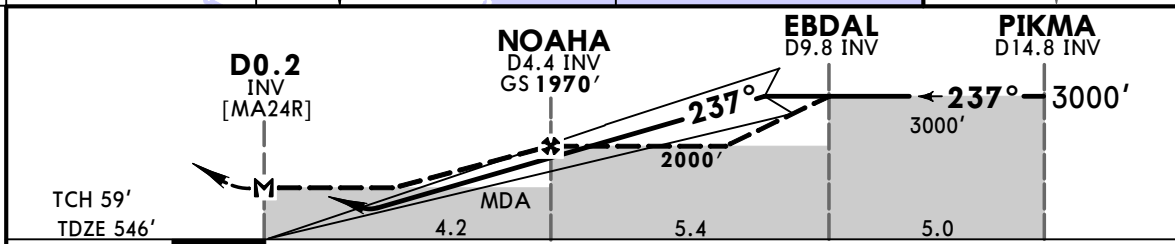
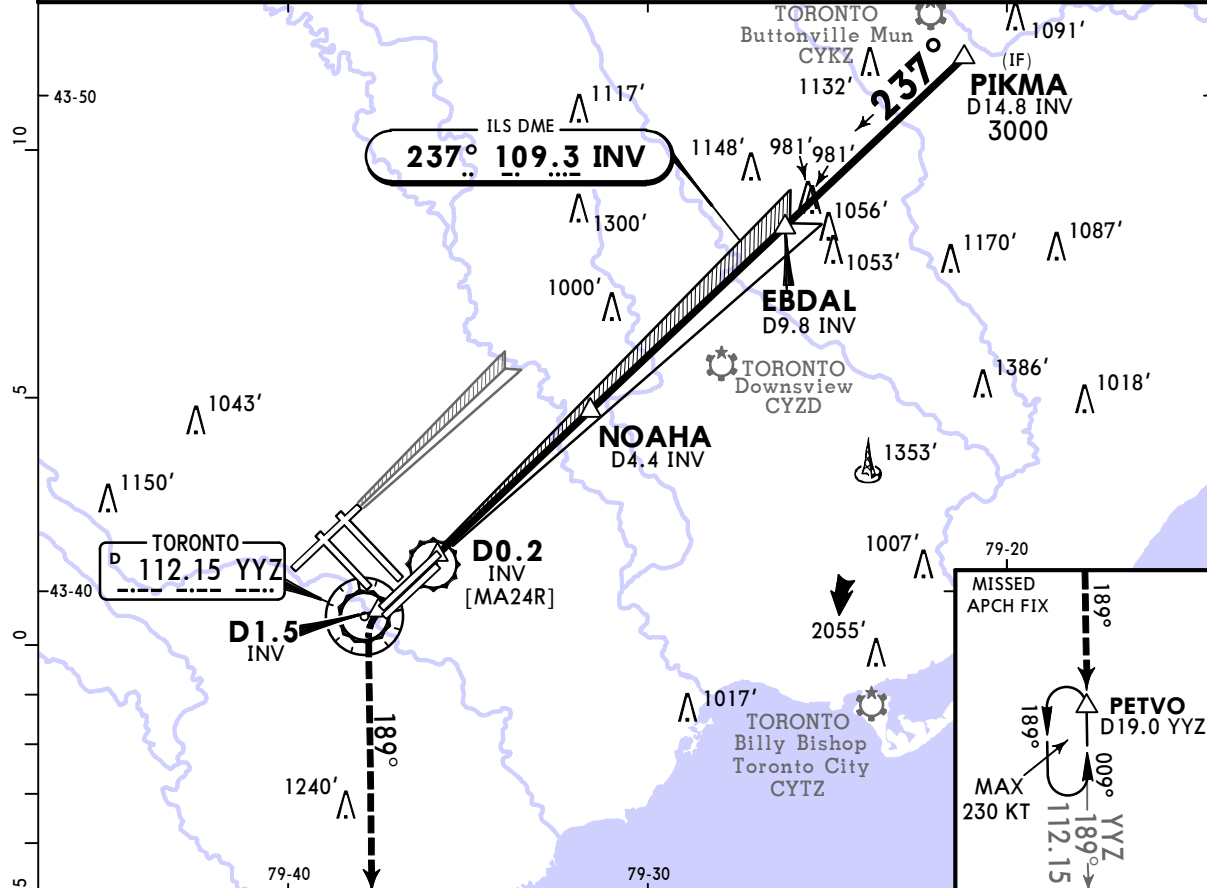
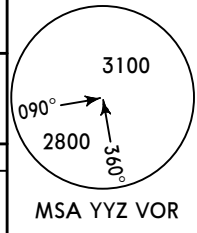

Gnd speed-Kts	70	90	100	120	140	160	SSALS	↑	237° hdg	D1.5 INV	3000' LT	189° hdg	
ILS GS	3.00°	372	478	531	637	743	849						REIL
LOC Descent Angle	3.10°	384	494	548	658	768	878						PAPI

State		STRAIGHT-IN LANDING	
ILS DME DA(H) 796' (250')		LOC (GS out) DME MDA(H) 980' (434')	
ALS out		ALS out	
A	R50 or V1	V1 1/4	
B			
C			
D			

CYYZ/YYZ
LESTER B PEARSON INTL



TORONTO, ONT
ILS Rwy 33L

D-ATIS 120.825 133.1	LONDON Radio 123.275	TORONTO Arrival 132.8 124.475 125.4			TORONTO Tower 118.35 118.7	Ground 121.9 121.65 119.1
LOC ITO 110.95	Final Apch Crs 327°	GS APMAM 2020' (1472')	ILS DME DA(H) 838' (290')	Apt Elev 569' TDZE 548'		
MISSED APCH: Climb to 1100' heading 327°. Climbing LEFT turn to 3000' heading 257°. Then intercept outbound YYZ VOR R-287 to IKDOT.						
Alt Set: INCHES		Trans level: FL180		Tran alt: 18000'		MSA YYZ VOR
1. Radar required. 2. SAFE ALTITUDE WITHIN 100 NM 4900'. 3. Simultaneous approach authorized with Rwy 33R. 4. Common ILS DME frequencies Rwy 15R and 33L. Verify ident. 5. LOC reliable only within 10° either side of centerline. 6. Procedure turn not authorized.						

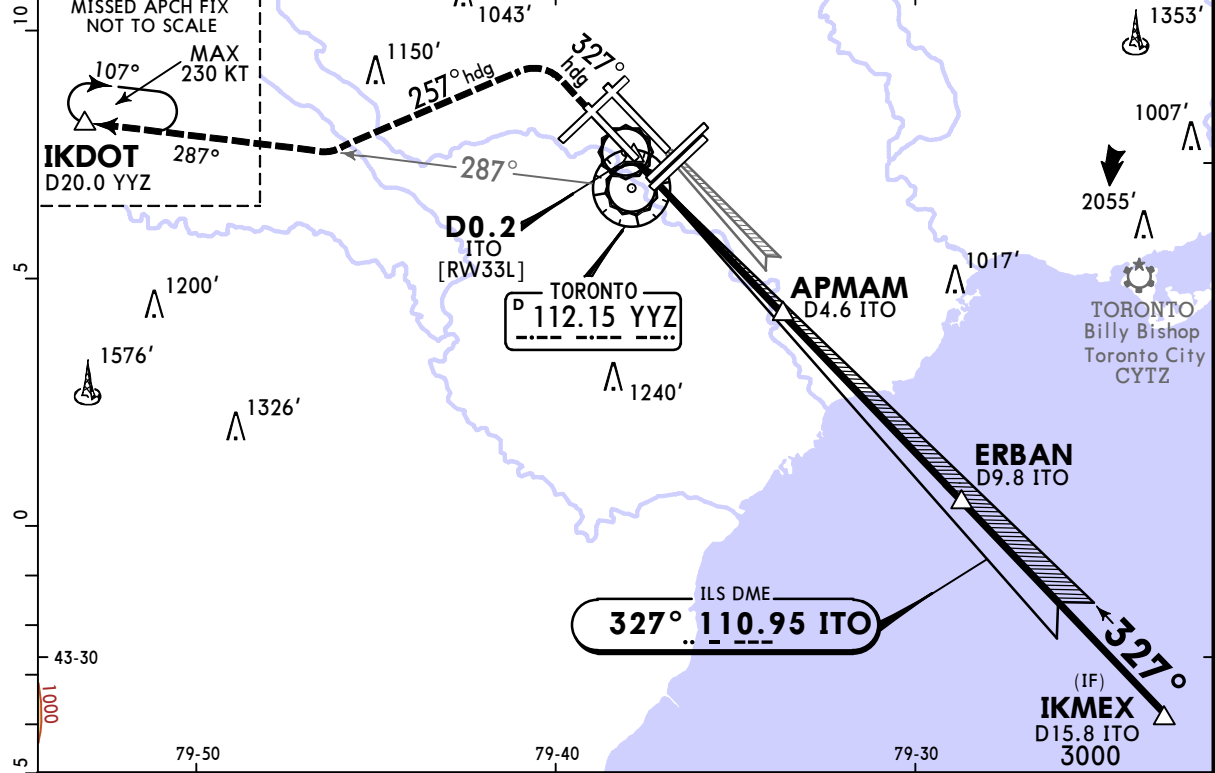

NM to ITO DME	1.2	2.0	3.0	4.0	5.0	6.0	7.0	7.7	9.0	10.0	11.0	13.0	15.8
VDA ALTITUDE	920'	1190'	1500'	1820'	2140'	2460'	2780'	3000'	3410'	3730'	4050'	4690'	5580'

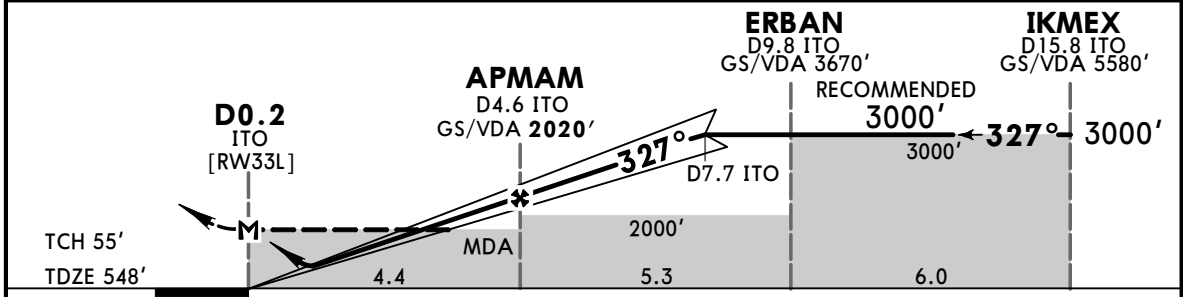

Gnd speed-Kts	70	90	100	120	140	160	SSALR	1100'	327° hdg	3000'	257° hdg
GS/VDA	3.00°	372	478	531	637	849					
MAP at D0.2 ITO							PAPI				

State				STRAIGHT-IN LANDING			
ILS DME		LOC (GS out) DME		ILS DME		LOC (GS out) DME	
DA(H) 838' (290')		MDA(H) 920' (372')		DA(H) 838' (290')		MDA(H) 920' (372')	
FULL		HIALS out		FULL		HIALS out	
A	R50 or V1			R50 or V1			V1 1/4
B							
C							
D							

CHANGES: Airport name, new AOM concept.

CYYZ/YYZ
LESTER B PEARSON INTL

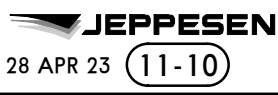

TORONTO, ONT
ILS Rwy 33R

D-ATIS		LONDON Radio	TORONTO Arrival			TORONTO Tower		Ground		
120.825 133.1		123.275	132.8	124.475	125.4	118.35	118.7	121.9	121.65	119.1
LOC ILE	Final Apch Crs	GS LETAG	ILS DME DA(H)		Apt Elev 569'					
110.3	327°	2020' (1456')	Refer to Minimums		TDZE 564'					
MISSED APCH: Climb to 1100' heading 327°. Climbing RIGHT turn to 3000' heading 043°. Then intercept outbound YYZ VOR R-013 to AVTEK.										
Alt Set: INCHES			Trans level: FL180				Trans alt: 18000'			
1. Radar required. 2. SAFE ALTITUDE WITHIN 100 NM 4900'. 3. Simultaneous approach authorized with Rwy 33L. 4. LOC reliable only within 10° either side of centerline. 5. Procedure turn not authorized.										

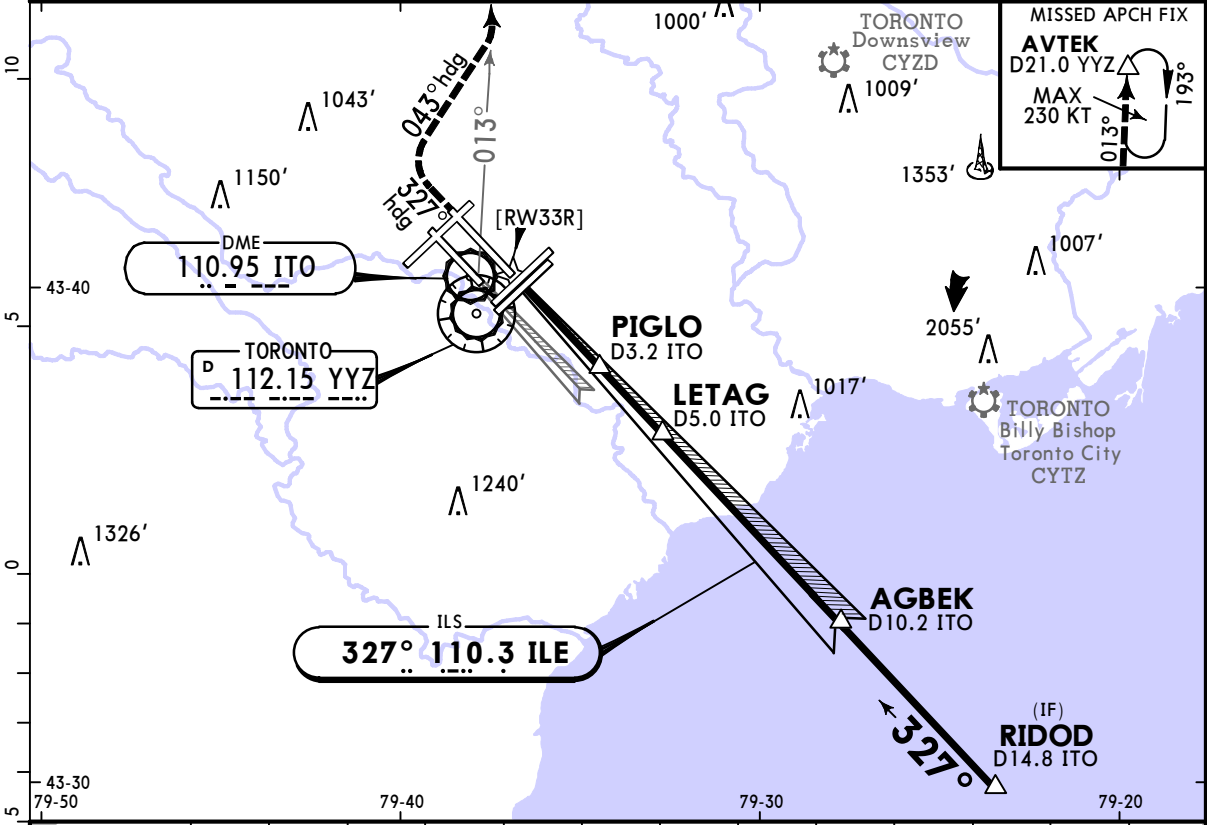

NM to ITO DME	1.7	3.0	4.0	5.0	6.0	7.0	8.1	9.0	10.0	11.0	12.0	13.0	14.8
VDA ALTITUDE	960'	1370'	1690'	2010'	2330'	2650'	3000'	3280'	3600'	3920'	4240'	4560'	5130'

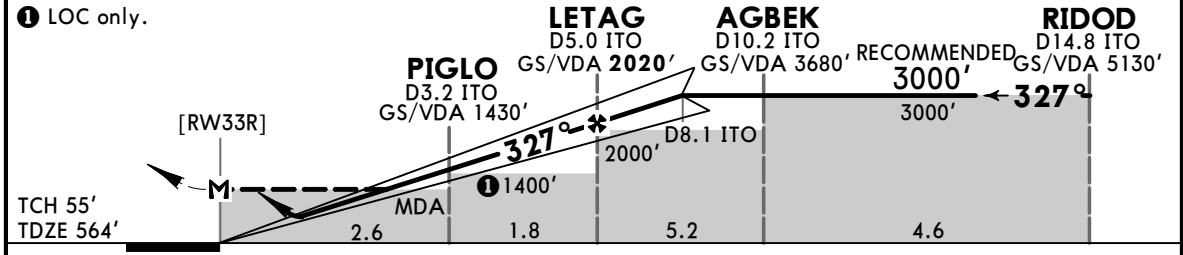

Gnd speed-Kts	70	90	100	120	140	160	SSALR	1100'	327° hdg	3000'	043° hdg
GS/VDA	3.00°	372	478	531	637	849					
LETAG to MAP	4.4	3:46	2:56	2:38	2:12	1:53	PAPI				

State				STRAIGHT-IN LANDING				
ILS DME		LOC (GS out) DME		ILS DME		LOC (GS out) DME		
DA(H) 767' (203')		DA(H) 814' (250')		DA(H) 767' (203')		DA(H) 814' (250')		
FULL		HIALS out		MDA(H) 960' (396')		HIALS out		
A								
B								
C	R26 or V1/2		R50 or V1		R50 or V1		V1 1/4	
D								

CYYZ/YYZ



 28 APR 23 (12-0)

 TORONTO, ONT
 LESTER B PEARSON INTL

Established on RNP AR (EoR) User Instructions ATTENTION ALL USERS OF EoR

EoR is a procedure applied by Toronto Terminal air traffic controllers to aircraft conducting RNP-AR approaches (RNAV Y). EoR safely permits reduced vertical and lateral separation between aircraft, during ATC-monitored simultaneous independent parallel approaches.

Operational Requirements

- EoR will be used during simultaneous parallel runway operations, and ATIS shall indicate when simultaneous parallel runway operations are in effect.
- RNP-AR (RNAV Y) approaches are **ONLY** available to Runway 05 via the BOXUM/DUVOS/IMEBA/VIBLI STARS.
- RNP-AR (RNAV Y) approaches to Runway 23 are **ONLY** available via BOXUM/DUVOS/NUBER/NAKBO STARS.
- When an EoR operation is in use, RNAV Y will be the only advertised approach to Runway 05/23. RNP-AR capable aircraft that are assigned Runway 05/23 are expected to plan and fly the RNAV Y approach.
- Non RNP-AR aircraft assigned Runway 05/23 should anticipate radar vectors to an ILS approach.
- Aircraft that are RNP-AR capable but cannot fly the RNAV Y RNP-AR approach must inform ATC and can expect an ILS or visual approach.
- RNP-AR capable aircraft that are unable to be cleared using the RF transition will be advised by ATC to expect vectors to final. Aircraft should plan radar vectors to the RNAV Y straight-in transition.
- When cleared for an RNAV Y RNP-AR approach, the aircraft is considered "established" on the approach procedure once it is on the defined lateral and vertical path and past the IWP (IF) for the procedure.
- The approach shall be flown using autopilot until the aircraft passes the final approach waypoint (FAF).
- If unable to comply with an ATC clearance or conduct the cleared approach, for any reason, immediately advise the controller. **DO NOT** attempt to self-navigate or manually correct an RNP-AR approach procedure deviation. Immediately advise the controller using the phraseology example below then comply with subsequent ATC instructions:

Pilot: "UNABLE [IWP Transition] transition, REQUEST (proposed course of action)"

Example: **Pilot:** "NAVCAN 123 UNABLE MODOL TRANSITION, REQUEST VECTORS TO FINAL"

Break-out Instructions

When issued break-out instructions, reaction time may be critical. If expeditious compliance is required, an ATC break-out instruction may include the word IMMEDIATELY.

- ATC shall issue any required break-out instruction by assigning a heading and/or altitude instruction:
Example: **ATC:** "NAVCAN 123, turn left immediately heading 330 degrees, climb to 3000"
- Established on RNP AR break-out procedures may be conducted with the autopilot on

CYYZ/YYZ
LESTER B PEARSON INTL

JEPPESSEN
28 APR 23 (12-1)

TORONTO, ONT
RNAV (GNSS) Z Rwy 05

D-ATIS	LONDON Radio	TORONTO Arrival			TORONTO Tower		Ground	
120.825 133.1	123.275	132.8	124.475	125.4	118.35	118.7	121.9	121.65 119.1
WAAS Ch 80629 W-05A	Final Apch Crs 057°	GPA KERPU 2000' (1436')	LPV DA(H) Refer to Minimums	Apt Elev 569'	Rwy 564'			
MISSED APCH: Climb to 1100' heading 057°. Then climbing LEFT turn to 3000' direct to AVTEK.							3100	
Alt Set: INCHES		Trans level: FL180			Trans alt: 18000'			
1. SAFE ALTITUDE WITHIN 100 NM 4900'. 2. Simultaneous approach authorized with Rwy 06L or 06R. 3. LNAV procedure not authorized during simultaneous operations. 4. For uncompensated Baro-VNAV systems, LNAV/VNAV not authorized below -19°C (-2°F) and above 54°C (129°F).								
MSA RW05								

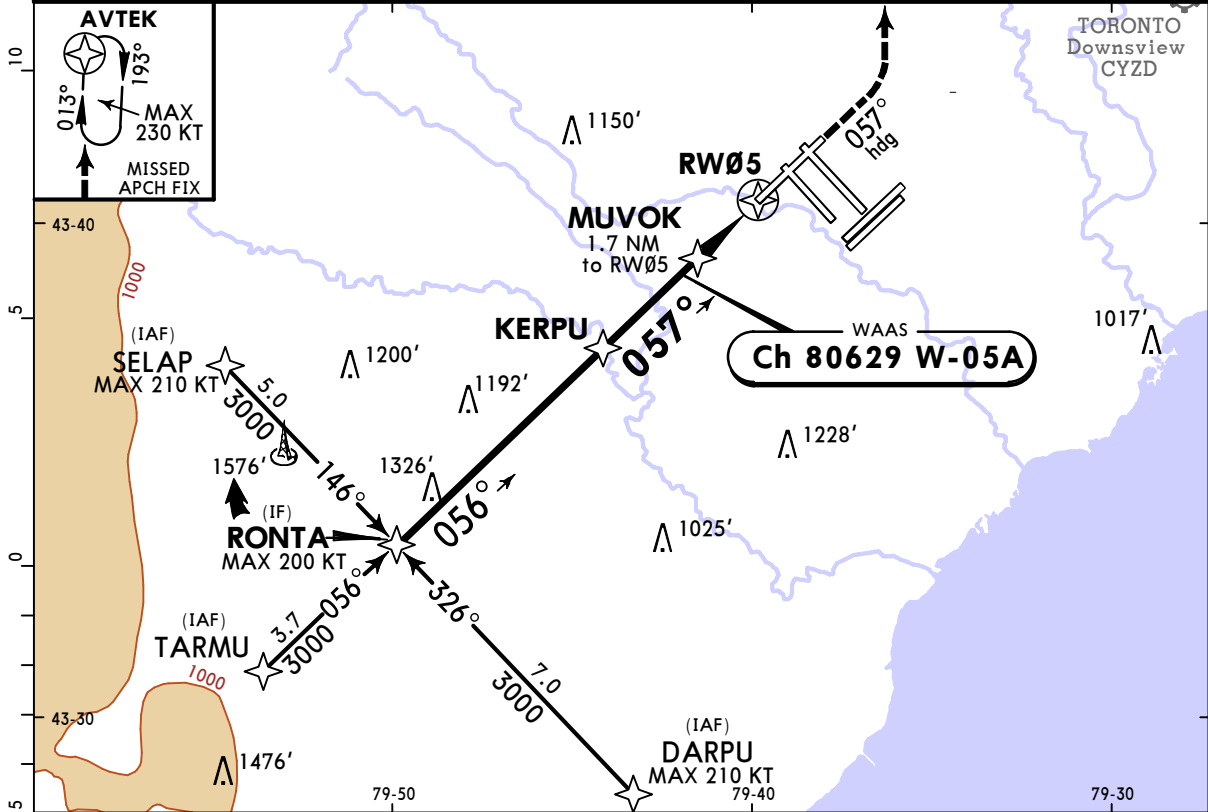

NM to RW05	10.1	9.0	8.0	7.5	6.0	5.0	4.0	3.0	2.0	1.3
VDA ALTITUDE	3840'	3480'	3170'	3000'	2530'	2210'	1890'	1570'	1260'	1040'

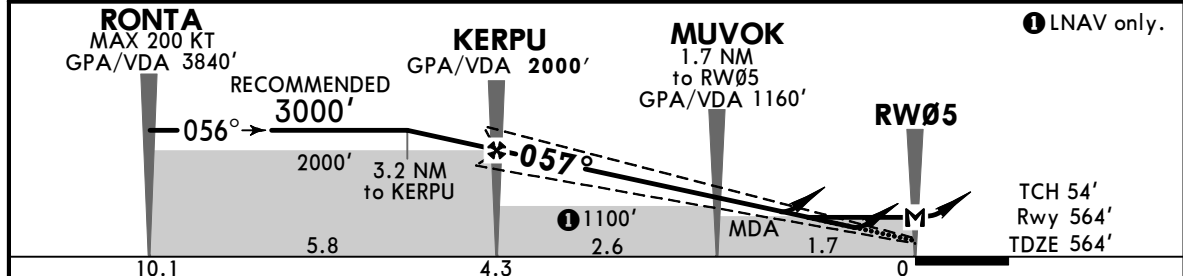

Gnd speed-Kts	70	90	100	120	140	160	ALSF-II PAPI	1100'	057° hdg
GPA/VDA	3.00°	372	478	531	637	743			
MAP at RW05									

State	STRAIGHT-IN LANDING				
	LPV	LNAV/VNAV		LNAV	
	DA(H) 764' (201')	DA(H) 813' (250')	DA(H) 1054' (491')		MDA(H) 1040' (477')
	HIALS out		HIALS out		HIALS out
A					
B					
C	R26 or V1/2	R50 or V1	V1 1/4	V1 1/2	R50 or V1
D					

CYYZ/YYZ LESTER B PEARSON INTL

JEPPESSEN
28 APR 23 (12-2)

TORONTO, ONT RNAV (GNSS) X Rwy 05

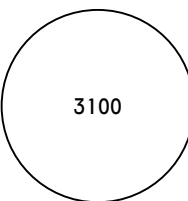
D-ATIS	LONDON Radio	TORONTO Arrival			TORONTO Tower		Ground		
120.825 133.1	123.275	132.8	124.475	125.4	118.35	118.7	121.9	121.65	119.1
WAAS Ch 80717 W-05B	Final Apch Crs 057°	GPA KERPU 2000' (1436')	LPV DA(H) Refer to Minimums	Apt Elev 569' Rwy 564'					
MISSED APCH: Climb to 1100' heading 057°. Then climbing LEFT turn to 3000' direct to AVTEK.									
Alt Set: INCHES Trans level: FL180 Trans alt: 18000'									
1. SAFE ALTITUDE WITHIN 100 NM 4900'. 2. Simultaneous approach authorized with Rwy 06L or 06R. 3. LNAV procedure not authorized during simultaneous operations. 4. For uncompensated Baro-VNAV systems, LNAV/VNAV not authorized below -19°C (-2°F) and above 54°C (129°F).									
MSA RW05									

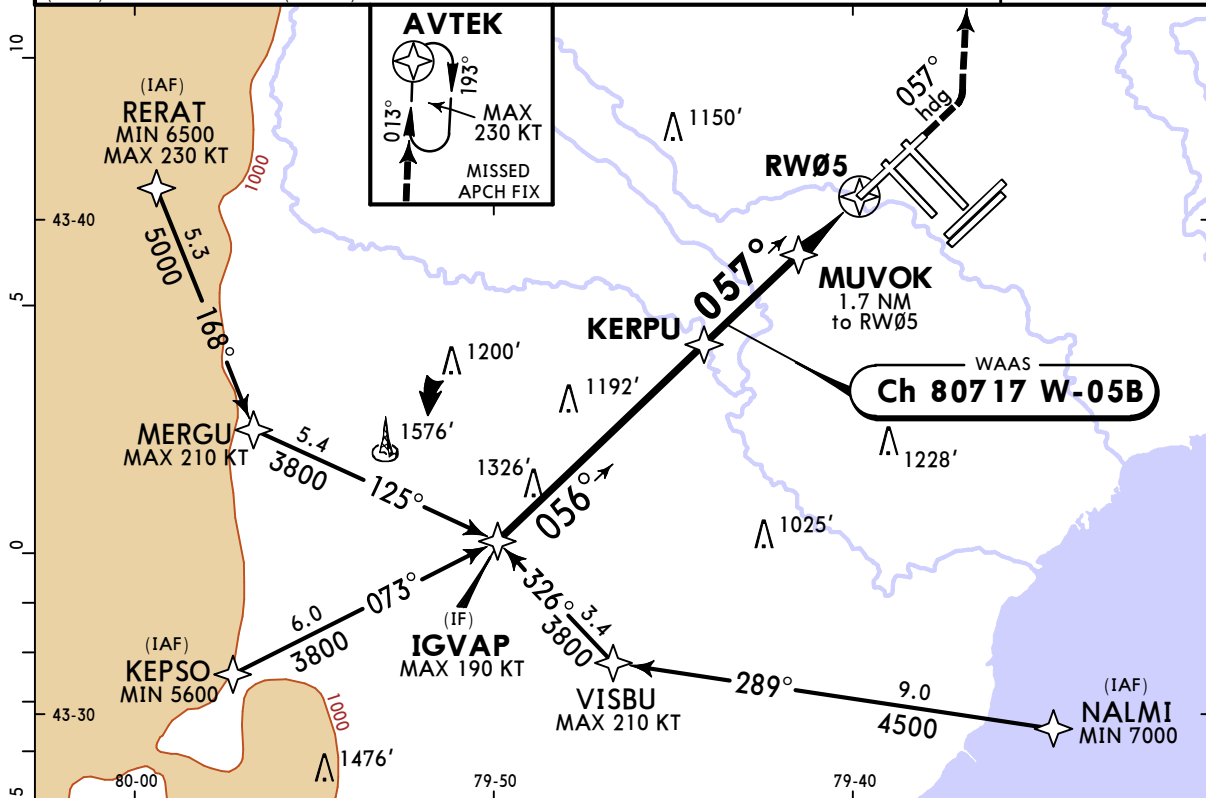

NM to RW05	10.1	10.0	9.0	8.0	7.0	6.0	5.0	4.0	3.0	2.0	1.3
VDA ALTITUDE	3840'	3800'	3480'	3170'	2850'	2530'	2210'	1890'	1570'	1260'	1040'

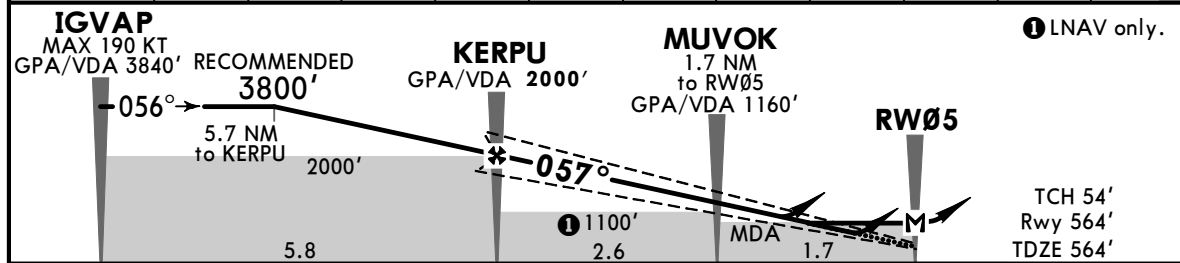

Gnd speed-Kts	70	90	100	120	140	160	ALSIF-II	1100'	057° hdg
GPA/VDA	3.00°	372	478	531	637	849			
MAP at RW05								PAPI	

State	STRAIGHT-IN LANDING				
	LPV		LNAV/VNAV		LNAV
	DA(H) 764' (201')	DA(H) 813' (250')	DA(H) 1054' (491')	MDA(H) 1040' (477')	
	HIALS out		HIALS out		HIALS out
A					
B					
C	R26 or V1/2	R50 or V1	V1 1/4	V1 1/2	R50 or V1
D					

CYYZ/YYZ
LESTER B PEARSON INTL

JEPPESSEN
28 APR 23 (12-3)

TORONTO, ONT
RNAV (GNSS) Z Rwy 06L

D-ATIS	LONDON Radio	TORONTO Arrival			TORONTO Tower	Ground	
120.825 133.1	123.275	132.8	124.475	125.4	118.35 118.7	121.9 121.65 119.1	
WAAS Ch 80630 W-06A	Final Apch Crs 057°	GPA VEPNA 2000' (1471')	LPV DA(H) Refer to Minimums	Apt Elev 569' Rwy 529'			
MISSED APCH: Climb to 1100' heading 057°. Then climbing RIGHT turn to 3100' direct to TUDOG.							
Alt Set: INCHES		Trans level: FL180		Trans alt: 18000'			
1. SAFE ALTITUDE WITHIN 100 NM 4900'. 2. Simultaneous approach authorized with Rwy 05. 3. LNAV procedure not authorized during simultaneous operations. 4. For uncompensated Baro-VNAV systems, LNAV/VNAV not authorized below -19°C (-2°F) and above 54°C (129°F).							

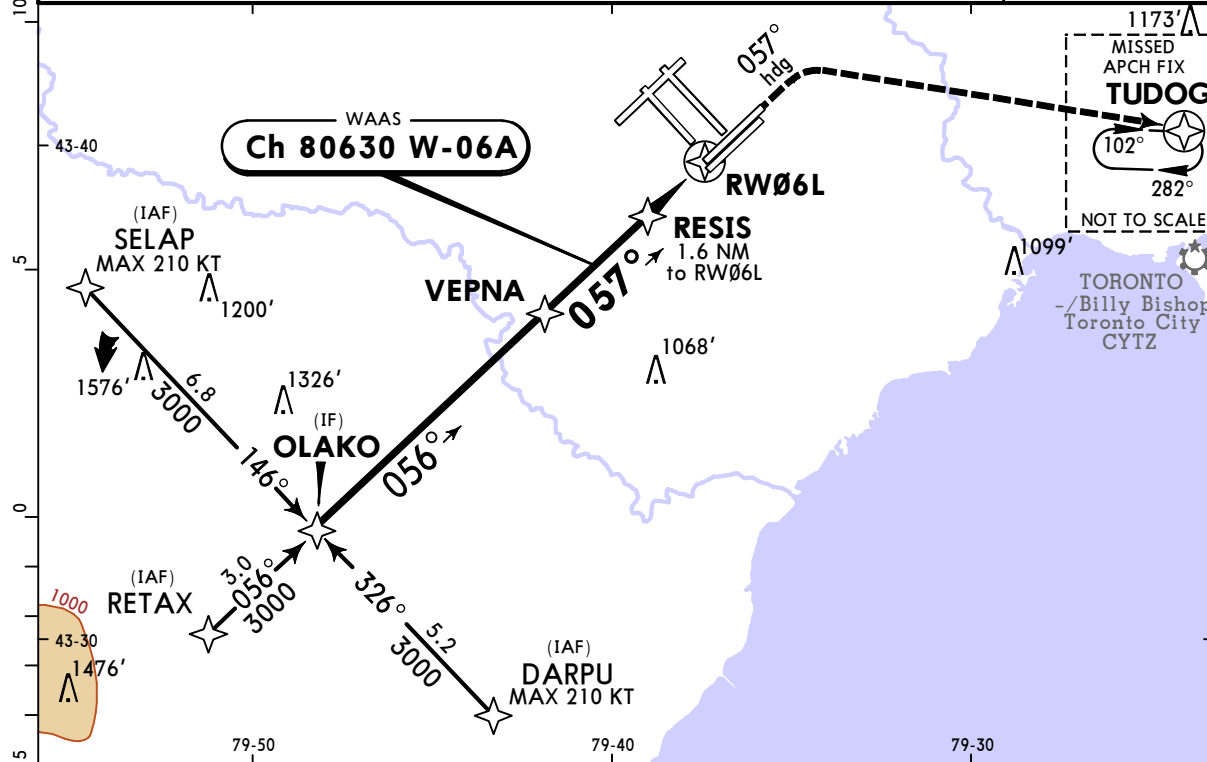

NM to RW06L	10.9	10.0	9.0	7.6	7.0	6.0	5.0	4.0	3.0	2.0	1.2
VDA ALTITUDE	4040'	3760'	3450'	3000'	2810'	2490'	2170'	1850'	1540'	1220'	960'

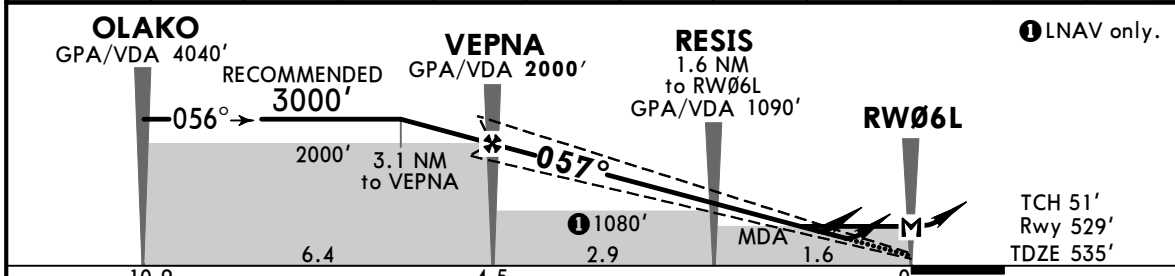

Gnd speed-Kts	70	90	100	120	140	160		1100' ↑	057° hdg
GPA/VDA	3.00°	372	478	531	637	743			
MAP at RW06L									

State	STRAIGHT-IN LANDING				
	LPV	LNAV/VNAV		LNAV	
	DA(H) 730' (201')	DA(H) 779' (250')	DA(H) 877' (348')	MDA(H) 960' (431')	
	HIALS out		HIALS out		HIALS out
A					
B					
C	R26 or V1/2	R50 or V1	R50 or V1	V1 1/4	R50 or V1
D					

CYYZ/YYZ
LESTER B PEARSON INTL

JEPPesen
28 APR 23 (12-4)

TORONTO, ONT
RNAV (GNSS) X Rwy 06L

D-ATIS	LONDON Radio	TORONTO Arrival			TORONTO Tower		Ground		
120.825 133.1	123.275	132.8	124.475	125.4	118.35	118.7	121.9	121.65	119.1
WAAS Ch 80718 W-06E	Final Apch Crs 057°	GPA VEPNA 2000' (1471')	LPV DA(H) Refer to Minimums	Apt Elev 569' Rwy 529'					
MISSED APCH: Climb to 1100' heading 057°. Then climbing RIGHT turn to 3100' direct to TUDOG.									
Alt Set: INCHES Trans level: FL180 Trans alt: 18000'									
1. SAFE ALTITUDE WITHIN 100 NM 4900'. 2. Simultaneous approach authorized with Rwy 05. 3. LNAV procedure not authorized during simultaneous operations. 4. For uncompensated Baro-VNAV systems, LNAV/VNAV not authorized below -19°C (-2°F) and above 54°C (129°F).									

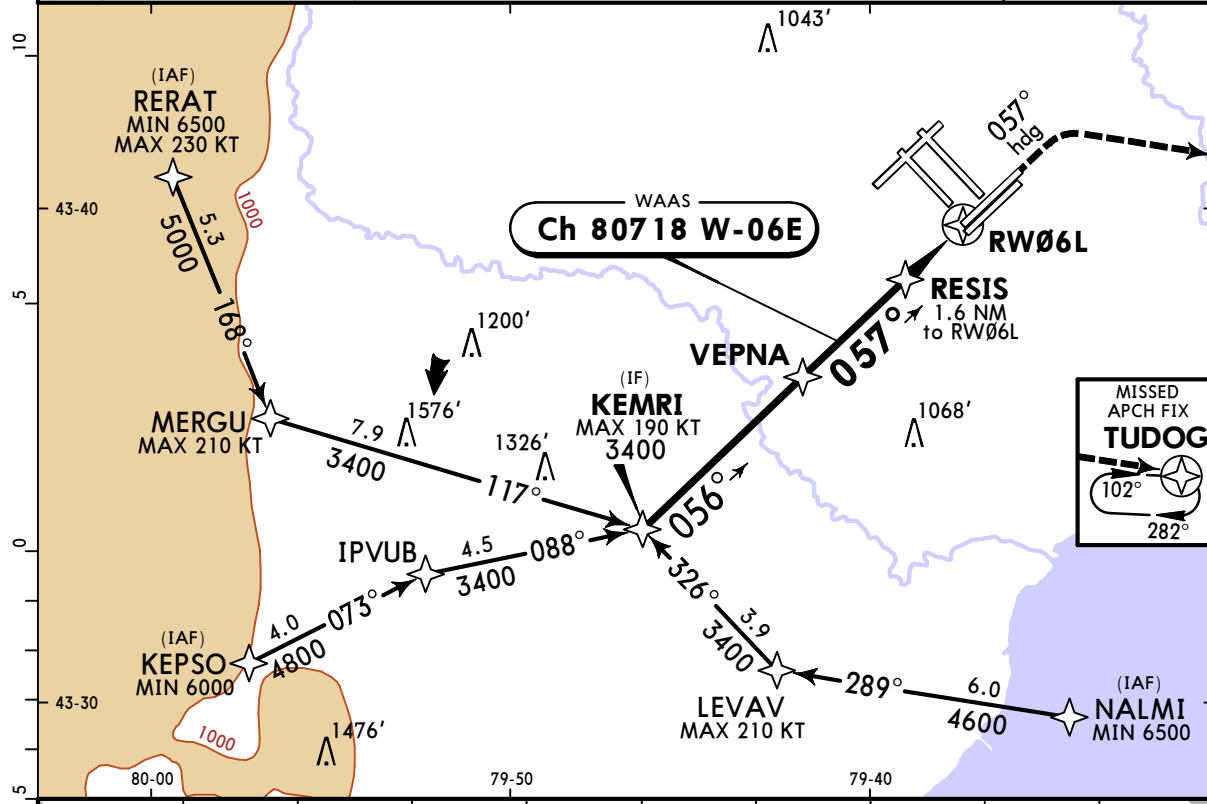

NM to RW06L	9.0	8.0	7.0	6.0	5.0	4.0	3.0	2.0	1.2
VDA ALTITUDE	3400'	3130'	2810'	2490'	2170'	1850'	1540'	1220'	960'

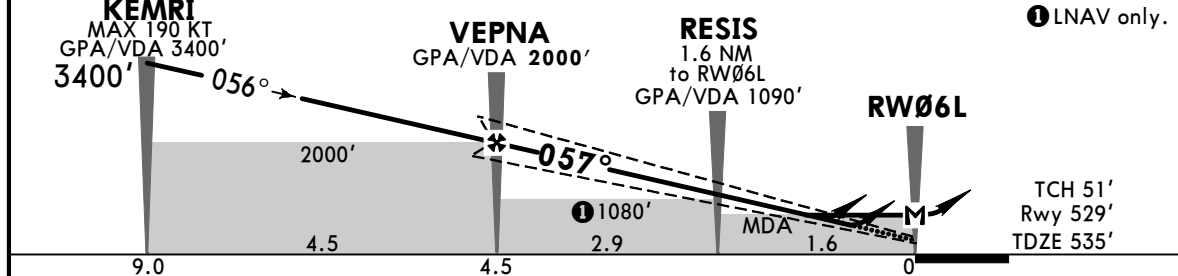

Gnd speed-Kts	70	90	100	120	140	160	ALSIF-II PAPI	1100'	057° hdg
GPA/VDA	3.00°	372	478	531	637	849			

State	LPV		STRAIGHT-IN LANDING LNAV/VNAV			LNAV
	DA(H) 730' (201')	DA(H) 779' (250')	DA(H) 877' (348')			MDA(H) 960' (431')
	HIALS out		HIALS out			HIALS out
A						
B						
C	R26 or V1/2	R50 or V1	R50 or V1	V1 1/4	R50 or V1	V1 1/4
D						

CYYZ/YYZ
LESTER B PEARSON INTL

JEPPESSEN
28 APR 23 (12-5)

TORONTO, ONT
RNAV (GNSS) Z Rwy 06R

D-ATIS	LONDON Radio	TORONTO Arrival			TORONTO Tower	Ground	
120.825 133.1	123.275	132.8	124.475	125.4	118.35 118.7	121.9 121.65 119.1	
WAAS Ch 80631 W-06D	Final Apch Crs 057°	GPA SAVOS 2000' (1475')	LPV DA(H) Refer to Minimums	Apt Elev 569' Rwy 525'			
MISSED APCH: Climb to 1100' heading 057°. Then climbing RIGHT turn to 3100' direct to TUDOG.							
Alt Set: INCHES Trans level: FL180 Trans alt: 18000'							
1. SAFE ALTITUDE WITHIN 100 NM 4900'. 2. Simultaneous approach authorized with Rwy 05. 3. LNAV procedure not authorized during simultaneous operations. 4. For uncompensated Baro-VNAV systems, LNAV/VNAV not authorized below -18°C (0°F) and above 54°C (129°F).							

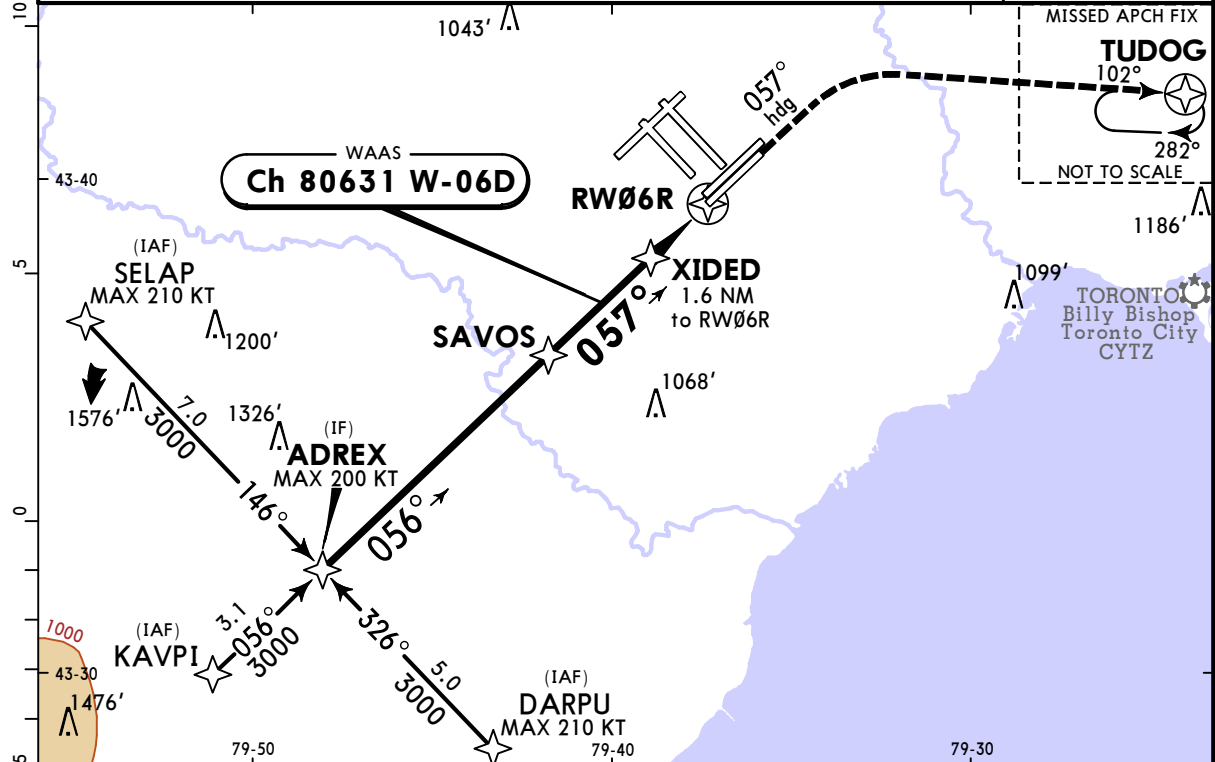

NM to RW06R	10.7	10.0	9.0	7.6	7.0	6.0	5.0	4.0	3.0	2.0	1.2
VDA ALTITUDE	4010'	3770'	3450'	3000'	2810'	2490'	2180'	1860'	1540'	1220'	960'

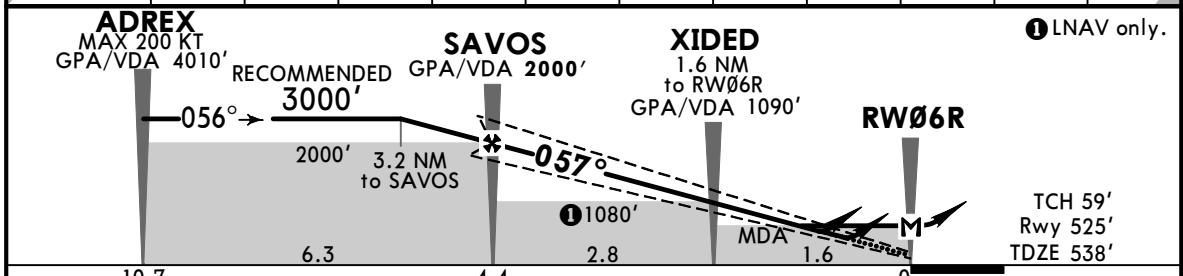

Gnd speed-Kts	70	90	100	120	140	160	SSALR	1100'	057° hdg
GPA/VDA	3.00°	372	478	531	637	849			
MAP at RW06R							PAPI		

State	STRAIGHT-IN LANDING				
	LPV		LNAV/VNAV		LNAV
	DA(H) 725' (201')	DA(H) 774' (250')	DA(H) 827' (303')		MDA(H) 960' (436')
	HIALS out		HIALS out		HIALS out
A					
B					
C	R26 or V1/2	R50 or V1	R50 or V1	R50 or V1	V1 1/2
D					

CYYZ/YYZ
LESTER B PEARSON INTL



TORONTO, ONT
RNAV (GNSS) X Rwy 06R

28 APR 23 (12-6)

D-ATIS	LONDON Radio	TORONTO Arrival			TORONTO Tower		Ground		
120.825 133.1	123.275	132.8	124.475	125.4	118.35	118.7	121.9	121.65	119.1
WAAS Ch 80719 W-06B	Final Apch Crs 057°	GPA SAVOS 2000' (1475')	LPV DA(H) Refer to Minimums	Apt Elev 569' Rwy 525'					
MISSED APCH: Climb to 1100' heading 057°. Then climbing RIGHT turn to 3100' direct to TUDOG.									
Alt Set: INCHES Trans level: FL180 Trans alt: 18000'									
1. SAFE ALTITUDE WITHIN 100 NM 4900'. 2. Simultaneous approach authorized with Rwy 05. 3. LNAV procedure not authorized during simultaneous operations. 4. For uncompensated Baro-VNAV systems, LNAV/VNAV not authorized below -18°C (0°F) and above 54°C (129°F).					MSA RW06R				

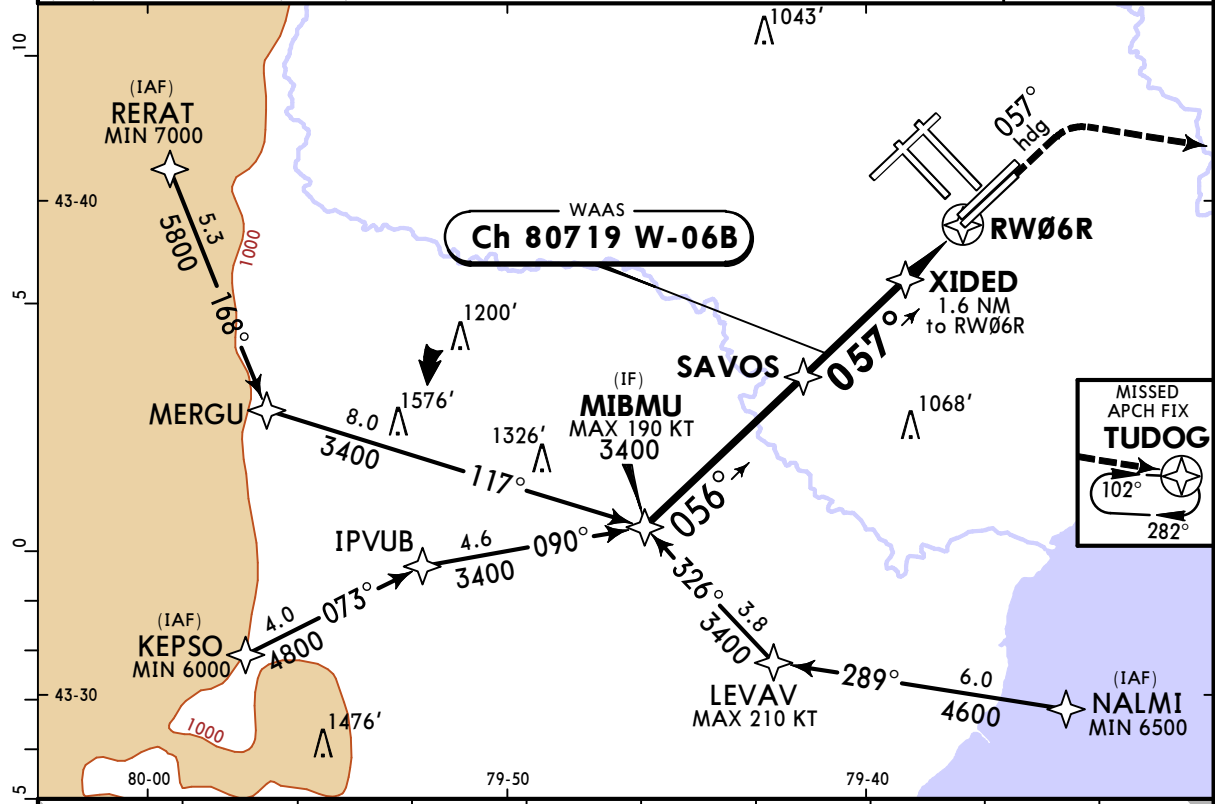

NM to RW06R	8.8	8.0	7.0	6.0	5.0	4.0	3.0	2.0	1.2
VDA ALTITUDE	3400'	3130'	2810'	2490'	2180'	1860'	1540'	1220'	960'

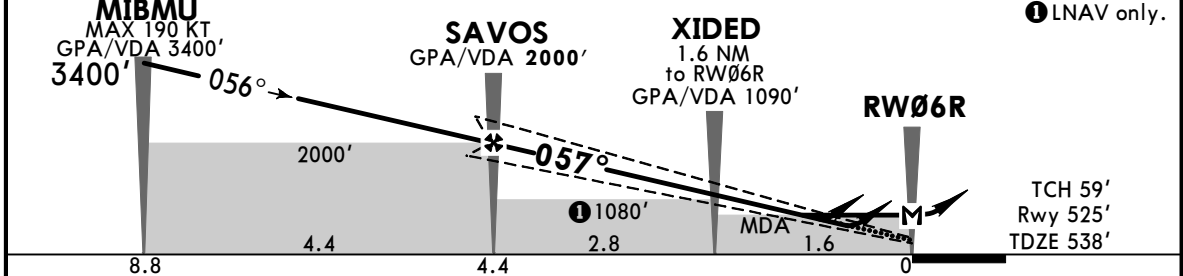

Gnd speed-Kts	70	90	100	120	140	160	SSALR	1100'	057° hdg
GPA/VDA	3.00°	372	478	531	637	849			

State		STRAIGHT-IN LANDING		
LPV		LNAV/VNAV		LNAV
DA(H) 725' (201')		DA(H) 827' (303')		MDA(H) 960' (436')
HIALS out		HIALS out		HIALS out
A				
B				
C	R26 or V1/2	R50 or V1	R50 or V1	R50 or V1
D				V1 1/2

CYYZ/YYZ LESTER B PEARSON INTL

JEPPESSEN
28 APR 23 (12-7)

TORONTO, ONT RNAV (GNSS) Z Rwy 15L

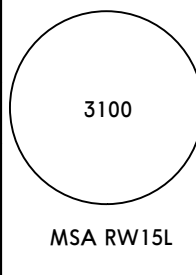
D-ATIS	LONDON Radio	TORONTO Arrival			TORONTO Tower	Ground		
120.825 133.1	123.275	132.8	124.475	125.4	118.35 118.7	121.9	121.65	119.1
WAAS Ch 80632 W-15A	Final Apch Crs 147°	GPA SEKUR 2000' (1443')	LPV DA(H) Refer to Minimums	Apt Elev 569' Rwy 557'				
MISSED APCH: Climb to 1100' heading 147°. Then climbing LEFT turn to 3100' direct to TUDOG.								
Alt Set: INCHES Trans level: FL180 Trans alt: 18000'								
<p>1. SAFE ALTITUDE WITHIN 100 NM 4900'. 2. Simultaneous approach authorized with Rwy 15R. 3. LNAV procedure not authorized during simultaneous operations. 4. Low TCH. Aircraft with eye-to-wheel height at or greater than 22' need to exercise caution. 5. For uncompensated Baro-VNAV systems, LNAV/VNAV not authorized below -21°C (-6°F) and above 54°C (129°F).</p>								

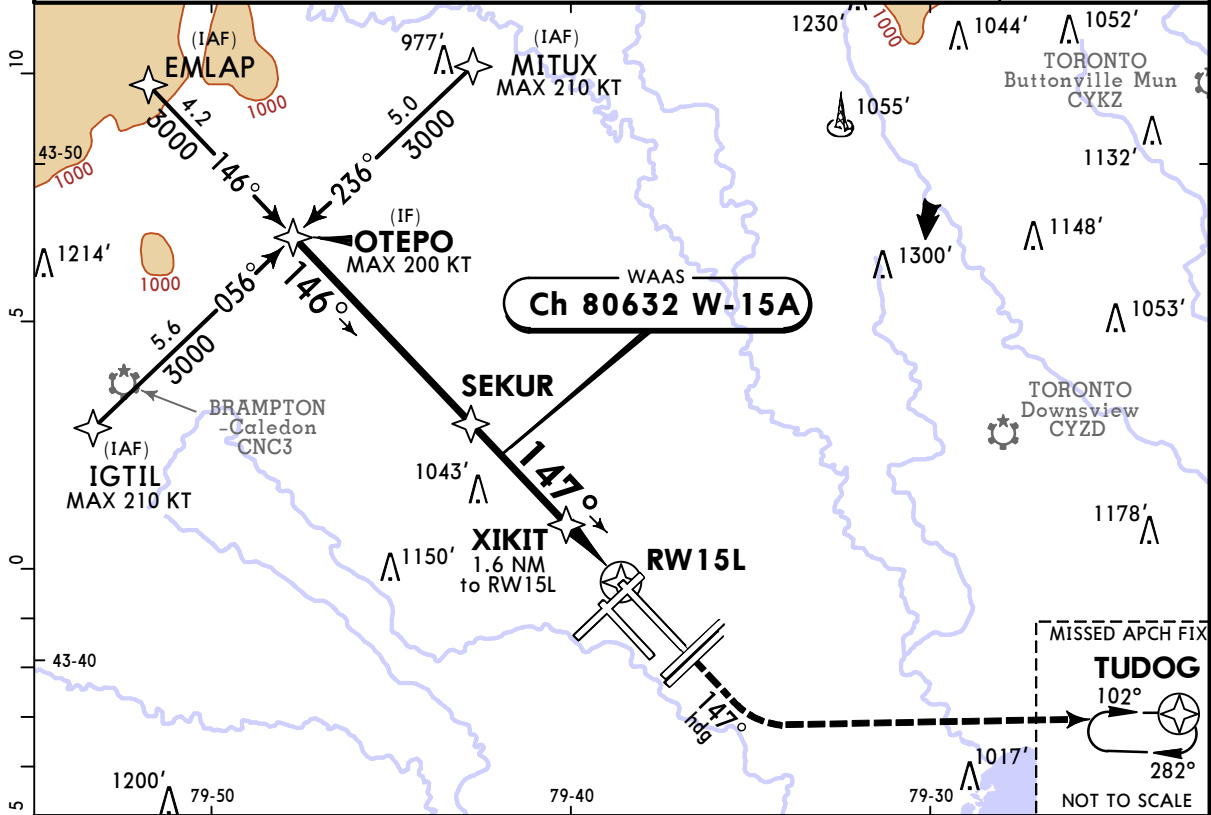

NM to RW15L	9.6	9.0	7.5	7.0	6.0	5.0	4.0	3.0	2.0	1.2
VDA ALTITUDE	3650'	3460'	3000'	2830'	2510'	2190'	1870'	1550'	1230'	980'

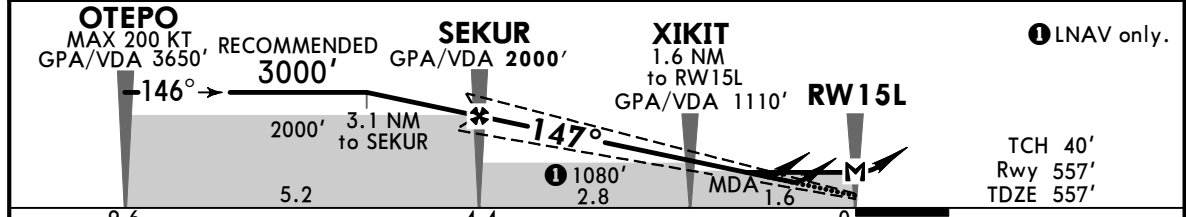

Gnd speed-Kts	70	90	100	120	140	160	SSALR PAPI	1100'	147° hdg
GPA/VDA	3.00°	372	478	531	637	743			
MAP at RW15L									

State	STRAIGHT-IN LANDING					
	LPV		LNAV/VNAV		LNAV	
	DA(H) 757' (200')	DA(H) 807' (250')	DA(H) 977' (420')		MDA(H) 980' (423')	
	HIALS out		HIALS out		HIALS out	
A						
B						
C	R26 or V1/2	R50 or V1	R50 or V1	V1 1/4	R50 or V1	V1 1/4
D						

CHANGES: Airport name, new AOM concept.

CYYZ/YYZ LESTER B PEARSON INTL

JEPPESSEN
28 APR 23 (12-8)

TORONTO, ONT RNAV (GNSS) Z Rwy 15R

D-ATIS 120.825 133.1		LONDON Radio 123.275	TORONTO Arrival 132.8 124.475 125.4			TORONTO Tower 118.35 118.7		Ground 121.9 121.65 119.1		
WAAS Ch 80633 W-15D		Final Apch Crs 147°	GPA HOFFS 2000' (1448')		LPV DA(H) Refer to Minimums	Apt Elev 569' Rwy 552'				
MISSED APCH: Climb to 1100' heading 147°. Then climbing RIGHT turn to 3000' direct to PETVO.										
Alt Set: INCHES			Trans level: FL180			Trans alt: 18000'				
1. SAFE ALTITUDE WITHIN 100 NM 4900'. 2. Simultaneous approach authorized with Rwy 15L. 3. LNAV procedure not authorized during simultaneous operations. 4. For uncompensated Baro-VNAV systems, LNAV/VNAV not authorized below -19°C (-2°F) and above 54°C (129°F).										

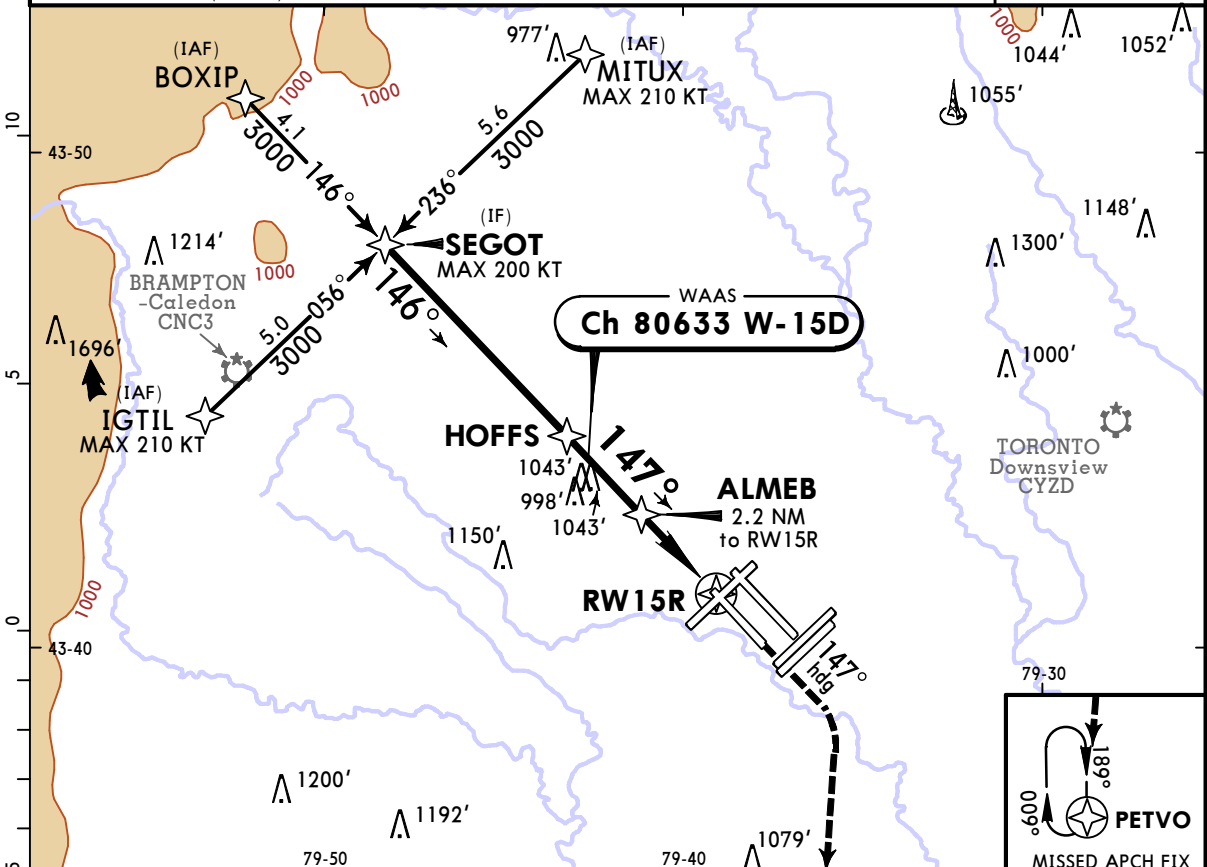

NM to RW15R	9.7	9.0	7.5	7.0	6.0	5.0	4.0	3.0	2.0	1.2
VDA ALTITUDE	3700'	3470'	3000'	2830'	2510'	2200'	1880'	1560'	1240'	980'

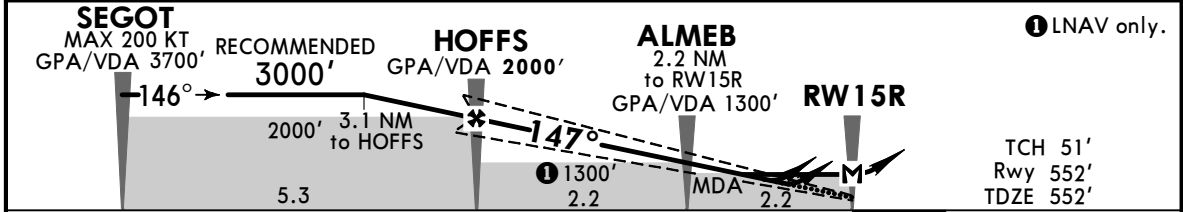

Gnd speed-Kts	70	90	100	120	140	160	SSALR PAPI	1100'	147° hdg
GPA/VDA	372	478	531	637	743	849			
MAP at RW15R									

State					STRAIGHT-IN LANDING				
LPV		LNAV/VNAV			LNAV				
DA(H) 752' (201')		DA(H) 847' (296')			MDA(H) 980' (429')				
HIALS out		HIALS out			HIALS out				
A									
B	R26 or V1/2	R50 or V1	R50 or V1	R50 or V1	R50 or V1	R50 or V1	R50 or V1	V1 1/4	
C									
D									

CHANGES: Airport name, new AOM concept.

CYYZ/YYZ LESTER B PEARSON INTL

JEPPESSEN
28 APR 23 (12-9)

TORONTO, ONT RNAV (GNSS) Z Rwy 23

D-ATIS	LONDON Radio	TORONTO Arrival			TORONTO Tower		Ground		
120.825 133.1	123.275	132.8	124.475	125.4	118.35	118.7	121.9	121.65	119.1
WAAS Ch 80634 W-23A	Final Apch Crs 237°	GPA OMTOK 2000' (1443')	LPV DA(H) 808' (250')	Apt Elev 569' Rwy 557'		<p>3100 MSA RW23</p>			
MISSED APCH: Climb to 1100' heading 237°. Then climbing RIGHT turn to 3000' direct to IKDOT.									
Alt Set: INCHES Trans level: FL180 Trans alt: 18000'									
1. SAFE ALTITUDE WITHIN 100 NM 4900'. 2. Simultaneous approach authorized with Rwy 24L or 24R. 3. LNAV procedure not authorized during simultaneous operations. 4. For uncompensated Baro-VNAV systems, LNAV/VNAV not authorized below -23°C (-9°F) and above 45°C (113°F).									

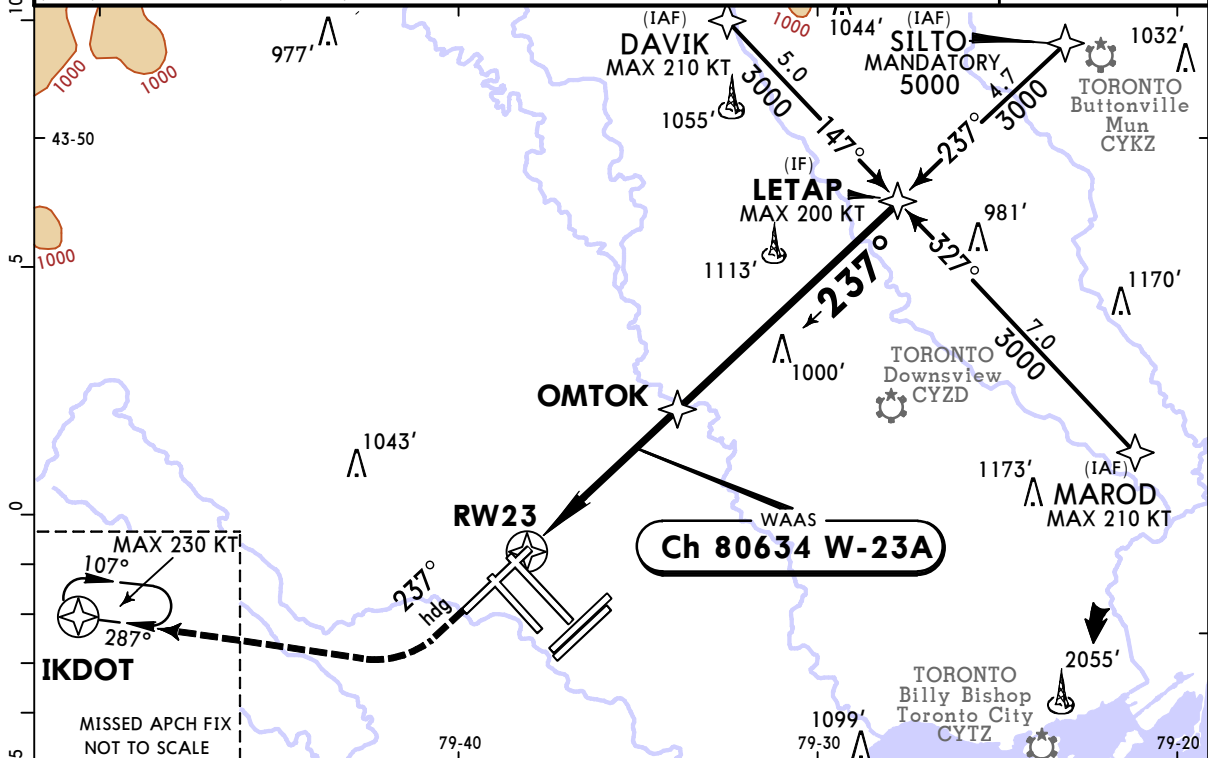

NM to RW23	1.1	2.0	3.0	4.0	5.0	6.0	7.2	8.0	9.0	10.3
VDA ALTITUDE	980'	1270'	1600'	1930'	2260'	2590'	3000'	3250'	3580'	4010'

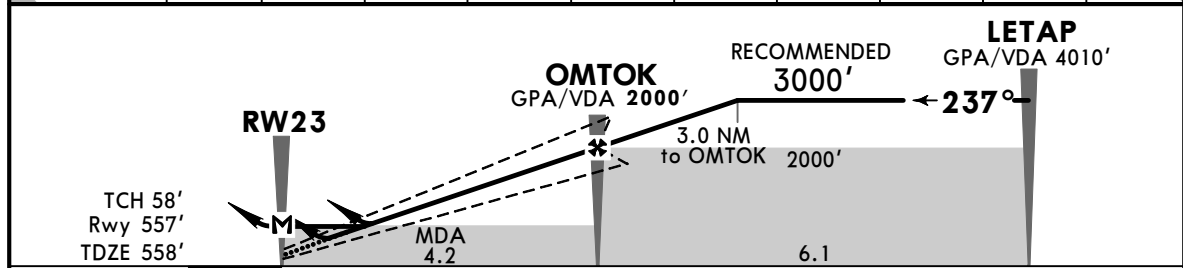

Gnd speed-Kts	70	90	100	120	140	160	SSALR PAPI	1100'	237° hdg
GPA/VDA	3.10°	384	494	548	658	878			
MAP at RW23									

State	STRAIGHT-IN LANDING				
	LPV	LNAV/VNAV		LNAV	
	DA(H) 808' (250')	DA(H) 990' (433')		MDA(H) 980' (423')	
	HIALS out	HIALS out		HIALS out	
A					
B					
C	R50 or V1	R50 or V1	V1 1/4	R50 or V1	V1 1/4
D					

CYYZ/YYZ LESTER B PEARSON INTL

JEPPESSEN
28 APR 23 (12-10)

TORONTO, ONT RNAV (GNSS) X Rwy 23

D-ATIS	LONDON Radio	TORONTO Arrival			TORONTO Tower		Ground		
120.825 133.1	123.275	132.8	124.475	125.4	118.35	118.7	121.9	121.65	119.1
WAAS Ch 80720 W-23B	Final Apch Crs 237°	GPA OMTOK 2000' (1443')	LPV DA(H) 808' (250')	Apt Elev 569'	Rwy 557'				
MISSED APCH: Climb to 1100' heading 237°. Then climbing RIGHT turn to 3000' direct to IKDOT.								3100	
Alt Set: INCHES		Trans level: FL180			Trans alt: 18000'				
1. SAFE ALTITUDE WITHIN 100 NM 4900'. 2. Simultaneous approach authorized with Rwy 24L or 24R. 3. LNAV procedure not authorized during simultaneous operations. 4. For uncompensated Baro-VNAV systems, LNAV/VNAV not authorized below -23°C (-9°F) and above 45°C (113°F).								MSA RW23	

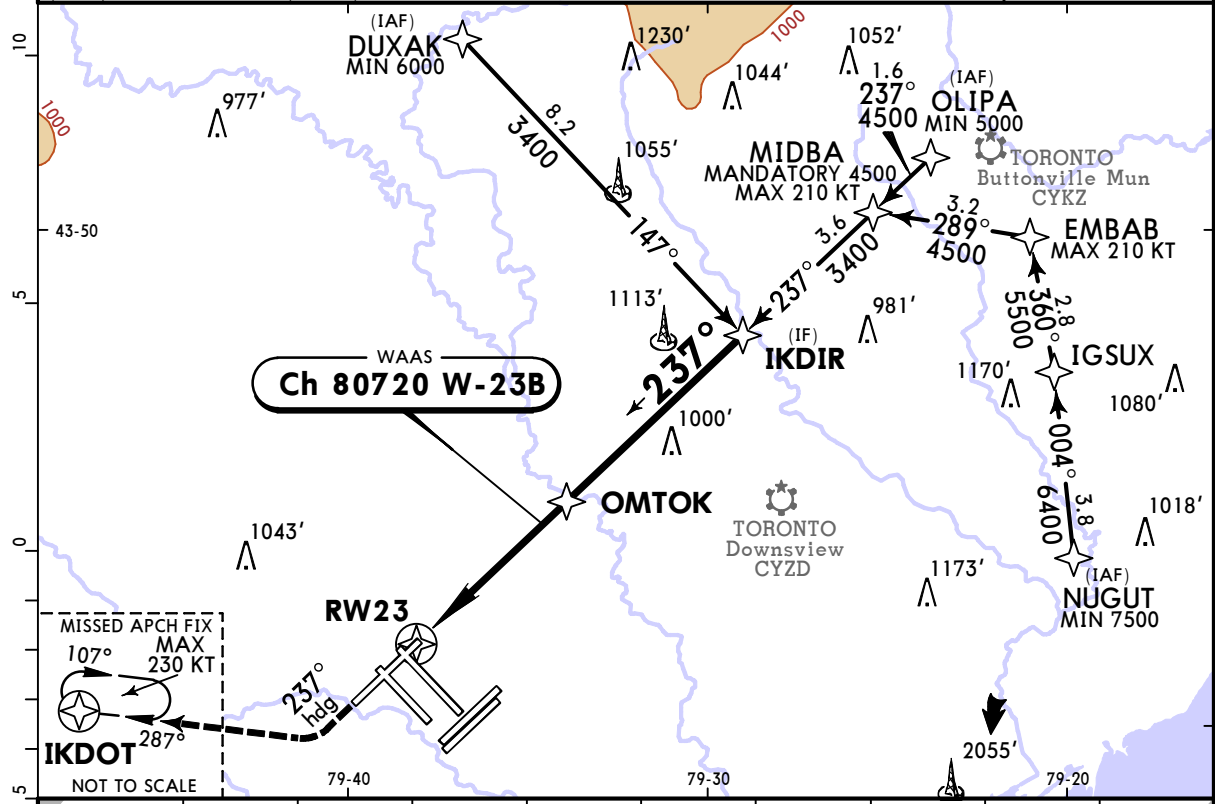

NM to RW23	1.1	2.0	3.0	4.0	5.0	6.0	7.0	8.5	9.1
VDA ALTITUDE	980'	1270'	1600'	1930'	2260'	2590'	2920'	3400'	3610'

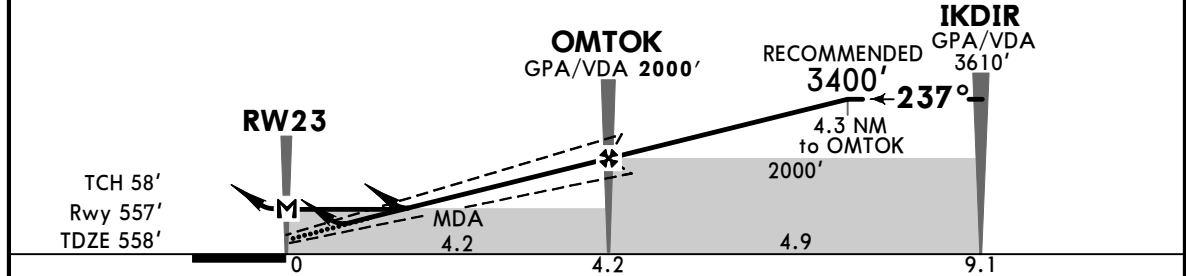

Gnd speed-Kts	70	90	100	120	140	160	SSALR PAPI	1100'	237° hdg
GPA/VDA	3.10°	384	494	548	658	768			

State					STRAIGHT-IN LANDING					
LPV DA(H) 808' (250')		LNAV/VNAV DA(H) 990' (433')			LNAV MDA(H) 980' (423')					
HIALS out		HIALS out			HIALS out		HIALS out			
A	R50 or V1		R50 or V1		V1 1/4		R50 or V1		V1 1/4	
B										
C										
D										

CYYZ/YYZ
LESTER B PEARSON INTL

JEPPESSEN
28 APR 23 **(12-11)**

TORONTO, ONT
RNAV (GNSS) Z Rwy 24L

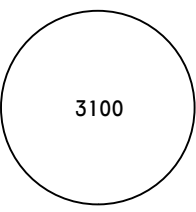
D-ATIS	LONDON Radio	TORONTO Arrival			TORONTO Tower		Ground			
120.825 133.1	123.275	132.8	124.475	125.4	118.35	118.7	121.9	121.65 119.1		
WAAS Ch 80635 W-24A	Final Apch Crs 237°	GPA KIREX 2000' (1453')	LPV DA(H) Refer to Minimums	Apt Elev 569' Rwy 547'		 <p>3100</p> <p>MSA RW24L</p>				
MISSED APCH: Climb to 1100' heading 237°. Then climbing LEFT turn to 3000' direct to PETVO.										
Alt Set: INCHES		Trans level: FL180			Trans alt: 18000'					
1. SAFE ALTITUDE WITHIN 100 NM 4900'. 2. Simultaneous approach authorized with Rwy 23. 3. LNAV procedure not authorized during simultaneous operations. 4. For uncompensated Baro-VNAV systems, LNAV/VNAV not authorized below -23°C (-9°F) and above 45°C (113°F).										

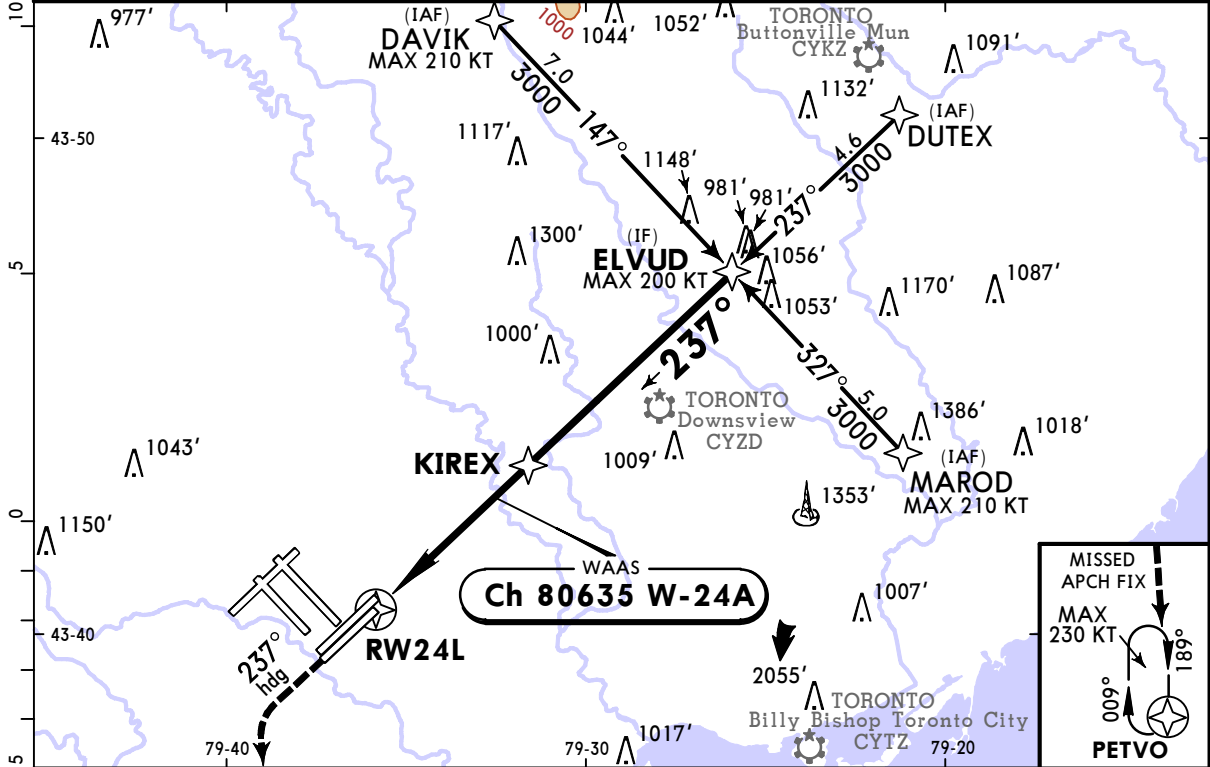

NM to RW24L	1.4	2.0	3.0	4.0	5.0	6.0	7.3	8.0	9.0	9.9
VDA ALTITUDE	1060'	1260'	1590'	1920'	2250'	2580'	3000'	3240'	3570'	3860'

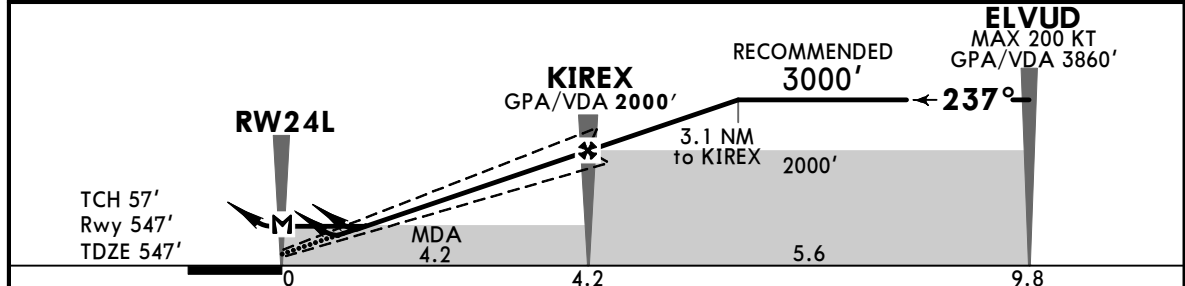

Gnd speed-Kts	70	90	100	120	140	160	SSALR	1100'	237° hdg
GPA/VDA	3.10°	384	494	548	658	768			
MAP at RW24L									

State	STRAIGHT-IN LANDING					
	LPV		LNAV/VNAV		LNAV	
	DA(H) 747' (200')	DA(H) 797' (250')	DA(H) 953' (407')		MDA(H) 1060' (514')	
	HIALS out		HIALS out		HIALS out	
A						
B						
C	R26 or V1/2	R50 or V1	R50 or V1	V1 1/4	R50 or V1	V1 1/2
D						

CYYZ/YYZ
LESTER B PEARSON INTL

JEPPESSEN
28 APR 23 **(12-12)**

TORONTO, ONT
RNAV (GNSS) X Rwy 24L

D-ATIS	LONDON Radio	TORONTO Arrival			TORONTO Tower		Ground	
120.825 133.1	123.275	132.8	124.475	125.4	118.35	118.7	121.9	121.65 119.1
WAAS Ch 80721 W-24E	Final Apch Crs 237°	GPA KIREX 2000' (1453')	LPV DA(H) Refer to Minimums	Apt Elev 569' Rwy 547'		3100		
MISSED APCH: Climb to 1100' heading 237°. Then climbing LEFT turn to 3000' direct to PETVO.								
Alt Set: INCHES		Trans level: FL180			Trans alt: 18000'			
1. SAFE ALTITUDE WITHIN 100 NM 4900'. 2. Simultaneous approach authorized with Rwy 23. 3. LNAV procedure not authorized during simultaneous operations. 4. For uncompensated Baro-VNAV systems, LNAV/VNAV not authorized below -23°C (-9°F) and above 45°C (113°F).								
MSA RW24L								

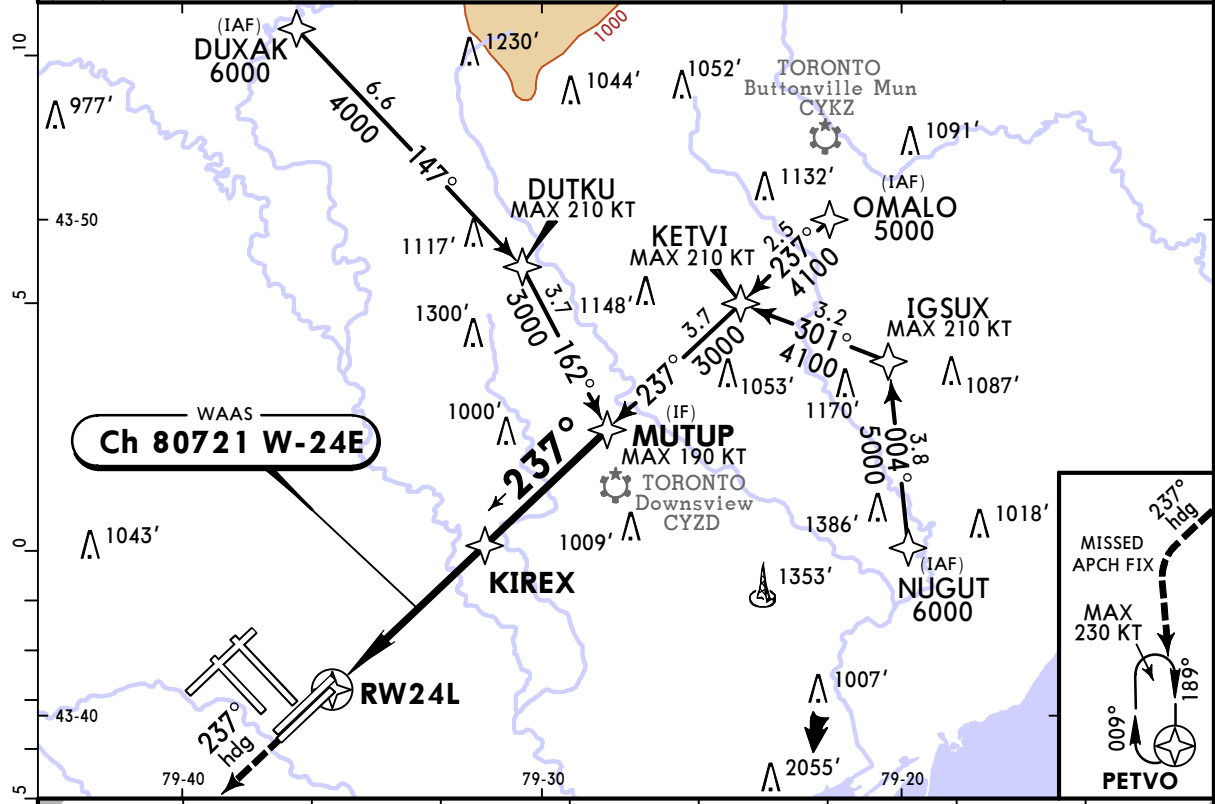

NM to RW24L	1.4	2.0	3.0	4.0	5.0	6.0	7.3	7.6
VDA ALTITUDE	1060'	1260'	1590'	1920'	2250'	2580'	3000'	3120'

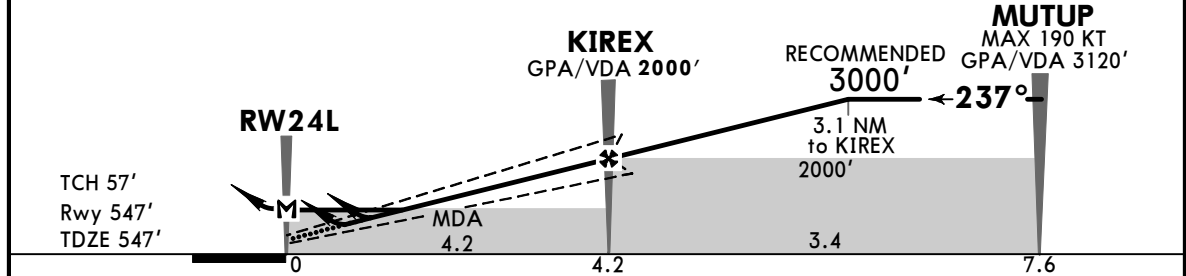

Gnd speed-Kts	70	90	100	120	140	160	SSALR PAPI	1100'	237° hdg
GPA/VDA	3.10°	384	494	548	658	768			
MAP at RW24L									

State	STRAIGHT-IN LANDING					
	LPV		LNAV/VNAV		LNAV	
	DA(H) 747' (200')	DA(H) 797' (250')	DA(H) 953' (407')	MDA(H) 1060' (514')		
	HIALS out		HIALS out		HIALS out	
A						
B						
C	R26 or V1/2	R50 or V1	R50 or V1	V1 1/4	R50 or V1	V1 1/2
D						

CYYZ/YYZ LESTER B PEARSON INTL

JEPPESSEN
28 APR 23 (12-13)

TORONTO, ONT RNAV (GNSS) Z Rwy 24R

D-ATIS 120.825 133.1	LONDON Radio 123.275	TORONTO Arrival 132.8 124.475 125.4			TORONTO Tower 118.35 118.7	Ground 121.9 121.65 119.1
WAAS Ch 80636 W-24D	Final Apch Crs 237°	GPA NOAHA 2000'(1454')	LPV DA(H) 796'(250')	Apt Elev 569' Rwy 546'		
MISSED APCH: Climb to 1100' heading 237°. Then climbing LEFT turn to 3000' direct to PETVO.						
Alt Set: INCHES Trans level: FL180 Trans alt: 18000' 1. CAUTION: Twy Charlie (600' right of centerline) similar in appearance to rwy. 2. SAFE ALTITUDE WITHIN 100 NM 4900'. 3. Simultaneous approach authorized with Rwy 23. 4. LNAV procedure not authorized during simultaneous operations. 5. For uncompensated Baro-VNAV systems, LNAV/VNAV not authorized below -23°C (-9°F) and above 45°C (113°F).						

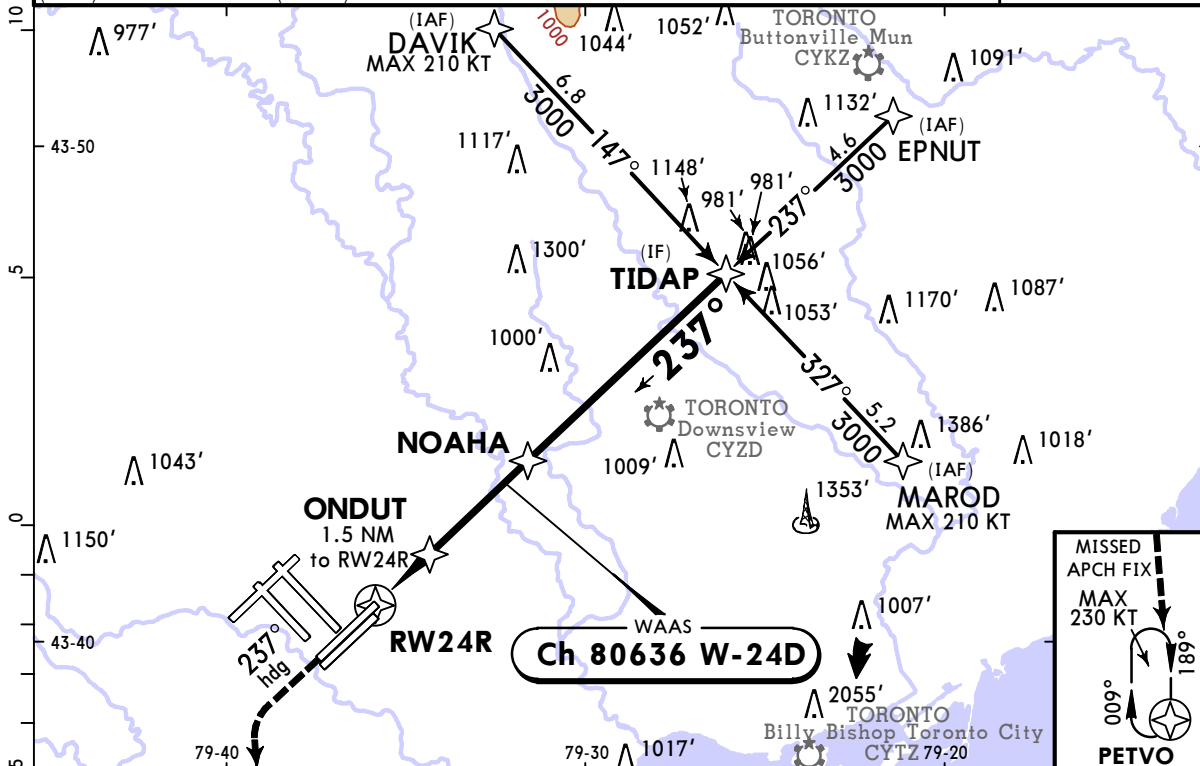

NM to RW24R	1.1	2.0	3.0	4.0	5.0	6.0	7.3	8.0	9.0	9.7
VDA ALTITUDE	980'	1260'	1590'	1920'	2250'	2580'	3000'	3240'	3570'	3810'

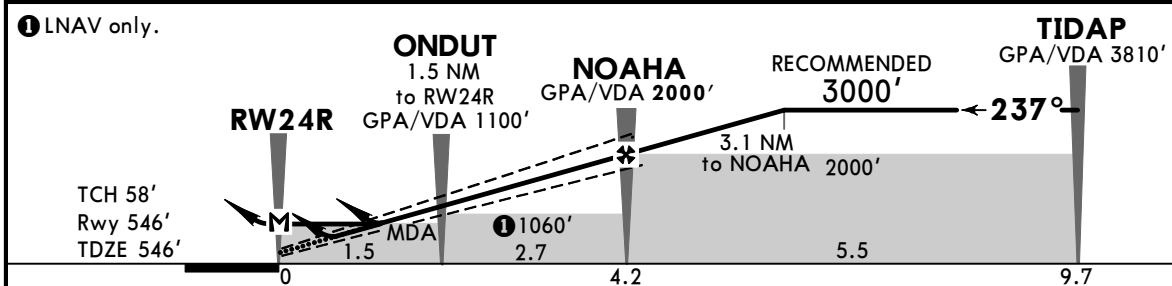

Gnd speed-Kts	70	90	100	120	140	160	SSALS REIL PAPI	1100'	237° hdg
GPA/VDA	3.10°	384	494	548	658	768			
MAP at RW24R									

State				STRAIGHT-IN LANDING				
LPV		LNAV/VNAV		LNAV				
DA(H) 796'(250')		DA(H) 1028'(482')		MDA(H) 980'(434')				
HIALS out		HIALS out		HIALS out				
A								
B								
C	R50 or V1		V1 1/2		V1 1/4			
D								

CYYZ/YYZ LESTER B PEARSON INTL

JEPPesen
28 APR 23 **(12-14)**

TORONTO, ONT RNAV (GNSS) X Rwy 24R

D-ATIS	LONDON Radio	TORONTO Arrival			TORONTO Tower	Ground	
120.825 133.1	123.275	132.8	124.475	125.4	118.35 118.7	121.9 121.65 119.1	
WAAS Ch 80722 W-24B	Final Apch Crs 237°	GPA NOAHA 2000' (1454')	LPV DA(H) 796' (250')	Apt Elev 569' Rwy 546'			
MISSED APCH: Climb to 1100' heading 237°. Then climbing LEFT turn to 3000' direct to PETVO.							
Alt Set: INCHES Trans level: FL180 Trans alt: 18000'							
1. CAUTION: Taxiway Charlie (600' right of centerline) similar in appearance to rwy. 2. SAFE ALTITUDE WITHIN 100 NM 4900'. 3. Simultaneous approach authorized with Rwy 23. 4. LNAV procedure not authorized during simultaneous operations. 5. For uncompensated Baro-VNAV systems, LNAV/VNAV not authorized below -23°C (-9°F) and above 45°C (113°F).							

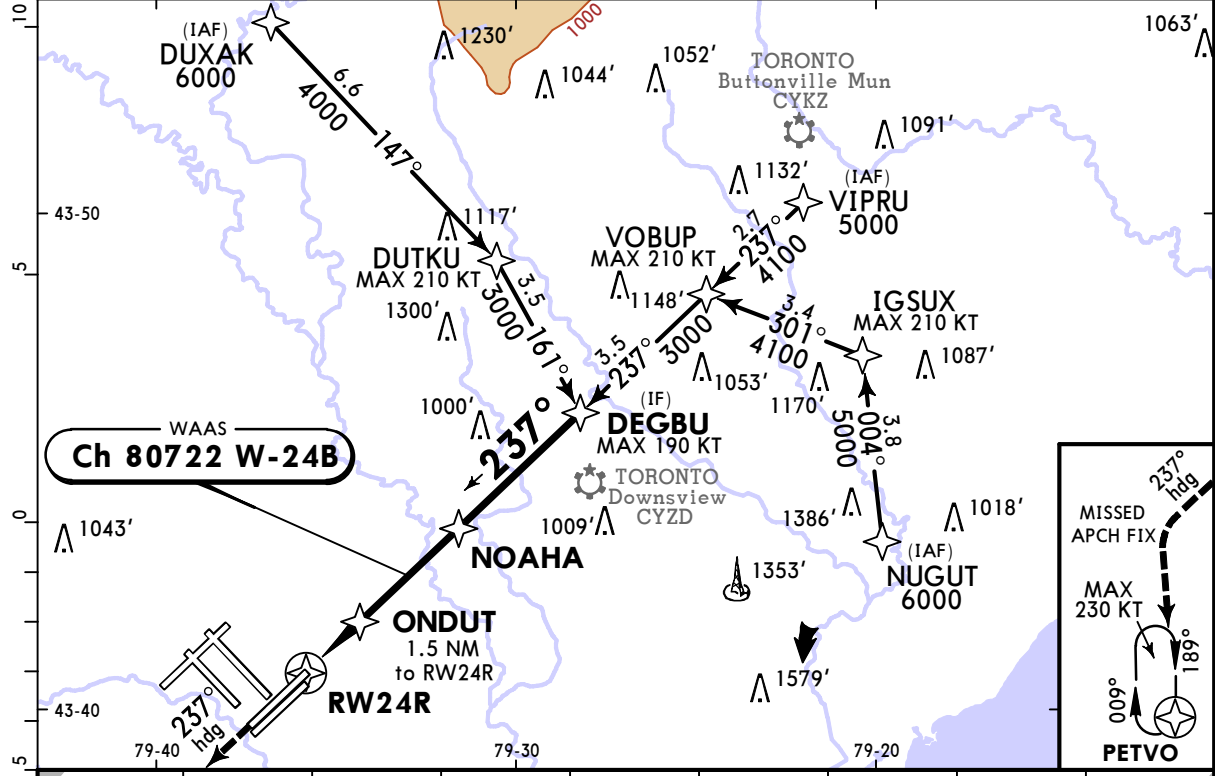

NM to RW24R	1.1	2.0	3.0	4.0	5.0	6.0	7.3	7.6
VDA ALTITUDE	980'	1260'	1590'	1920'	2250'	2580'	3000'	3110'

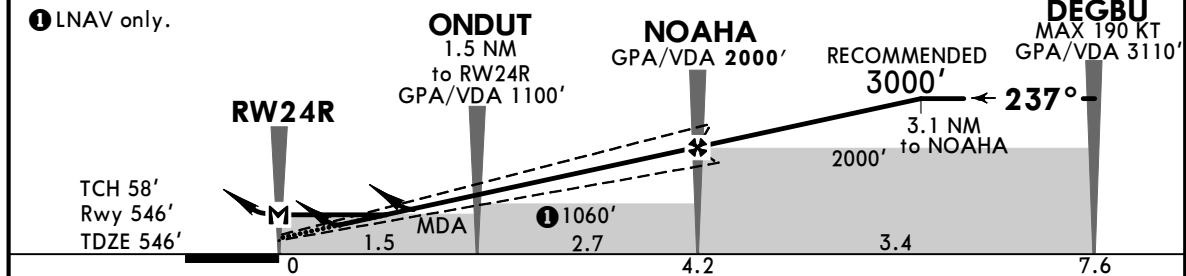

Gnd speed-Kts	70	90	100	120	140	160	SSALS REIL PAPI	1100'	237° hdg
GPA/VDA	3.10°	384	494	548	658	768			

State		STRAIGHT-IN LANDING		
A	LPV	LNAV/VNAV		LNAV
	DA(H) 796' (250')	DA(H) 1028' (482')		MDA(H) 980' (434')
B	HIALS out		HIALS out	
C	R50 or V1	V1 1/2		V1 1/4
D				

CYYZ/YYZ
LESTER B PEARSON INTL

JEPPESSEN
28 APR 23 (12-15)

TORONTO, ONT
RNAV (GNSS) Z Rwy 33L

D-ATIS	LONDON Radio	TORONTO Arrival			TORONTO Tower		Ground				
120.825 133.1	123.275	132.8	124.475	125.4	118.35	118.7	121.9	121.65	119.1		
WAAS Ch 80637 W-33A	Final Apch Crs 327°	GPA APMAM 2000' (1454')	LPV DA(H) 842' (296')	Apt Elev 569' Rwy 546'							
MISSED APCH: Climb to 1100' heading 327°. Then climbing LEFT turn to 3000' direct to IKDOT.											
Alt Set: INCHES		Trans level: FL180								Trans alt: 18000'	
1. SAFE ALTITUDE WITHIN 100 NM 4900'. 2. Simultaneous approach authorized with Rwy 33R. 3. LNAV procedure not authorized during simultaneous operations. 4. For uncompensated Baro-VNAV systems, LNAV/VNAV not authorized below -19°C (-2°F) and above 54°C (129°F).											

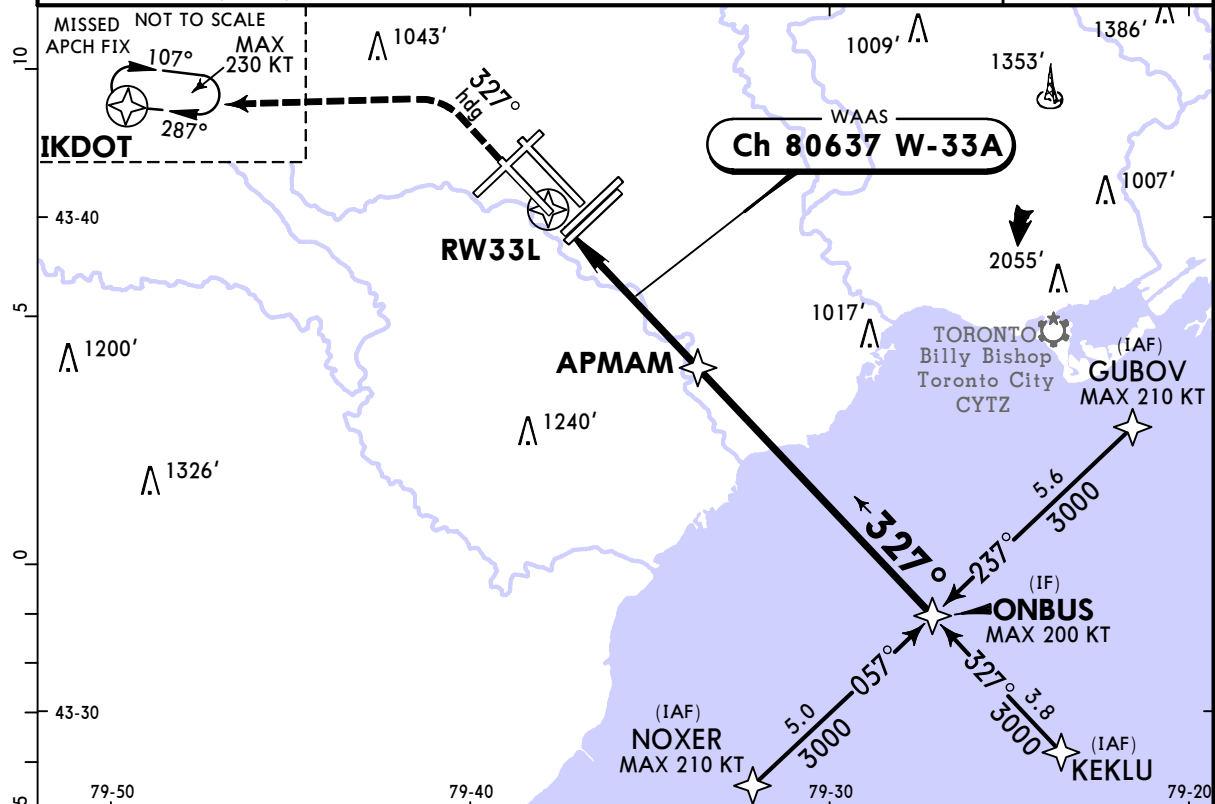

NM to RW33L	1.4	2.0	3.0	4.0	5.0	6.0	7.5	9.0	10.0	11.3
VDA ALTITUDE	1040'	1240'	1560'	1870'	2190'	2510'	3000'	3470'	3790'	4200'

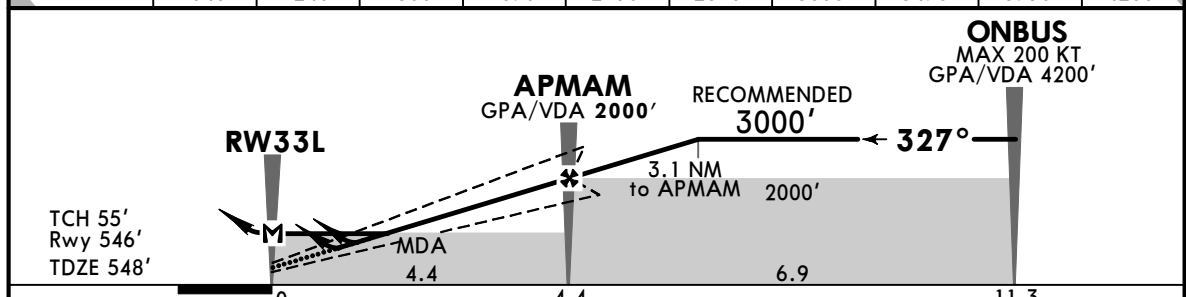

Gnd speed-Kts	70	90	100	120	140	160	SSALR	1100'	327° hdg
GPA/VDA	3.00°	372	478	531	637	743			
MAP at RW33L									

State					STRAIGHT-IN LANDING				
LPV DA(H) 842' (296')		LNAV/VNAV DA(H) 950' (404')			LNAV MDA(H) 1040' (494')				
HIALS out		HIALS out			HIALS out		HIALS out		
A									
B	R50 or V1	R50 or V1	V1 1/4	R50 or V1	V1 1/2				
C									
D									

CYYZ/YYZ
LESTER B PEARSON INTL

JEPPESSEN
28 APR 23 **(12-16)**

TORONTO, ONT
RNAV (GNSS) Z Rwy 33R

D-ATIS 120.825 133.1		LONDON Radio 123.275	TORONTO Arrival 132.8 124.475 125.4			TORONTO Tower 118.35 118.7		Ground 121.9 121.65 119.1				
WAAS Ch 80638 W-33D		Final Apch Crs 327°	GPA LETAG 2000' (1456')	LPV DA(H) Refer to Minimums		Apt Elev 569' Rwy 544'		3100 MSA RW33R				
MISSED APCH: Climb to 1100' heading 327°. Then climbing RIGHT turn to 3000' direct to AVTEK.												
Alt Set: INCHES			Trans level: FL180			Trans alt: 18000'						
1. SAFE ALTITUDE WITHIN 100 NM 4900'. 2. Simultaneous approach authorized with Rwy 33L. 3. LNAV procedure not authorized during simultaneous operations. 4. For uncompensated Baro-VNAV systems, LNAV/VNAV not authorized below -19°C (-2°F) and above 54°C (129°F).												

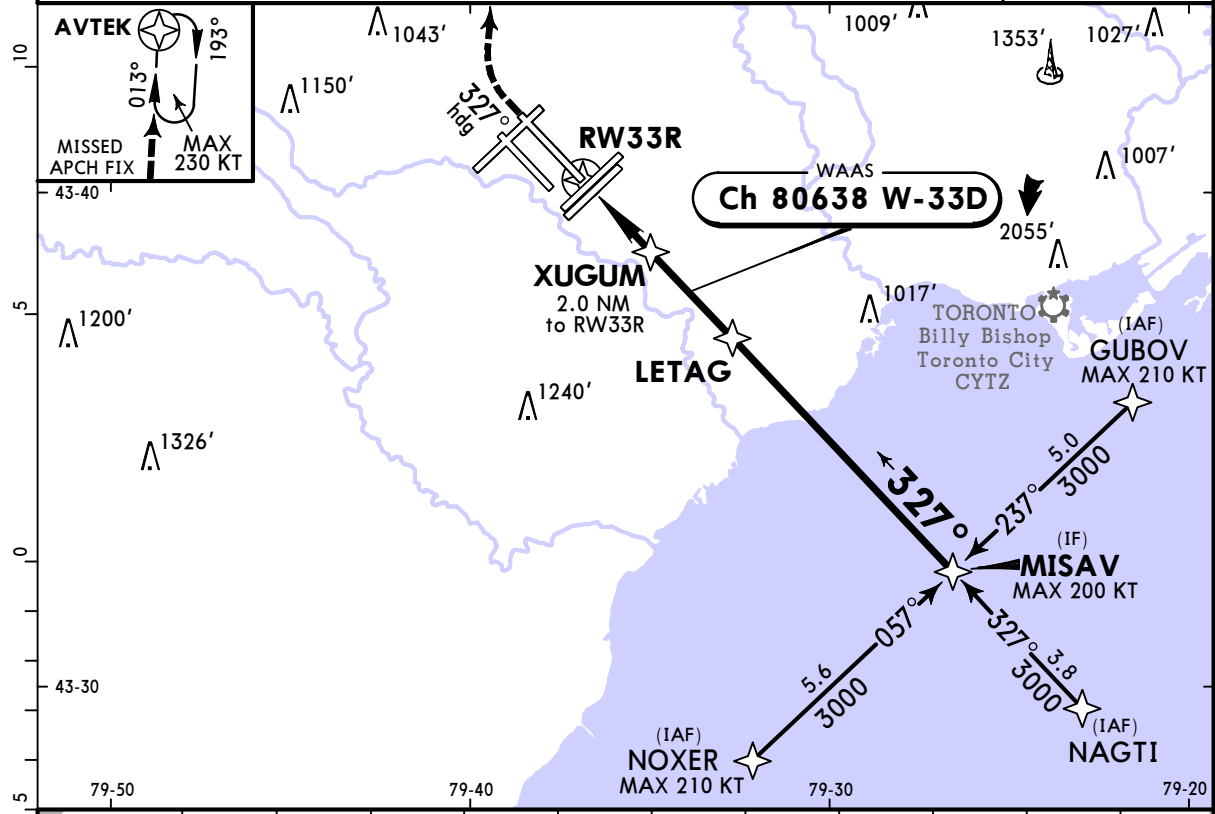

NM to RW33R	1.1	2.0	3.0	4.0	5.0	6.0	7.0	7.5	9.0	10.0	10.9
VDA ALTITUDE	940'	1240'	1550'	1870'	2190'	2510'	2830'	3000'	3470'	3780'	4070'

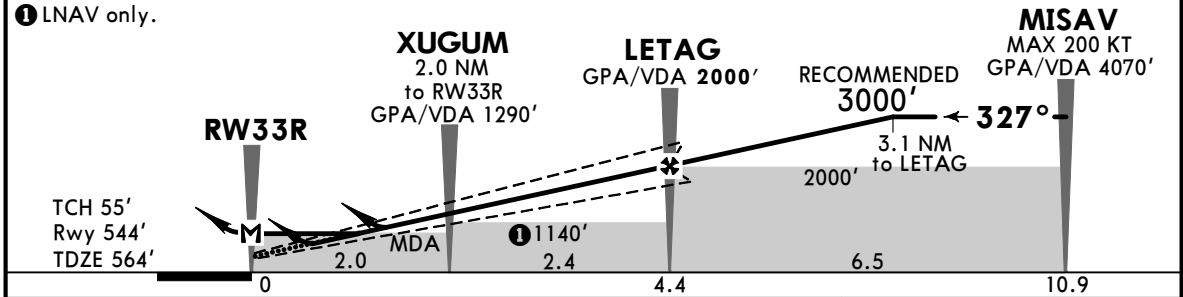

Gnd speed-Kts	70	90	100	120	140	160	SSALR PAPI	1100'	327° hdg
GPA/VDA	372	478	531	637	743	849			
MAP at RW33R									

State						STRAIGHT-IN LANDING					
LPV		LNAV/VNAV				LNAV					
DA(H) 771' (227')		DA(H) 794' (250')				DA(H) 947' (403')				MDA(H) 940' (396')	
HIALS out		HIALS out				HIALS out				HIALS out	
A											
B	R26 or V1/2	R50 or V1	R50 or V1	V1 1/4	R50 or V1	V1 1/4					
C											
D											

CHANGES: Airport name, new AOM concept.

CYYZ/YYZ
LESTER B PEARSON INTL

JEPPESSEN
28 APR 23 **(12-20)**

TORONTO, ONT
RNAV (RNP) Y Rwy 05

D-ATIS	LONDON Radio	TORONTO Arrival			TORONTO Tower		Ground	
120.825 133.1	123.275	132.8	124.475	125.4	118.35	118.7	121.9	121.65 119.1
RNAV	Final Apch Crs 056°	Minimum Alt KOBAL 2500' (1936')	RNP 0.15 DA(H) 863' (300')	Apt Elev 569'	Rwy 564'			
MISSED APCH: Climb to 1100' heading 056°. Then climbing LEFT turn to 3000' direct to AVTEK.							3100	
Alt Set: INCHES		Trans level: FL180			Trans alt: 18000'			
1. AUTHORIZATION REQUIRED. 2. SAFE ALTITUDE WITHIN 100 NM 4900'. 3. Simultaneous approach authorized with Rwy 06L or 06R. 4. See Attention All Users - - Established on RNP AR User Instructions (12-0). 5. For uncompensated Baro-VNAV systems, procedure not authorized below -19°C (-2°F) and above 54°C (129°F).								
							MSA RW05	

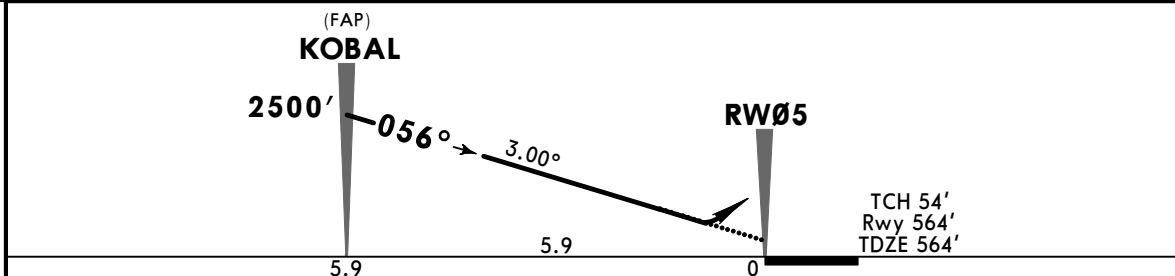
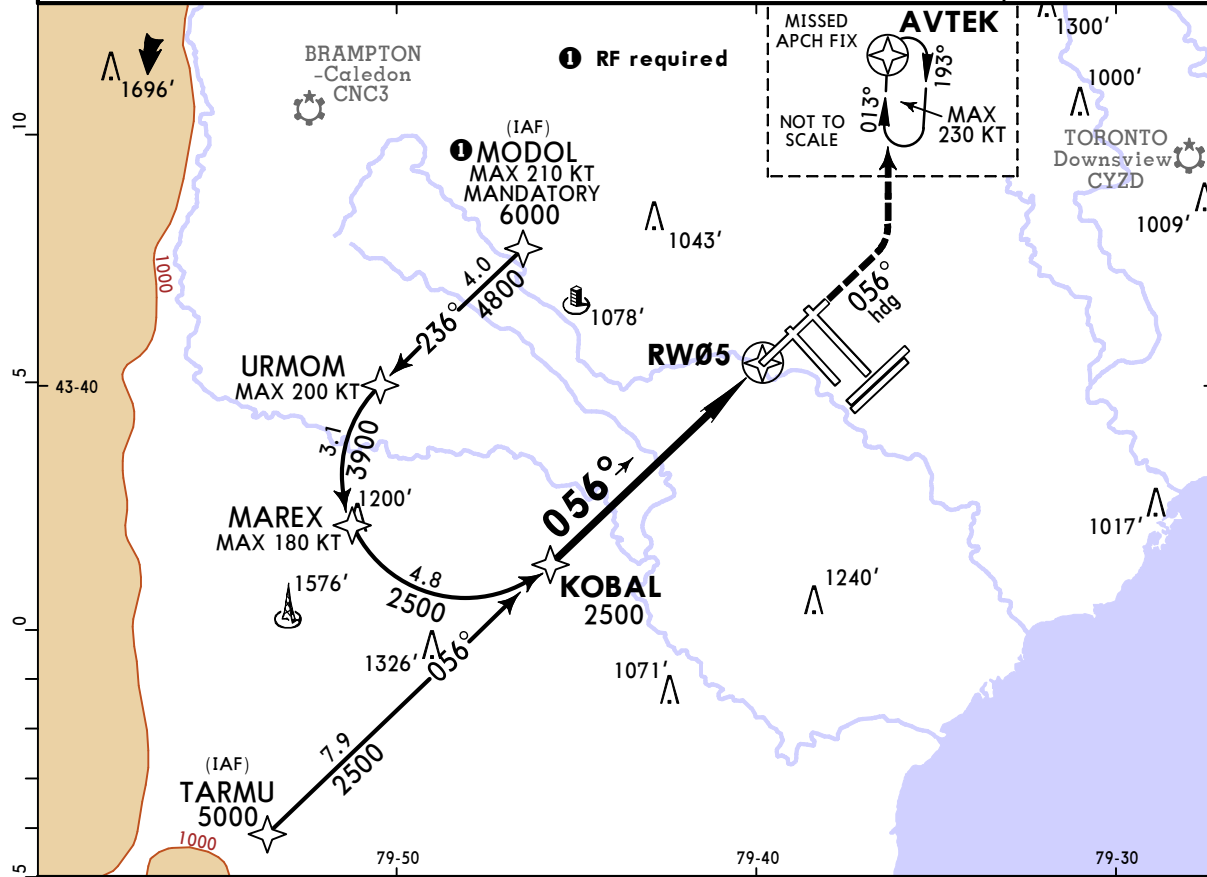

Gnd speed-Kts	70	90	100	120	140	160	ALSF-II PAPI	1100'	056° hdg
Glide Path Angle 3.00°	372	478	531	637	743	849			

State	STRAIGHT-IN LANDING	
	RNP 0.15 DA(H) 863' (300')	RNP 0.30 DA(H) 1082' (519')
	HIALS out	
A		
B		
C	R50 or V1	V1 1/4
D		V1 1/2

CYYZ/YYZ

LESTER B PEARSON INTL

JEPPESSEN
28 APR 23 **(12-21)**

TORONTO, ONT

RNAV (RNP) Y Rwy 23

D-ATIS	LONDON Radio	TORONTO Arrival			TORONTO Tower		Ground		
120.825 133.1	123.275	132.8	124.475	125.4	118.35	118.7	121.9	121.65 119.1	

BRIEFING STRIP™

RNAV	Final Apch Crs 237°	Minimum Alt DANOS 2700' (2143')	RNP 0.15 DA(H) 854' (297')	Apt Elev 569' Rwy 557'	 3100 MSA RW23
MISSED APCH: Climb to 1100' heading 237°. Then climbing RIGHT turn to 3000' direct to IKDOT.					
Alt Set: INCHES Trans level: FL180 Trans alt: 18000' 1. AUTHORIZATION REQUIRED. 2. SAFE ALTITUDE WITHIN 100 NM 4900'. 3. Simultaneous approach authorized with Rwy 24L or 24R. 4. See Attention All Users - - Established on RNP AR User Instructions (12-0). 5. For uncompensated Baro-VNAV systems, procedure not authorized below -23°C (-9°F) and above 45°C (113°F).					

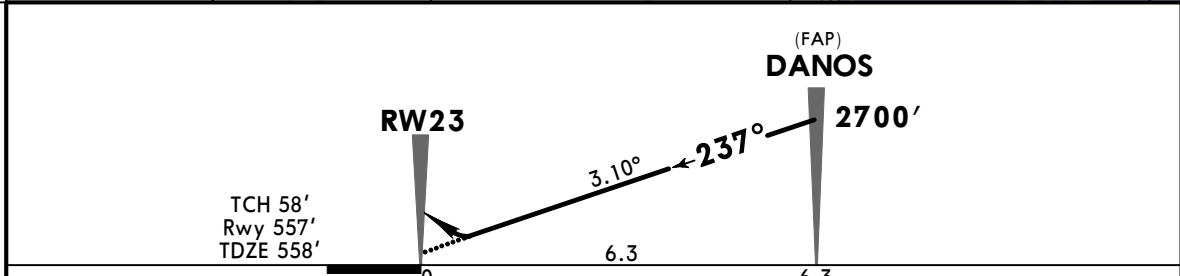
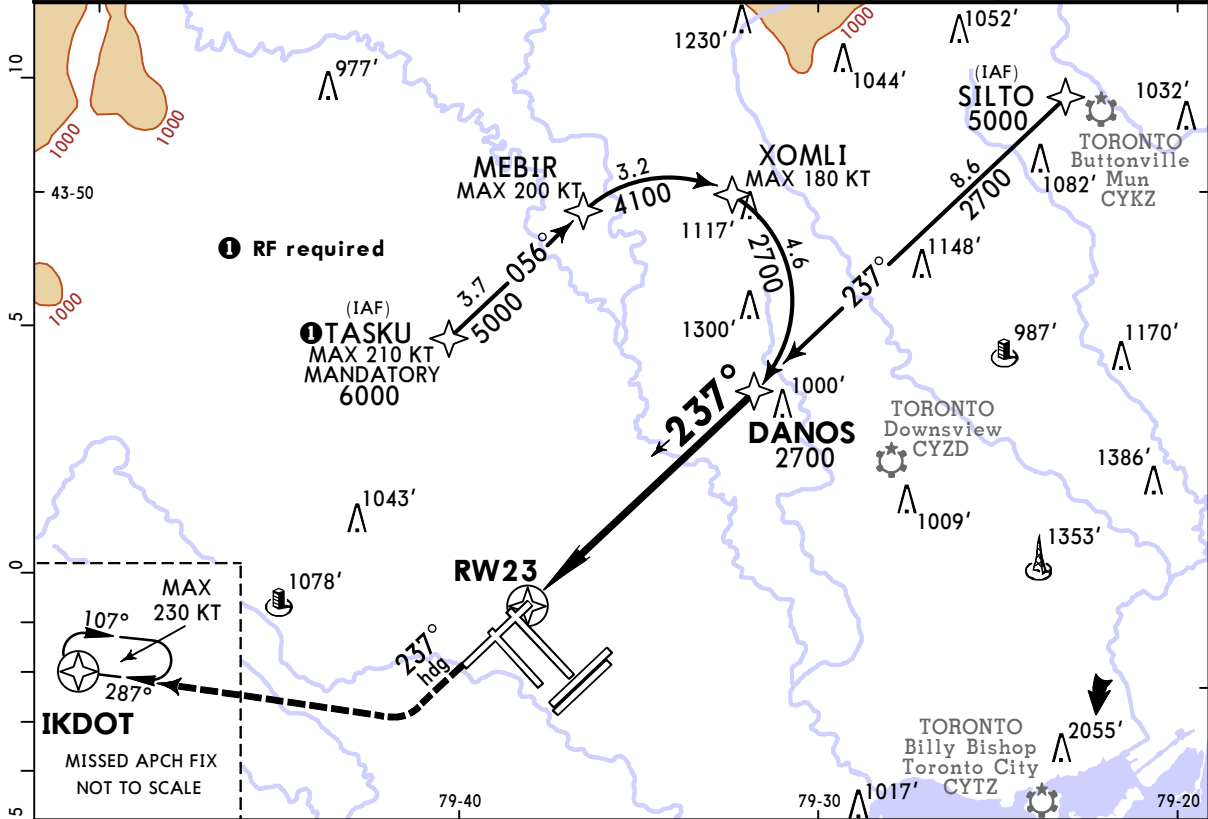

Gnd speed-Kts	70	90	100	120	140	160	SSALR PAPI 1100' ↑ 237° hdg	
Glide Path Angle	3.10°	384	494	548	658	768		878

State	STRAIGHT-IN LANDING		
	RNP 0.15		RNP 0.30
	DA(H) 854' (297')		DA(H) 997' (440')
	HIALS out		HIALS out
A			
B			
C	R50 or V1	R50 or V1	V1 1/2
D			

CHANGES: Airport name, new AOM concept.

Chart changes since cycle 08-2023

ADD = added chart, REV = revised chart, DEL = deleted chart.

ACT	PROCEDURE IDENT	INDEX	REV DATE	EFF DATE
VANCOUVER, BC (VANCOUVER INTL - CYVR)				
TORONTO, ON (LESTER B PEARSON INTL - CYYZ)				
REV	AIRPORT BRIEFING	10-1P	28 Apr 2023	
REV	AIRPORT BRIEFING (CONTD 1...	10-1P1	28 Apr 2023	
REV	BOXUM 6 ARR (RWYS 05 & 06...	10-2	28 Apr 2023	
REV	BOXUM 6 ARR (RWYS 15L/R)	10-2A	28 Apr 2023	
REV	BOXUM 6 ARR (RWYS 23 & 24...	10-2A1	28 Apr 2023	
REV	BOXUM 6 ARR (RWYS 33L/R)	10-2A2	28 Apr 2023	
REV	DUVOS 4 ARR (RWYS 05 & 06...	10-2B	28 Apr 2023	
REV	DUVOS 4 ARR (RWYS 15L/R)	10-2B1	28 Apr 2023	
REV	DUVOS 4 ARR (RWYS 23 & 24...	10-2B2	28 Apr 2023	
REV	DUVOS 4 ARR (RWY 33L)	10-2B3	28 Apr 2023	
REV	DUVOS 4 ARR (RWY 33R)	10-2B4	28 Apr 2023	
REV	IMEBA 9 ARR (RWYS 05 & 06...	10-2C	28 Apr 2023	
REV	IMEBA 9 ARR (RWYS 15L/R)	10-2C1	28 Apr 2023	
REV	IMEBA 9 ARR (RWYS 23 & 24...	10-2C2	28 Apr 2023	
REV	IMEBA 9 ARR (RWYS 33L/R)	10-2C3	28 Apr 2023	
REV	LINNG 3 ARR (RWYS 05 & 06...	10-2D	28 Apr 2023	
REV	LINNG 3 ARR (RWYS 15L/R)	10-2D1	28 Apr 2023	
REV	LINNG 3 ARR (RWYS 23 & 24...	10-2D2	28 Apr 2023	
REV	LINNG 3 ARR (RWYS 33L/R)	10-2D3	28 Apr 2023	
REV	NAKBO 5 ARR (RWYS 05 & 06...	10-2E	28 Apr 2023	
REV	NAKBO 5 ARR (RWYS 15L/R &...	10-2E1	28 Apr 2023	
REV	NAKBO 5 ARR (RWYS 23 & 24...	10-2E2	28 Apr 2023	
REV	NUBER 5 ARR (RWYS 05 & 06...	10-2E3	28 Apr 2023	
REV	NUBER 5 ARR (RWYS 15L/R &...	10-2E4	28 Apr 2023	
REV	NUBER 5 ARR (RWYS 23 & 24...	10-2E5	28 Apr 2023	
REV	RAGID 5 ARR (RWYS 05 & 06...	10-2F	28 Apr 2023	
REV	RAGID 5 ARR (RWYS 15L/R)	10-2F1	28 Apr 2023	
REV	RAGID 5 ARR (RWYS 23 & 24...	10-2F2	28 Apr 2023	
REV	RAGID 5 ARR (RWYS 33L/R)	10-2F3	28 Apr 2023	
REV	UDNOX 5 ARR (RWYS 05 & 06...	10-2G	28 Apr 2023	
REV	UDNOX 5 ARR (RWYS 15L/R)	10-2G1	28 Apr 2023	
REV	UDNOX 5 ARR (RWYS 23 & 24...	10-2G2	28 Apr 2023	
REV	UDNOX 5 ARR (RWYS 33L/R)	10-2G3	28 Apr 2023	
REV	VERKO 1 ARR (RWYS 05 & 06...	10-2H	28 Apr 2023	
REV	VERKO 1 ARR (RWYS 15L/R)	10-2H1	28 Apr 2023	
REV	VERKO 1 ARR (RWYS 23 & 24...	10-2H2	28 Apr 2023	
REV	VERKO 1 ARR (RWYS 33L/R)	10-2H3	28 Apr 2023	
REV	VIBLI 6 ARR (RWYS 05 & 06...	10-2J	28 Apr 2023	
REV	VIBLI 6 ARR (RWYS 15L/R)	10-2J1	28 Apr 2023	
REV	VIBLI 6 ARR (RWYS 23 & 24...	10-2J2	28 Apr 2023	
REV	VIBLI 6 ARR (RWYS 33L/R)	10-2J3	28 Apr 2023	
REV	ANCOL 5 DEP (RWYS 05, 06L...	10-3	28 Apr 2023	
REV	ANCOL 5 DEP (RWYS 15L/R &...	10-3A	28 Apr 2023	
REV	ARROW 4 DEP	10-3A1	28 Apr 2023	
REV	AVSEP 7 DEP (RWYS 05, 06L...	10-3A2	28 Apr 2023	
REV	AVSEP 7 DEP (RWYS 15L/R &...	10-3A3	28 Apr 2023	
REV	BETES 3 DEP (RWYS 05, 06L...	10-3B	28 Apr 2023	

REV BETES 3 DEP (RWYS 15L/R &...	10-3B1	28 Apr 2023
REV BOMET 8 DEP (RWYS 05, 06L...	10-3B2	28 Apr 2023
REV BOMET 8 DEP (RWYS 15L/R &...	10-3B3	28 Apr 2023
REV DEDKI 5 DEP (RWYS 05, 06L...	10-3C	28 Apr 2023
REV DEDKI 5 DEP (RWYS 15L/R &...	10-3C1	28 Apr 2023
REV DUSOM 3 DEP (RWYS 05, 06L...	10-3C2	28 Apr 2023
REV DUSOM 3 DEP (RWYS 15L/R &...	10-3C3	28 Apr 2023
REV EBKIN 4 DEP (RWYS 05, 06L...	10-3D	28 Apr 2023
REV EBKIN 4 DEP (RWYS 15L/R &...	10-3D1	28 Apr 2023
REV GOPUP 4 DEP (RWYS 05, 06L...	10-3D2	28 Apr 2023
REV GOPUP 4 DEP (RWYS 15L/R &...	10-3D3	28 Apr 2023
REV IKLEN 3 DEP (RWYS 05, 06L...	10-3E	28 Apr 2023
REV IKLEN 3 DEP (RWYS 15L/R &...	10-3E1	28 Apr 2023
REV KEPTA 3 DEP (RWYS 05, 06L...	10-3E2	28 Apr 2023
REV KEPTA 3 DEP (RWYS 15L/R &...	10-3E3	28 Apr 2023
REV KISEP 4 DEP (RWYS 05, 06L...	10-3E4	28 Apr 2023
REV KISEP 4 DEP (RWYS 15L/R &...	10-3E5	28 Apr 2023
REV LAKES 4 DEP (RWYS 05, 06L...	10-3F	28 Apr 2023
REV LAKES 4 DEP (RWYS 15L/R &...	10-3F1	28 Apr 2023
REV MATES 6 DEP (RWYS 05, 06L...	10-3G	28 Apr 2023
REV MATES 6 DEP (RWYS 15L/R &...	10-3G1	28 Apr 2023
REV MAVAN 3 DEP (RWYS 05, 06L...	10-3G2	28 Apr 2023
REV MAVAN 3 DEP (RWYS 15L/R &...	10-3G3	28 Apr 2023
REV MIXUT 7 DEP (RWYS 05, 06L...	10-3G4	28 Apr 2023
REV MIXUT 7 DEP (RWYS 15L/R &...	10-3G5	28 Apr 2023
REV NOSIK 4 DEP (RWYS 05, 06L...	10-3H	28 Apr 2023
REV NOSIK 4 DEP (RWYS 15L/R &...	10-3H1	28 Apr 2023
REV NUGOP 6 DEP (RWYS 05, 06L...	10-3H2	28 Apr 2023
REV NUGOP 6 DEP (RWYS 15L/R &...	10-3H3	28 Apr 2023
REV OAKVL 3 DEP (RWYS 05, 06L...	10-3H4	28 Apr 2023
REV OAKVL 3 DEP (RWYS 15L/R &...	10-3H5	28 Apr 2023
REV PEMBA 6 DEP (RWYS 05, 06L...	10-3J	28 Apr 2023
REV PEMBA 6 DEP (RWYS 15L/R &...	10-3J1	28 Apr 2023
REV PERLO 5 DEP (RWYS 05, 06L...	10-3J2	28 Apr 2023
REV PERLO 5 DEP (RWYS 15L/R &...	10-3J3	28 Apr 2023
REV RIGUS 5 DEP (RWYS 05, 06L...	10-3K	28 Apr 2023
REV RIGUS 5 DEP (RWYS 15L/R &...	10-3K1	28 Apr 2023
REV SEDOG 6 DEP (RWYS 05, 06L...	10-3L	28 Apr 2023
REV SEDOG 6 DEP (RWYS 15L/R &...	10-3M	28 Apr 2023
REV TEVAD 3 DEP (RWYS 05, 06L...	10-3N	28 Apr 2023
REV TEVAD 3 DEP (RWYS 15L/R &...	10-3P	28 Apr 2023
REV TORONTO 4 DEP	10-3Q	28 Apr 2023
REV TULEK 4 DEP (RWYS 05, 06L...	10-3Q1	28 Apr 2023
REV TULEK 4 DEP (RWYS 15L/R &...	10-3Q2	28 Apr 2023
REV URSAL 4 DEP (RWYS 05, 06L...	10-3Q3	28 Apr 2023
REV URSAL 4 DEP (RWYS 15L/R &...	10-3Q4	28 Apr 2023
REV VERDO 7 DEP (RWYS 05, 06L...	10-3S	28 Apr 2023
REV VERDO 7 DEP (RWYS 15L/R &...	10-3T	28 Apr 2023
REV NOISE ABATEMENT	10-4	28 Apr 2023
REV NOISE ABATEMENT CONTD 1	10-4A	28 Apr 2023
REV NOISE ABATEMENT CONTD 2	10-4B	28 Apr 2023
REV CONSTRUCTION ACTIVITIES (...)	10-8	28 Apr 2023
REV CONSTRUCTION ACTIVITIES (...)	10-8A	28 Apr 2023
REV CONSTRUCTION ACTIVITIES (...)	10-8B	28 Apr 2023
REV CONSTRUCTION ACTIVITIES (...)	10-8C	28 Apr 2023
REV CONSTRUCTION ACTIVITIES (...)	10-8D	28 Apr 2023

REV CONSTRUCTION ACTIVITIES (...)	10-8E	28 Apr 2023
REV CONSTRUCTION ACTIVITIES (...)	10-8F	28 Apr 2023
REV CONSTRUCTION ACTIVITIES (...)	10-8G	28 Apr 2023
REV CONSTRUCTION ACTIVITIES (...)	10-8H	28 Apr 2023
REV AIRPORT, AIRPORT INFO	10-9	28 Apr 2023
REV AIRPORT INFO (CONTD), TAK...	10-9A	28 Apr 2023
REV APRON PROCS, PARKING GATE...	10-9B	28 Apr 2023
REV TAXILANE LIMITATIONS	10-9B1	28 Apr 2023
REV TAXILANE LIMITATIONS CONT...	10-9B2	28 Apr 2023
REV PARKING AREAS (INFIELD)	10-9C	28 Apr 2023
REV COMMUTER PARKING AREAS	10-9D	28 Apr 2023
REV PARKING POSITION COORDS	10-9D1	28 Apr 2023
REV LOW VIS TAXI CHART, LAND ...	10-9E	28 Apr 2023
REV LOW VIS TAXI CHART, LAND ...	10-9F	28 Apr 2023
REV LOW VIS TAXI CHART, LAND ...	10-9F1	28 Apr 2023
REV LOW VIS PROCS	10-9G	28 Apr 2023
REV DE-ICING	10-9H	28 Apr 2023
REV DE-ICING CONTD 1	10-9J	28 Apr 2023
REV DE-ICING CONTD 2	10-9K	28 Apr 2023
REV ENGINE FAN BLADE ICE SHED...	10-9L	28 Apr 2023
REV ENGINE FAN BLADE ICE SHED...	10-9M	28 Apr 2023
REV ILS RWY 05	11-1	28 Apr 2023
REV ILS RWY 33R	11-10	28 Apr 2023
REV ILS CAT II OR III RWY 05	11-1A	28 Apr 2023
REV ILS RWY 06L	11-2	28 Apr 2023
REV ILS CAT II OR III RWY 06L	11-2A	28 Apr 2023
REV ILS RWY 06R	11-3	28 Apr 2023
REV ILS RWY 15L	11-4	28 Apr 2023
REV ILS RWY 15R	11-5	28 Apr 2023
REV ILS RWY 23	11-6	28 Apr 2023
REV ILS RWY 24L	11-7	28 Apr 2023
REV ILS RWY 24R	11-8	28 Apr 2023
REV ILS RWY 33L	11-9	28 Apr 2023
REV ESTABLISHED ON RNP AR USE...	12-0	28 Apr 2023
REV RNAV (GNSS) Z RWY 05	12-1	28 Apr 2023
REV RNAV (GNSS) X RWY 23	12-10	28 Apr 2023
REV RNAV (GNSS) Z RWY 24L	12-11	28 Apr 2023
REV RNAV (GNSS) X RWY 24L	12-12	28 Apr 2023
REV RNAV (GNSS) Z RWY 24R	12-13	28 Apr 2023
REV RNAV (GNSS) X RWY 24R	12-14	28 Apr 2023
REV RNAV (GNSS) Z RWY 33L	12-15	28 Apr 2023
REV RNAV (GNSS) Z RWY 33R	12-16	28 Apr 2023
REV RNAV (GNSS) X RWY 05	12-2	28 Apr 2023
REV RNAV (RNP) Y RWY 05	12-20	28 Apr 2023
REV RNAV (RNP) Y RWY 23	12-21	28 Apr 2023
REV RNAV (GNSS) Z RWY 06L	12-3	28 Apr 2023
REV RNAV (GNSS) X RWY 06L	12-4	28 Apr 2023
REV RNAV (GNSS) Z RWY 06R	12-5	28 Apr 2023
REV RNAV (GNSS) X RWY 06R	12-6	28 Apr 2023
REV RNAV (GNSS) Z RWY 15L	12-7	28 Apr 2023
REV RNAV (GNSS) Z RWY 15R	12-8	28 Apr 2023
REV RNAV (GNSS) Z RWY 23	12-9	28 Apr 2023

TERMINAL CHART CHANGE NOTICES

No Chart Change Notices for Airport CYVR

No Chart Change Notices for Airport CYYZ

Chart Change Notices for Country CAN

Type: Gen Tmnl

Effectivity: Permanent

Begin Date: Immediately

End Date: No end date

At locations with approach charts depicting the Plan View Ball Flag Note: "Minimum VDA intercept [altitude]" or "Recommended VDA intercept [altitude]", it should read "VDA intercept based on [altitude]".

Communication Information For CZEG ACC No communication information available

Communication Information For CZEG FIR CPDLC Service: CPDLC SERVICES ARE AVAILABLE WITH

LOGON ADDRESS OF CZEG IN EDMONTON FIR

SATCOM Service: SATCOM VOICE DIRECT DIAL IS 1-780-890-2775

INMARSAT Service: INMARSAT SECURITY NUMBER IS 431601 INMARSAT SECURITY NUMBER FOR ARCTIC RADIO IS 431610

Callsign:	Frequency	Radar	ServiceIndicators
-----------	-----------	-------	-------------------

Type: ACC:

EDMONTON CENTRE:	123.7 MHz		
EDMONTON CENTRE:	123.9 MHz		
EDMONTON CENTRE:	124.15 MHz		
EDMONTON CENTRE:	124.2 MHz		
EDMONTON CENTRE:	124.25 MHz		
EDMONTON CENTRE:	124.3 MHz		
EDMONTON CENTRE:	124.45 MHz		
EDMONTON CENTRE:	124.52 MHz		
EDMONTON CENTRE:	124.75 MHz		
EDMONTON CENTRE:	124.85 MHz		
EDMONTON CENTRE:	125.05 MHz		
EDMONTON CENTRE:	127.77 MHz		
EDMONTON CENTRE:	132.05 MHz		
EDMONTON CENTRE:	132.07 MHz		
EDMONTON CENTRE:	132.1 MHz		
EDMONTON CENTRE:	132.15 MHz		
EDMONTON CENTRE:	132.22 MHz		
EDMONTON CENTRE:	132.25 MHz		
EDMONTON CENTRE:	132.4 MHz		
EDMONTON CENTRE:	132.5 MHz		
EDMONTON CENTRE:	132.55 MHz		
EDMONTON CENTRE:	132.6 MHz		
EDMONTON CENTRE:	132.65 MHz		
EDMONTON CENTRE:	132.67 MHz		
EDMONTON CENTRE:	132.7 MHz		
EDMONTON CENTRE:	132.75 MHz		
EDMONTON CENTRE:	132.77 MHz	(R)	
EDMONTON CENTRE:	132.8 MHz	(R)	
EDMONTON CENTRE:	132.85 MHz		
EDMONTON CENTRE:	132.87 MHz		
EDMONTON CENTRE:	132.9 MHz		
EDMONTON CENTRE:	133.0 MHz		
EDMONTON CENTRE:	133.07 MHz		
EDMONTON CENTRE:	133.17 MHz		
EDMONTON CENTRE:	133.2 MHz		
EDMONTON CENTRE:	133.32 MHz		
EDMONTON CENTRE:	133.37 MHz		
EDMONTON CENTRE:	133.4 MHz		
EDMONTON CENTRE:	133.45 MHz		
EDMONTON CENTRE:	133.5 MHz		
EDMONTON CENTRE:	133.52 MHz	(R)	
EDMONTON CENTRE:	133.6 MHz		
EDMONTON CENTRE:	133.7 MHz		
EDMONTON CENTRE:	133.72 MHz	(R)	
EDMONTON CENTRE:	133.75 MHz		
EDMONTON CENTRE:	133.82 MHz	(R)	
EDMONTON CENTRE:	133.85 MHz		
EDMONTON CENTRE:	133.95 MHz		
EDMONTON CENTRE:	134.0 MHz		
EDMONTON CENTRE:	134.02 MHz		
EDMONTON CENTRE:	134.05 MHz		
EDMONTON CENTRE:	134.15 MHz		
EDMONTON CENTRE:	134.3 MHz		
EDMONTON CENTRE:	134.35 MHz		
EDMONTON CENTRE:	134.4 MHz		
EDMONTON CENTRE:	134.42 MHz		

EDMONTON CENTRE:	134.45 MHz	
EDMONTON CENTRE:	134.47 MHz	
EDMONTON CENTRE:	134.5 MHz	
EDMONTON CENTRE:	134.65 MHz	
EDMONTON CENTRE:	134.67 MHz	
EDMONTON CENTRE:	134.7 MHz	
EDMONTON CENTRE:	134.8 MHz	
EDMONTON CENTRE:	134.82 MHz	
EDMONTON CENTRE:	134.85 MHz	
EDMONTON CENTRE:	134.9 MHz	(R)
EDMONTON CENTRE:	135.02 MHz	
EDMONTON CENTRE:	135.1 MHz	
EDMONTON CENTRE:	135.17 MHz	
EDMONTON CENTRE:	135.2 MHz	
EDMONTON CENTRE:	135.27 MHz	
EDMONTON CENTRE:	135.4 MHz	
EDMONTON CENTRE:	135.47 MHz	(R)
EDMONTON CENTRE:	135.5 MHz	
EDMONTON CENTRE:	135.6 MHz	
EDMONTON CENTRE:	135.7 MHz	
EDMONTON CENTRE:	135.75 MHz	
EDMONTON CENTRE:	135.8 MHz	

Communication Information For CZUL ACC No communication information available

Communication Information For CZVR FIR CPDLC Service: CPDLC SERVICES ARE AVAILABLE WITH LOGON ADDRESS OF CZVR IN VANCOUVER FIR. FLIGHTS ENTERING CANADIAN DOMESTIC AIRSPACE CPDLC AREA FROM A NON-CPDLC DATA LINK AREA SHOULD PERFORM A LOGON 45 TO 15 MINUTES PRIOR TO ENTERING AIRSPACE.
 SATCOM Service: SATCOM VOICE DIRECT DIAL IS 1-604-507-7875 CONTACT VANCOUVER CENTER ON THE NEAREST PERIPHERAL FREQUENCY AT THE TIME OF CROSSING FIR BOUNDARY. TRANSPONDER ADJUSTED TO REPLY ON MODE A-3 CODE 2000.
 INMARSAT Service: INMARSAT SECURITY NUMBER IS 431607

Callsign:	Frequency	Radar	ServiceIndicators
Type: ACC:			
VANCOUVER CENTRE:	123.87 MHz		
VANCOUVER CENTRE:	124.07 MHz		
VANCOUVER CENTRE:	128.4 MHz		
VANCOUVER CENTRE:	132.2 MHz		
VANCOUVER CENTRE:	132.35 MHz		
VANCOUVER CENTRE:	132.52 MHz		
VANCOUVER CENTRE:	132.9 MHz		
VANCOUVER CENTRE:	133.4 MHz		
VANCOUVER CENTRE:	133.5 MHz		
VANCOUVER CENTRE:	133.6 MHz		
VANCOUVER CENTRE:	133.67 MHz		
VANCOUVER CENTRE:	133.7 MHz		
VANCOUVER CENTRE:	133.77 MHz		
VANCOUVER CENTRE:	133.8 MHz		
VANCOUVER CENTRE:	134.0 MHz		
VANCOUVER CENTRE:	134.2 MHz		
VANCOUVER CENTRE:	134.4 MHz		
VANCOUVER CENTRE:	134.55 MHz		
VANCOUVER CENTRE:	134.6 MHz		
VANCOUVER CENTRE:	134.8 MHz		
VANCOUVER CENTRE:	135.0 MHz		
VANCOUVER CENTRE:	135.05 MHz		
VANCOUVER CENTRE:	135.5 MHz		

Communication Information For CZWG FIR CPDLC Service: CPDLC SERVICES ARE AVAILABLE WITH LOGON ADDRESS OF CZWG IN WINNIPEG FIR

SATCOM Service: SATCOM VOICE DIRECT DIAL IS 1-204-837-9481
 INMARSAT Service: INMARSAT SECURITY NUMBER IS 431608

Callsign:	Frequency	Radar	ServiceIndicators
-----------	-----------	-------	-------------------

Type: ACC:

WINNIPEG CENTRE:	118.0 MHz		
WINNIPEG CENTRE:	119.5 MHz		
WINNIPEG CENTRE:	119.7 MHz		
WINNIPEG CENTRE:	119.9 MHz		
WINNIPEG CENTRE:	120.1 MHz		
WINNIPEG CENTRE:	120.5 MHz		
WINNIPEG CENTRE:	121.0 MHz		
WINNIPEG CENTRE:	123.8 MHz		
WINNIPEG CENTRE:	124.0 MHz		
WINNIPEG CENTRE:	124.3 MHz		
WINNIPEG CENTRE:	124.47 MHz		
WINNIPEG CENTRE:	126.4 MHz		
WINNIPEG CENTRE:	132.12 MHz		
WINNIPEG CENTRE:	132.2 MHz		
WINNIPEG CENTRE:	132.25 MHz		
WINNIPEG CENTRE:	132.37 MHz		
WINNIPEG CENTRE:	132.52 MHz		
WINNIPEG CENTRE:	132.8 MHz		
WINNIPEG CENTRE:	132.82 MHz		
WINNIPEG CENTRE:	132.9 MHz		
WINNIPEG CENTRE:	133.1 MHz		
WINNIPEG CENTRE:	133.15 MHz		
WINNIPEG CENTRE:	133.25 MHz		
WINNIPEG CENTRE:	133.7 MHz		
WINNIPEG CENTRE:	133.77 MHz		
WINNIPEG CENTRE:	133.9 MHz		
WINNIPEG CENTRE:	133.95 MHz		
WINNIPEG CENTRE:	134.07 MHz		
WINNIPEG CENTRE:	134.17 MHz		
WINNIPEG CENTRE:	134.32 MHz		
WINNIPEG CENTRE:	134.4 MHz		
WINNIPEG CENTRE:	134.6 MHz		
WINNIPEG CENTRE:	134.65 MHz		
WINNIPEG CENTRE:	134.97 MHz		
WINNIPEG CENTRE:	135.05 MHz	(R)	
WINNIPEG CENTRE:	135.1 MHz		
WINNIPEG CENTRE:	135.15 MHz	(R)	
WINNIPEG CENTRE:	135.22 MHz		
WINNIPEG CENTRE:	135.32 MHz		
WINNIPEG CENTRE:	135.47 MHz	(R)	
WINNIPEG CENTRE:	135.62 MHz		

Type: Arrival:

WINNIPEG CENTRE:	133.9 MHz		
------------------	-----------	--	--

Type: Departure:

WINNIPEG CENTRE:	133.9 MHz		
------------------	-----------	--	--

Type: Radio:

WINNIPEG RADIO:	122.1 MHz		
WINNIPEG RADIO:	122.3 MHz		
WINNIPEG RADIO:	122.37 MHz		
WINNIPEG RADIO:	123.27 MHz		
WINNIPEG RADIO:	123.37 MHz		
WINNIPEG RADIO:	123.47 MHz		
WINNIPEG RADIO:	123.55 MHz		
WINNIPEG RADIO:	126.0 MHz		
WINNIPEG RADIO:	126.7 MHz		

Communication Information For CZZY FIR

CPDLC Service: CPDLC SERVICES ARE AVAILABLE WITH LOGON ADDRESS OF CZZY IN TORONTO FIR. FLIGHTS ENTERING CANADIAN DOMESTIC AIRSPACE CPDLC AREA FROM A NON-CPDLC DATA LINK AREA SHOULD PERFORM A LOGON 45 TO 15 MINUTES PRIOR TO ENTERING AIRSPACE

SATCOM Service: SATCOM VOICE DIRECT DIAL IS 1-905-676-4509

INMARSAT Service: INMARSAT SECURITY NUMBER IS 431606

Callsign:	Frequency	Radar	ServiceIndicators
Type: ACC:			
TORONTO CENTRE:	124.02 MHz		
TORONTO CENTRE:	124.07 MHz		
TORONTO CENTRE:	124.37 MHz		
TORONTO CENTRE:	124.67 MHz		
TORONTO CENTRE:	124.92 MHz		
TORONTO CENTRE:	125.77 MHz		
TORONTO CENTRE:	127.0 MHz		
TORONTO CENTRE:	127.25 MHz		
TORONTO CENTRE:	128.27 MHz		
TORONTO CENTRE:	128.3 MHz		
TORONTO CENTRE:	132.47 MHz		
TORONTO CENTRE:	132.57 MHz		
TORONTO CENTRE:	132.65 MHz		
TORONTO CENTRE:	132.8 MHz		
TORONTO CENTRE:	133.72 MHz		
TORONTO CENTRE:	134.25 MHz		
TORONTO CENTRE:	134.37 MHz		
TORONTO CENTRE:	134.42 MHz		
TORONTO CENTRE:	134.57 MHz		
TORONTO CENTRE:	134.92 MHz		
TORONTO CENTRE:	135.3 MHz		
TORONTO CENTRE:	135.4 MHz		
TORONTO CENTRE:	135.5 MHz		
TORONTO CENTRE:	135.62 MHz		
TORONTO CENTRE:	135.82 MHz		

Communication Information For KZAU FIR

Callsign:	Frequency	Radar	ServiceIndicators
Type: ACC:			
CHICAGO:	118.15 MHz	(R)	Discrete
CHICAGO:	118.55 MHz	(R)	
CHICAGO:	118.75 MHz	(R)	
CHICAGO:	119.22 MHz	(R)	
CHICAGO:	119.85 MHz	(R)	Discrete
CHICAGO:	120.12 MHz	(R)	
CHICAGO:	120.17 MHz	(R)	
CHICAGO:	120.35 MHz	(R)	Discrete
CHICAGO:	121.05 MHz	(R)	
CHICAGO:	121.35 MHz	(R)	
CHICAGO:	123.85 MHz	(R)	
CHICAGO:	124.55 MHz	(R)	
CHICAGO:	125.05 MHz	(R)	
CHICAGO:	125.1 MHz	(R)	Discrete
CHICAGO:	125.37 MHz	(R)	
CHICAGO:	127.05 MHz	(R)	
CHICAGO:	127.55 MHz	(R)	Discrete
CHICAGO:	127.6 MHz	(R)	
CHICAGO:	127.8 MHz	(R)	
CHICAGO:	128.4 MHz		
CHICAGO:	128.5 MHz	(R)	Discrete
CHICAGO:	128.65 MHz	(R)	
CHICAGO:	132.1 MHz	(R)	
CHICAGO:	132.3 MHz	(R)	

CHICAGO:	132.5 MHz	(R)	
CHICAGO:	132.8 MHz	(R)	Discrete
CHICAGO:	132.95 MHz	(R)	Discrete
CHICAGO:	133.2 MHz	(R)	
CHICAGO:	133.3 MHz	(R)	Discrete
CHICAGO:	133.35 MHz	(R)	
CHICAGO:	133.9 MHz	(R)	
CHICAGO:	133.95 MHz	(R)	
CHICAGO:	134.15 MHz	(R)	Discrete
CHICAGO:	134.2 MHz	(R)	
CHICAGO:	134.75 MHz	(R)	
CHICAGO:	134.82 MHz	(R)	
CHICAGO:	134.87 MHz	(R)	
CHICAGO:	135.45 MHz		
CHICAGO:	135.55 MHz	(R)	
CHICAGO:	135.6 MHz	(R)	Discrete
CHICAGO:	135.75 MHz	(R)	Discrete
CHICAGO:	135.9 MHz	(R)	

Communication Information For KZAU UIR

Callsign:	Frequency	Radar	ServiceIndicators
Type: ACC:			
CHICAGO:	118.22 MHz	(R)	
CHICAGO:	120.22 MHz	(R)	
CHICAGO:	120.37 MHz	(R)	
CHICAGO:	120.97 MHz	(R)	
CHICAGO:	125.22 MHz	(R)	
CHICAGO:	125.57 MHz	(R)	
CHICAGO:	125.97 MHz	(R)	
CHICAGO:	126.12 MHz	(R)	
CHICAGO:	126.32 MHz	(R)	
CHICAGO:	127.77 MHz	(R)	
CHICAGO:	132.22 MHz	(R)	
CHICAGO:	132.27 MHz	(R)	Discrete
CHICAGO:	132.5 MHz	(R)	
CHICAGO:	132.75 MHz	(R)	
CHICAGO:	133.35 MHz	(R)	
CHICAGO:	133.42 MHz	(R)	
CHICAGO:	134.32 MHz	(R)	
CHICAGO:	135.35 MHz	(R)	
CHICAGO:	135.4 MHz	(R)	
CHICAGO:	135.82 MHz	(R)	

Communication Information For KZLC FIR

Callsign:	Frequency	Radar	ServiceIndicators
Type: ACC:			
SALT LAKE CITY:	118.05 MHz	(R)	
SALT LAKE CITY:	118.97 MHz	(R)	
SALT LAKE CITY:	119.95 MHz	(R)	
SALT LAKE CITY:	124.35 MHz	(R)	
SALT LAKE CITY:	125.57 MHz	(R)	
SALT LAKE CITY:	126.85 MHz	(R)	
SALT LAKE CITY:	127.07 MHz	(R)	
SALT LAKE CITY:	127.7 MHz	(R)	
SALT LAKE CITY:	127.75 MHz	(R)	
SALT LAKE CITY:	127.82 MHz	(R)	
SALT LAKE CITY:	127.92 MHz	(R)	

SALT LAKE CITY:	128.05 MHz	(R)
SALT LAKE CITY:	128.35 MHz	(R)
SALT LAKE CITY:	128.55 MHz	(R)
SALT LAKE CITY:	132.25 MHz	(R)
SALT LAKE CITY:	132.4 MHz	(R)
SALT LAKE CITY:	133.25 MHz	(R)
SALT LAKE CITY:	133.4 MHz	(R)
SALT LAKE CITY:	133.45 MHz	(R)
SALT LAKE CITY:	133.6 MHz	(R)
SALT LAKE CITY:	133.8 MHz	(R)
SALT LAKE CITY:	133.9 MHz	(R)
SALT LAKE CITY:	135.77 MHz	(R)

Communication Information For KZLC UIR

Callsign:	Frequency	Radar	ServiceIndicators
Type: ACC:			
SALT LAKE CITY:	119.75 MHz	(R)	
SALT LAKE CITY:	119.95 MHz	(R)	
SALT LAKE CITY:	120.27 MHz	(R)	
SALT LAKE CITY:	121.15 MHz	(R)	
SALT LAKE CITY:	124.35 MHz	(R)	
SALT LAKE CITY:	125.92 MHz	(R)	
SALT LAKE CITY:	126.85 MHz	(R)	
SALT LAKE CITY:	127.75 MHz	(R)	
SALT LAKE CITY:	127.82 MHz	(R)	
SALT LAKE CITY:	127.92 MHz	(R)	
SALT LAKE CITY:	128.35 MHz	(R)	
SALT LAKE CITY:	128.55 MHz	(R)	
SALT LAKE CITY:	128.72 MHz	(R)	
SALT LAKE CITY:	132.4 MHz	(R)	
SALT LAKE CITY:	132.42 MHz	(R)	
SALT LAKE CITY:	133.25 MHz	(R)	
SALT LAKE CITY:	133.45 MHz	(R)	Discrete
SALT LAKE CITY:	133.6 MHz	(R)	Discrete
SALT LAKE CITY:	134.52 MHz	(R)	
SALT LAKE CITY:	135.77 MHz	(R)	

Communication Information For KZMP FIR CPDLC Service: CPDLC SERVICES ARE AVAILABLE WITH LOGON ADDRESS OF KUSA IN MINNEAPOLIS FIR CPDLC.

Callsign:	Frequency	Radar	ServiceIndicators
Type: ACC:			
MINNEAPOLIS:	118.05 MHz	(R)	
MINNEAPOLIS:	118.85 MHz	(R)	
MINNEAPOLIS:	119.1 MHz	(R)	
MINNEAPOLIS:	119.4 MHz	(R)	
MINNEAPOLIS:	119.6 MHz	(R)	
MINNEAPOLIS:	120.6 MHz	(R)	
MINNEAPOLIS:	120.85 MHz	(R)	
MINNEAPOLIS:	120.9 MHz	(R)	
MINNEAPOLIS:	121.05 MHz	(R)	
MINNEAPOLIS:	121.25 MHz	(R)	
MINNEAPOLIS:	124.2 MHz	(R)	Discrete
MINNEAPOLIS:	124.25 MHz	(R)	
MINNEAPOLIS:	124.4 MHz	(R)	
MINNEAPOLIS:	125.02 MHz	(R)	
MINNEAPOLIS:	125.1 MHz	(R)	
MINNEAPOLIS:	125.3 MHz	(R)	
MINNEAPOLIS:	125.47 MHz	(R)	

MINNEAPOLIS:	125.5 MHz	(R)	
MINNEAPOLIS:	125.55 MHz	(R)	
MINNEAPOLIS:	125.65 MHz	(R)	
MINNEAPOLIS:	126.05 MHz	(R)	
MINNEAPOLIS:	126.1 MHz	(R)	
MINNEAPOLIS:	126.25 MHz	(R)	
MINNEAPOLIS:	126.4 MHz	(R)	
MINNEAPOLIS:	126.45 MHz	(R)	
MINNEAPOLIS:	127.1 MHz	(R)	
MINNEAPOLIS:	127.3 MHz	(R)	
MINNEAPOLIS:	127.35 MHz		Discrete
MINNEAPOLIS:	127.6 MHz	(R)	
MINNEAPOLIS:	127.65 MHz	(R)	
MINNEAPOLIS:	127.75 MHz	(R)	
MINNEAPOLIS:	127.9 MHz	(R)	
MINNEAPOLIS:	128.0 MHz	(R)	
MINNEAPOLIS:	128.5 MHz	(R)	
MINNEAPOLIS:	128.6 MHz	(R)	
MINNEAPOLIS:	128.75 MHz	(R)	
MINNEAPOLIS:	132.05 MHz	(R)	
MINNEAPOLIS:	132.35 MHz	(R)	
MINNEAPOLIS:	132.9 MHz	(R)	
MINNEAPOLIS:	133.55 MHz	(R)	
MINNEAPOLIS:	133.65 MHz	(R)	
MINNEAPOLIS:	134.0 MHz	(R)	
MINNEAPOLIS:	134.55 MHz	(R)	
MINNEAPOLIS:	134.6 MHz	(R)	
MINNEAPOLIS:	134.75 MHz	(R)	
MINNEAPOLIS:	134.85 MHz	(R)	
MINNEAPOLIS:	135.0 MHz	(R)	
MINNEAPOLIS:	135.25 MHz	(R)	

Communication Information For KZMP UIR CPDLC Service: CPDLC SERVICES ARE AVAILABLE
 WITH LOGON ADDRESS OF KUSA IN MINNEAPOLIS FIR CPDLC.

Callsign:	Frequency	Radar	ServiceIndicators
Type: ACC:			
MINNEAPOLIS:	118.82 MHz	(R)	
MINNEAPOLIS:	118.85 MHz	(R)	
MINNEAPOLIS:	119.52 MHz	(R)	
MINNEAPOLIS:	119.72 MHz	(R)	
MINNEAPOLIS:	119.87 MHz	(R)	
MINNEAPOLIS:	123.72 MHz	(R)	
MINNEAPOLIS:	123.97 MHz	(R)	
MINNEAPOLIS:	124.2 MHz	(R)	
MINNEAPOLIS:	124.87 MHz	(R)	
MINNEAPOLIS:	126.25 MHz	(R)	
MINNEAPOLIS:	127.35 MHz	(R)	
MINNEAPOLIS:	127.6 MHz	(R)	
MINNEAPOLIS:	128.42 MHz	(R)	
MINNEAPOLIS:	132.15 MHz	(R)	
MINNEAPOLIS:	132.42 MHz	(R)	
MINNEAPOLIS:	133.07 MHz	(R)	
MINNEAPOLIS:	133.4 MHz	(R)	
MINNEAPOLIS:	133.45 MHz	(R)	
MINNEAPOLIS:	133.75 MHz	(R)	
MINNEAPOLIS:	134.22 MHz	(R)	
MINNEAPOLIS:	134.25 MHz	(R)	
MINNEAPOLIS:	134.55 MHz	(R)	
MINNEAPOLIS:	135.1 MHz	(R)	
MINNEAPOLIS:	135.7 MHz	(R)	
MINNEAPOLIS:	135.77 MHz	(R)	

Communication Information For KZOB ARTCC No communication information available

Communication Information For KZOB FIR

Callsign:	Frequency	Radar	ServiceIndicators
Type: ACC:			
CLEVELAND:	120.45 MHz	(R)	
CLEVELAND:	120.6 MHz	(R)	
CLEVELAND:	120.77 MHz	(R)	
CLEVELAND:	121.2 MHz	(R)	
CLEVELAND:	124.32 MHz	(R)	
CLEVELAND:	124.4 MHz	(R)	
CLEVELAND:	125.2 MHz	(R)	
CLEVELAND:	126.72 MHz	(R)	
CLEVELAND:	126.75 MHz	(R)	
CLEVELAND:	126.95 MHz	(R)	
CLEVELAND:	127.07 MHz	(R)	
CLEVELAND:	127.47 MHz	(R)	
CLEVELAND:	127.7 MHz	(R)	
CLEVELAND:	127.9 MHz	(R)	
CLEVELAND:	128.45 MHz	(R)	
CLEVELAND:	128.62 MHz	(R)	
CLEVELAND:	132.25 MHz	(R)	
CLEVELAND:	132.45 MHz	(R)	
CLEVELAND:	134.47 MHz	(R)	
CLEVELAND:	134.65 MHz	(R)	
CLEVELAND:	134.9 MHz	(R)	
CLEVELAND:	135.1 MHz	(R)	

Communication Information For KZOB UIR

Callsign:	Frequency	Radar	ServiceIndicators
Type: ACC:			
CLEVELAND:	118.62 MHz	(R)	
CLEVELAND:	119.32 MHz	(R)	
CLEVELAND:	119.37 MHz	(R)	
CLEVELAND:	119.72 MHz	(R)	
CLEVELAND:	119.87 MHz	(R)	
CLEVELAND:	120.07 MHz	(R)	
CLEVELAND:	120.62 MHz	(R)	
CLEVELAND:	121.07 MHz	(R)	
CLEVELAND:	125.42 MHz	(R)	
CLEVELAND:	125.87 MHz	(R)	
CLEVELAND:	126.52 MHz	(R)	
CLEVELAND:	127.67 MHz	(R)	
CLEVELAND:	128.02 MHz	(R)	
CLEVELAND:	132.12 MHz	(R)	
CLEVELAND:	132.92 MHz	(R)	
CLEVELAND:	133.07 MHz	(R)	
CLEVELAND:	133.37 MHz	(R)	
CLEVELAND:	133.52 MHz	(R)	
CLEVELAND:	133.87 MHz	(R)	
CLEVELAND:	134.12 MHz	(R)	
CLEVELAND:	134.77 MHz	(R)	
CLEVELAND:	135.17 MHz	(R)	
CLEVELAND:	135.37 MHz	(R)	
CLEVELAND:	135.72 MHz	(R)	

Communication Information For KZSE FIR

Callsign:	Frequency	Radar	ServiceIndicators
Type: ACC:			
SEATTLE:	119.65 MHz	(R)	
SEATTLE:	120.3 MHz	(R)	
SEATTLE:	123.95 MHz	(R)	
SEATTLE:	124.2 MHz	(R)	
SEATTLE:	124.85 MHz	(R)	
SEATTLE:	125.1 MHz	(R)	
SEATTLE:	125.8 MHz	(R)	
SEATTLE:	126.1 MHz	(R)	
SEATTLE:	126.15 MHz	(R)	
SEATTLE:	126.6 MHz	(R)	
SEATTLE:	127.05 MHz	(R)	
SEATTLE:	127.55 MHz	(R)	
SEATTLE:	127.6 MHz	(R)	
SEATTLE:	128.15 MHz	(R)	
SEATTLE:	128.3 MHz	(R)	
SEATTLE:	132.6 MHz	(R)	
SEATTLE:	134.95 MHz	(R)	
SEATTLE:	306.3 MHz	(R)	MIL

Communication Information For KZSE UIR

Callsign:	Frequency	Radar	ServiceIndicators
Type: ACC:			
SEATTLE:	119.22 MHz	(R)	
SEATTLE:	120.3 MHz	(R)	
SEATTLE:	121.35 MHz	(R)	
SEATTLE:	124.75 MHz	(R)	
SEATTLE:	125.1 MHz	(R)	
SEATTLE:	126.6 MHz	(R)	
SEATTLE:	127.05 MHz	(R)	
SEATTLE:	128.3 MHz	(R)	
SEATTLE:	128.45 MHz	(R)	
SEATTLE:	132.07 MHz	(R)	
SEATTLE:	134.9 MHz	(R)	
SEATTLE:	134.95 MHz	(R)	
SEATTLE:	135.15 MHz	(R)	
SEATTLE:	135.35 MHz	(R)	
SEATTLE:	135.45 MHz	(R)	
SEATTLE:	360.7 MHz	(R)	MIL

Operational Notes

Page 1 Strip Charts

EDMONTON TNA Type: Class E Airspace

Notes: TRANSPONDER REQUIRED

TRANSPONDER REQUIRED

TRANSPONDER REQUIRED

TRANSPONDER REQUIRED

TRANSPONDER REQUIRED

FELTS Type: Class E Airspace

Notes: EXCLUDES THAT AIRSPACE WITHIN THE SPOKANE INTERNATIONAL AIRPORT, WA, CLASS C AIRSPACE AREA.

KIRBY LAKE TNA Type: Class E Airspace

Notes: TRANSPONDER REQUIRED

BOARDMAN E6 Type: Class E5 Airspace

Notes: EXCLUDING THE PORTION WITHIN RESTRICTED AREA R-5704 DURING ITS PUBLISHED HOURS OF DESIGNATION.

BOISE E6 Type: Class E5 Airspace

Notes: EXCLUDING FEDERAL AIRWAYS, BOISE AND MCCALL, ID, AND ONTARIO, OR, CLASS E AIRSPACE AREAS.

BURLEY MUN Type: Class E5 Airspace

Notes: EXCEPT THAT AIRSPACE WITHIN THE CONFINES OF FEDERAL AIRWAYS.

EXCEPT THAT AIRSPACE WITHIN THE CONFINES OF FEDERAL AIRWAYS.

EXCEPT THAT AIRSPACE WITHIN THE CONFINES OF FEDERAL AIRWAYS.

CASCADE RANGE E6 Type: Class E5 Airspace

Notes: EXCLUDING FEDERAL AIRWAYS, WENATCHEE, WA, ELLENSBURG, WA, AND YAKIMA, WA, CLASS E AIRSPACE AREAS.

COLVILLE E6 Type: Class E5 Airspace

Notes: THAT AIRSPACE BELOW 1,200 FEET AGL IS EXCLUDED.

DEER PARK Type: Class E5 Airspace

Notes: EXCLUDING THE SPOKANE, WA, CLASS E AIRSPACE AREA.

LA GRANDE/UNION CO Type: Class E5 Airspace

Notes: EXCLUDING THAT AIRSPACE WITHIN FEDERAL AIRWAYS.

LEXINGTON Type: Class E5 Airspace

Notes: EXCLUDING THAT AIRSPACE WITHIN FEDERAL AIRWAYS.

NEWPORT MUN Type: Class E5 Airspace

Notes: EXCLUDING THAT AIRSPACE WITHIN FEDERAL AIRWAYS.

OLYMPIC PENINSULA E6 Type: Class E5 Airspace

Notes: THAT AIRSPACE BELOW 1,200 FEET AGL IS EXCLUDED.

RAVALLI CO Type: Class E5 Airspace

Notes: EXCLUDING THAT AIRSPACE WITHIN FEDERAL AIRWAYS.

SANDPOINT E6 Type: Class E5 Airspace

Notes: EXCLUDING FEDERAL AIRWAYS AND THAT AIRSPACE BELOW 1200' AGL.

SEATTLE-TACOMA INTL Type: Class E5 Airspace

Notes: EXCLUDING THAT AIRSPACE WITHIN THE WENATCHEE PANGBORN MEMORIAL AIRPORT, WA, CLASS E AIRSPACE AREA.

TILLAMOOK Type: Class E5 Airspace

Notes: EXCLUDING THAT AIRSPACE WITHIN FEDERAL AIRWAYS; THE ASTORIA, OR; THE PORTLAND- HILLSBORO, OR; AND THE PORTLAND, OR, CLASS E AIRSPACE AREAS.

EXCLUDING THAT AIRSPACE WITHIN FEDERAL AIRWAYS; THE ASTORIA, OR; THE PORTLAND- HILLSBORO, OR; AND THE PORTLAND, OR, CLASS E AIRSPACE AREAS.

YELLOWSTONE Type: Class E5 Airspace

Notes: EXCLUDING THAT PORTION THAT OVERLIES V298 AND V343.

CHRISTINA LAKE Type: Control Zone (CTZ/CTR)

Notes: TRANSPONDER REQUIRED

KIRBY LAKE Type: Control Zone (CTZ/CTR)

Notes: TRANSPONDER REQUIRED

PRIMROSE Type: Control Zone (CTZ/CTR)

Notes: TRANSPONDER REQUIRED

CZEG Type: FIR

Notes: AIRSPACE-ZONES, AREAS, AND REGIONS 1. DOMESTIC CLEARANCE - NORTH ATLANTIC (NAT) WEST-BOUND TRAFFIC. A) PILOTS PROCEEDING WESTBOUND ACROSS THE NORTH ATLANTIC (NAT) AND ENTERING CDA WITHIN THE GANDER, MONCTON AND MONTREAL FIRS SHALL COMPLY WITH THE FOLLOWING PROCEDURES: I) FLIGHTS CLEARED BY ATC VIA THE FLIGHT PLANNED ROUTE PRIOR TO REACHING CDA WILL NOT BE ISSUED EN-ROUTE CLEARANCES UPON ENTERING DOMESTIC AIRSPACE, AND ARE TO FOLLOW THE FLIGHT PLANNED ROUTE AS CLEARED. DOMESTIC EN-ROUTE CLEARANCES WILL BE ISSUED: A) FOR FLIGHTS THAT HAVE BEEN REROUTED AND EXIT OCEANIC AIRSPACE AT OTHER THAN THE FLIGHT PLANNED EXIT FIX: B) AT A PILOT'S REQUEST FOR ANOTHER ROUTING OR C) IF A FLIGHT PLAN HAS NOT BEEN RECEIVED BY THE ACC. B) IF ENTERING CANADIAN DOMESTIC AIRSPACE WITHIN THE EDMONTON FLIGHT INFORMATION REGION (FIR) THE ONWARD DOMESTIC ROUTING WILL HAVE BEEN ESTABLISHED IN COORDINATION BETWEEN THE REYKJAVIK AND EDMONTON ACCS, AND ADDITIONAL DOMESTIC CLEARANCE IS NOT NORMALLY REQUIRED. HOWEVER, IF THERE HAS BEEN A CHANGE IN ROUTE FROM FILED FLIGHT PLAN, CLARIFICATION OF THE ONWARD ROUTING MAY BE OBTAINED FROM EDMONTON ACC ON REQUEST. CPDLC: CPDLC SERVICES ARE AVAILABLE WITH LOGON ADDRESS OF CZEG IN EDMONTON FIR CPDLC: INMARSAT: INMARSAT SECURITY NUMBER IS 431601 INMARSAT: SATCOM: SATCOM VOICE DIRECT DIAL IS 1-780-890-2775 SATCOM: INMARSAT: INMARSAT SECURITY NUMBER FOR ARCTIC RADIO IS 431610 INMARSAT:

CZVR Type: FIR

Notes: THE VANCOUVER FIR WEST OF TOFINO, CAPE SCOTT, PORT HARDY, AND SANDSPIT NDB IS UNCONTROLLED BELOW 6000' AGL. CPDLC: CPDLC SERVICES ARE AVAILABLE WITH LOGON ADDRESS OF CZVR IN VANCOUVER FIR. FLIGHTS ENTERING CANADIAN DOMESTIC AIRSPACE CPDLC AREA FROM A NON-CPDLC DATA LINK AREA SHOULD PERFORM A LOGON 45 TO 15 MINUTES PRIOR TO ENTERING AIRSPACE. CPDLC: INMARSAT: INMARSAT SECURITY NUMBER IS 431607 INMARSAT: SATCOM: SATCOM VOICE DIRECT DIAL IS 1-604-507-7875 SATCOM: CONTACT VANCOUVER CENTER ON THE NEAREST PERIPHERAL FREQUENCY AT THE TIME OF CROSSING FIR BOUNDARY. TRANSPONDER ADJUSTED TO REPLY ON MODE A-3 CODE 2000. SATCOM:

CZWG Type: FIR

Notes: CPDLC: CPDLC SERVICES ARE AVAILABLE WITH LOGON ADDRESS OF CZWG IN WINNIPEG FIR CPDLC: INMARSAT: INMARSAT SECURITY NUMBER IS 431608 INMARSAT: SATCOM: SATCOM VOICE DIRECT DIAL IS 1-204-837-9481 SATCOM:

KZAK Type: FIR

Notes: CPDLC: USE LOGON ADDRESS KZAK FOR ALL CPDLC COMMUNICATIONS IN THE OAKLAND OCEANIC FIR. WHEN MAKING HF VOICE CHECK-IN WITH SAN FRANCISCO RADIO UPON TRANSFERRING DATA LINK CONTACT TO SAN FRANCISCO, SFO RADIO REQUESTS YOU INCLUDE; POINT OF DEPARTURE, DESTINATION, A/C REGISTRATION AND SELCAL CODE. FOR AIRCRAFT DEPARTING FROM AIRPORTS ALONG THE WEST COAST OF NORTH AMERICA, GUAM AND HAWAII, OAKLAND OCEANIC CONTROL REQUIRES THAT DATA-LINK AIRCRAFT NOT LOGON TO OAKLAND OCEANIC (KZAK) UNTIL AFTER LEAVING 10,000' MSL. FOR AIRCRAFT ENTERING THE OAKLAND OCEANIC FIR FROM NON-CPDLC AIRSPACE: LOG ON TO CPDLC AT LEAST 15 BUT NOT MORE THAN 45 MINUTES PRIOR TO ENTERING. FOR AIRCRAFT ENTERING THE OAKLAND OCEANIC FIR FROM ADJACENT CPDLC AIRSPACE: IF KZAK IS THE ACTIVE CENTER CONTACT SAN FRANCISCO RADIO. IF KZAK IS NOT THE ACTIVE CENTER, TERMINATE THE CPDLC CONNECTION WITHIN 5 MINUTES AFTER THE BOUNDARY IS CROSSED, THEN LOG ON TO KZAK AND CONTACT SAN FRANCISCO RADIO. FOR AIRCRAFT OVER-FLYING HONOLULU CERAP: AIRCRAFT WILL RECEIVE AN END SERVICE MESSAGE THAT WILL RESULT IN TERMINATION OF CPDLC. AIRCRAFT SHALL RE-LOG ON TO CPDLC PRIOR TO REENTERING OAKLAND OCEANIC FIR. FOR AIRCRAFT ENTERING GUAM CERAP: CONTACT GUAM CERAP 250 MILES OUT ON 118.7, SQUAWK 2100. FOR AIRCRAFT OVER-FLYING GUAM CERAP: CPDLC CONNECTION WITH OAKLAND MAY BE TERMINATED WITHIN THE GUAM CERAP. IF THE CPDLC CONNECTION WITH KZAK IS NOT TERMINATED, DO NOT USE CPDLC FOR ATC UNTIL GUAM CERAP ADVISES YOU TO AGAIN CONTACT ENROUTE COMMUNICATIONS OR SAN FRANCISCO RADIO. IT MAY BE NECESSARY TO LOG BACK ON TO CPDLC WITH KZAK 10-15 MINUTES PRIOR TO EXITING GUAM CERAP IF THE CPDLC CONNECTION WAS TERMINATED. CPDLC: INMARSAT: INMARSAT SECURITY NUMBER FOR OAKLAND CENTER IS 436697 INMARSAT: INMARSAT: INMARSAT SECURITY NUMBER FOR SAN FRANCISCO RADIO IS 436625 INMARSAT: SATCOM: SATCOM VOICE DIRECT DIAL FOR OAKLAND CENTER IS 1-510-745-3415 SATCOM: PILOTS SHOULD MONITOR VHF EMERGENCY FREQUENCY 121.5 MHZ ON LONG OVERWATER ROUTES WHEN POSSIBLE. SEE VHF EMERGENCY FREQUENCY REQUIREMENT. POSITION REPORTS OVER OAKLAND OCEANIC OCA/FIR 120 W BOUNDARIES A. AIRCRAFT ENTERING THE OAKLAND OCA/FIR OVER 120 DEGREES WEST LONGITUDE WITHOUT A KZAK ADS-C CONNECTION ARE REQUESTED TO FORWARD BOUNDARY POSIT

113 Type: Special Use Airspace

Notes: THE RULES FOR CLASS G AIRSPACE APPLY WHEN THE AREA IS ACTIVE. WHEN NOT ACTIVE, THE RULES FOR THE APPLICABLE SURROUNDING AIRSPACE APPLY.

116 Type: Special Use Airspace

Notes: RULES FOR CLASS G AIRSPACE APPLY WHEN THE AREA IS ACTIVE. WHEN NOT ACTIVE, THE RULES FOR THE APPLICABLE SURROUNDING AIRSPACE APPLY.

117 Type: Special Use Airspace

Notes: RULES FOR CLASS G AIRSPACE APPLY WHEN AREA IS ACTIVE. WHEN NOT ACTIVE, THE RULES FOR THE APPLICABLE SURROUNDING AIRSPACE APPLY.

118 Type: Special Use Airspace

Notes: THE RULES FOR CLASS G AIRSPACE APPLY WHEN THE AREA IS ACTIVE. WHEN NOT ACTIVE, THE RULES FOR THE APPLICABLE SURROUNDING AIRSPACE APPLY.

184 Type: Special Use Airspace

Notes: THE RULES FOR CLASS G AIRSPACE APPLY WHEN THE AREA IS ACTIVE. WHEN NOT ACTIVE, THE RULES FOR THE APPLICABLE SURROUNDING AIRSPACE APPLY.

186 Type: Special Use Airspace

Notes: THE RULES FOR CLASS G AIRSPACE APPLY WHEN THE AREA IS ACTIVE. WHEN NOT ACTIVE, THE RULES FOR THE APPLICABLE SURROUNDING AIRSPACE APPLY.

187 Type: Special Use Airspace

Notes: THE RULES FOR CLASS G AIRSPACE APPLY WHEN THE AREA IS ACTIVE. WHEN NOT ACTIVE, THE RULES FOR THE APPLICABLE SURROUNDING AIRSPACE APPLY.

188 Type: Special Use Airspace

Notes: THE RULES FOR CLASS G AIRSPACE APPLY WHEN THE AREA IS ACTIVE. WHEN NOT ACTIVE, THE RULES FOR THE APPLICABLE SURROUNDING AIRSPACE APPLY.

203 Type: Special Use Airspace

Notes: VERTICAL LIMITS: GND - 17,000' MSL, OCSL HIGHER BY NOTAM.

232 Type: Special Use Airspace

Notes: OCSL GND - 3399' BY NOTAM.

305 Type: Special Use Airspace

Notes: EXCLUDING CY(R)-303

BOARDMAN Type: Special Use Airspace

Notes: EXCLUDING THAT AIRSPACE WITHIN R-5701 AND R-5706 WHEN ACTIVE.

BOARDMANL* Type: Special Use Airspace

Notes: EXCLUDING THAT AIRSPACE WITHIN R-5701 AND R-5706 WHEN ACTIVE.

IDAHOFALLS Type: Special Use Airspace

Notes: A CORRIDOR 2 MILES WIDE WITH NO ALTITUDE RESTRICTIONS EXISTS IN THE NORTHERN PORTION OF THIS BOUNDARY EXTENDING FROM THE INTERSECTION OF ID 33 AND ID 22 NEAR THE POINT OF THE MOUNTAIN AT LAT. 43°48'16"N., LONG. 112°50'55"W.; DUE EAST APPROXIMATELY 12 MILES TO A POINT APPROXIMATELY 1 MILE SOUTH OF A CIRCULAR BUTTE AT LAT. 43°47'40"N., LONG. 112°34'30"W.

JARBIDGE N Type: Special Use Airspace

Notes: EXCLUDING THAT AIRSPACE 1500 FEET AGL AND BELOW WITHIN A 3 NM RADIUS OF THE GRASMERE ARPT, ID CENTERED AT LAT 42-22-00N, LONG 115-53-03W.

N2561 Type: Special Use Airspace

Notes: Obtain Pearson Field weather & establish two-way radio CTC with CTAF 119.000 prior entering the SFRA.

OLYMPIC Type: Special Use Airspace

Notes: EXCLUDING THAT AIRSPACE BELOW 1,200 FEET AGL.

PWDR RV 1B Type: Special Use Airspace

Notes: EXCLUDING THE AIRSPACE 1500' AGL AND BELOW WITHIN A 3 NM RADIUS OF THE COLSTRIP AIRPORT, MT.

PWDR RV 1C Type: Special Use Airspace

Notes: EXCLUDING THE AIRSPACE WITHIN THE NORTHERN CHEYENNE INDIAN RESERVATION.

PWDR RV 1D Type: Special Use Airspace

Notes: EXCLUDING THE AIRSPACE WITHIN THE NORTHERN CHEYENNE INDIAN RESERVATION AND THE AIRSPACE 1500' AGL AND BELOW WITHIN A 3 NM RADIUS OF THE ST. LABRE MISSION AIRPORT, MT.

PWDR RV 2L Type: Special Use Airspace

Notes: EXCLUDING THE AIRSPACE 1500' AGL AND BELOW WITHIN A 3 NM RADIUS OF BROADUS AIRPORT, MT; LAIRD RANCH AIRPORT, MT; LANNING RANCH AIRPORT, MT; CAMP CROOK AIRPORT, SD; AND SKY RANCH AIRPORT, SD.

PWDR RV 3L Type: Special Use Airspace

Notes: EXCLUDING THE AIRSPACE 2000' AGL AND BELOW WITHIN A 3 NM RADIUS OF BAKER MUNICIPAL AIRPORT, MT, AND BOWMAN MUNICIPAL AIRPORT, ND.

RAINIER 1 Type: Special Use Airspace

Notes: EXCLUDES THE AIRSPACE OF R-6703A, B, C, D, E, F, H AND J, WHEN ACTIVE.

RAINIER 2 Type: Special Use Airspace

Notes: EXCLUDES THE AIRSPACE OF R-6703F, G, H AND I, WHEN ACTIVE.

JAC Type: VOR

Notes: MINIMUM TURNING ALTITUDE V330 E TO V520 W 16000'; V328 NW TO V465 SW 15100'; V465 NE TO V330 W OR V520 W 16000'; V520 E TO V330 W 14200'.

JAWBN Type: Waypoint

Notes: MINIMUM TURNING ALTITUDE V495 SE TO V4 W 8000'.

OLIBY Type: Waypoint

Notes: GEG R-052 UNUSABLE AT OLIBY FROM 12000-14000 FT.

Page 2 Strip Charts

CHICAGO Type: Class B Airspace

Notes: VFR: VFR TRAFFIC REQUESTING TRAFFIC ADVISORIES OR TO TRANSITION THE CLASS B AIRSPACE CONTACT CHICAGO APP/DEP VFR:

DUPAGE Type: Class D Airspace

Notes: EXCLUDING THAT AIRSPACE WITHIN THE CHICAGO, IL, CLASS B AIRSPACE AREA.

BELLE PLAINE MUN Type: Class E5 Airspace

Notes: EXCLUDING THAT PORTION WHICH OVERLIES THE CEDAR RAPIDS, IA, CLASS E AIRSPACE AREA.

BISMARCK MUN Type: Class E5 Airspace

Notes: EXCLUDING ALL FEDERAL AIRWAYS.

BRITTON MUN Type: Class E5 Airspace

Notes: EXCLUDING ALL FEDERAL AIRWAYS.

CASSELTON MILLER REGL Type: Class E5 Airspace

Notes: EXCLUDING THAT AIRSPACE WITHIN THE FARGO, ND, CLASS E AIRSPACE AREA.

FOSS Type: Class E5 Airspace

Notes: EXCLUDING ALL FEDERAL AIRWAYS.

GRAND MARAIS/COOK CO Type: Class E5 Airspace

Notes: EXCLUDING THAT AIRSPACE WHICH OVERLIES P-204.

HAWLEY MUN Type: Class E5 Airspace

Notes: EXCLUDING THAT PORTION WHICH OVERLIES THE FARGO, ND, CLASS E AIRSPACE AREA.

INTERNATIONAL FALLS E6 Type: Class E5 Airspace

Notes: EXCLUDING THAT AIRSPACE WITHIN FEDERAL AIRWAYS AND WITHIN CANADIAN AIRSPACE.

MERCER CO REGL Type: Class E5 Airspace

Notes: EXCLUDING ALL FEDERAL AIRWAYS.

MILLER MUN Type: Class E5 Airspace

Notes: EXCLUDING THE ABERDEEN, SD; THE PIERRE, SD; THE MITCHELL, SD; AND THE HURON, SD, 1,200-FOOT CLASS E AIRSPACE AREAS AND ALL FEDERAL AIRWAYS.

STANLEY MUN Type: Class E5 Airspace

Notes: EXCLUDING THAT AIRSPACE WITHIN THE TIOGA, ND, MINOT, ND, AND NEW TOWN, ND, CLASS E AIRSPACE AREAS, AND EXCLUDING ALL FEDERAL AIRWAYS.

WATERTOWN REGIONAL Type: Class E5 Airspace

Notes: EXCLUDING THAT AIRSPACE WITHIN ALL FEDERAL AIRWAYS.

WEST BEND MUN Type: Class E5 Airspace

Notes: EXCLUDING THAT AIRSPACE WITHIN THE HARTFORD, WI, CLASS E AIRSPACE AREA.

REGINA TNA Type: Control Area (Airport)

Notes: EXCLUDING THE MOOSE JAW, SK MTCA

CZEG Type: FIR

Notes: AIRSPACE-ZONES, AREAS, AND REGIONS 1. DOMESTIC CLEARANCE - NORTH ATLANTIC (NAT) WEST-BOUND TRAFFIC. A) PILOTS PROCEEDING WESTBOUND ACROSS THE NORTH ATLANTIC (NAT) AND ENTERING CDA WITHIN THE GANDER, MONCTON AND MONTREAL FIRS SHALL COMPLY WITH THE FOLLOWING PROCEDURES: I) FLIGHTS CLEARED BY ATC VIA THE FLIGHT PLANNED ROUTE PRIOR TO REACHING CDA WILL NOT BE ISSUED EN-ROUTE CLEARANCES UPON ENTERING DOMESTIC AIRSPACE, AND ARE TO FOLLOW THE FLIGHT PLANNED ROUTE AS CLEARED. DOMESTIC EN-ROUTE CLEARANCES WILL BE ISSUED: A) FOR FLIGHTS THAT HAVE BEEN REROUTED AND EXIT OCEANIC AIRSPACE AT OTHER THAN THE FLIGHT PLANNED EXIT FIX: B) AT A PILOT'S REQUEST FOR ANOTHER ROUTING OR C) IF A FLIGHT PLAN HAS NOT BEEN RECEIVED BY THE ACC. B) IF ENTERING CANADIAN DOMESTIC AIRSPACE WITHIN THE EDMONTON FLIGHT INFORMATION REGION (FIR) THE ONWARD DOMESTIC ROUTING WILL HAVE BEEN ESTABLISHED IN COORDINATION BETWEEN THE REYKJAVIK AND EDMONTON ACCS, AND ADDITIONAL DOMESTIC CLEARANCE IS NOT NORMALLY REQUIRED. HOWEVER, IF THERE HAS BEEN A CHANGE IN ROUTE FROM FILED FLIGHT PLAN, CLARIFICATION OF THE ONWARD ROUTING MAY BE OBTAINED FROM EDMONTON ACC ON REQUEST. CPDLC: CPDLC SERVICES ARE AVAILABLE WITH LOGON ADDRESS OF CZEG IN EDMONTON FIR CPDLC: INMARSAT: INMARSAT SECURITY NUMBER IS 431601 INMARSAT: SATCOM: SATCOM VOICE DIRECT DIAL IS 1-780-890-2775 SATCOM: INMARSAT: INMARSAT SECURITY NUMBER FOR ARCTIC RADIO IS 431610 INMARSAT:

CZWG Type: FIR

Notes: CPDLC: CPDLC SERVICES ARE AVAILABLE WITH LOGON ADDRESS OF CZWG IN WINNIPEG FIR CPDLC: INMARSAT: INMARSAT SECURITY NUMBER IS 431608 INMARSAT: SATCOM: SATCOM VOICE DIRECT DIAL IS 1-204-837-9481 SATCOM:

KZMP Type: FIR

Notes: CPDLC: CPDLC SERVICES ARE AVAILABLE WITH LOGON ADDRESS OF KUSA IN MINNEAPOLIS FIR CPDLC.

305 Type: Special Use Airspace

Notes: EXCLUDING CY(R)-303

5402 Type: Special Use Airspace

Notes: EXCLUDING THE AIRSPACE WITHIN R-5401 WHEN ACTIVE, AND R-5403A WHEN ACTIVE.

BEAVER Type: Special Use Airspace

Notes: EXCLUDING THE AIRSPACE BELOW 1500 AGL WITHIN 3 NM OF THE FOLLOWING PUBLIC USE AIRPORTS: BIG FALLS, BIGFORK, BOWSTRING, NORTHHOME, AND WASKISH.

DEVL LK E* Type: Special Use Airspace

Notes: EXCLUDING R-5401, R-5402, R-5403A, R-5403B, R-5403C, R-5403D, R-5403E, AND R-5403F WHEN ACTIVE.

ONTONAGON Type: Special Use Airspace

Notes: EXCLUDING THE AIRSPACE AT AND BELOW 1500 FEET AGL WITHIN A 3 NM RADIUS OF THE ONTONAGON COUNTY - SCHUSTER FIELD AIRPORT.

PWDR RV 1B Type: Special Use Airspace

Notes: EXCLUDING THE AIRSPACE 1500' AGL AND BELOW WITHIN A 3 NM RADIUS OF THE COLSTRIP AIRPORT, MT.

PWDR RV 1C Type: Special Use Airspace

Notes: EXCLUDING THE AIRSPACE WITHIN THE NORTHERN CHEYENNE INDIAN RESERVATION.

PWDR RV 1D Type: Special Use Airspace

Notes: EXCLUDING THE AIRSPACE WITHIN THE NORTHERN CHEYENNE INDIAN RESERVATION AND THE AIRSPACE 1500' AGL AND BELOW WITHIN A 3 NM RADIUS OF THE ST. LABRE MISSION AIRPORT, MT.

PWDR RV 2L Type: Special Use Airspace

Notes: EXCLUDING THE AIRSPACE 1500' AGL AND BELOW WITHIN A 3 NM RADIUS OF BROADUS AIRPORT, MT; LAIRD RANCH AIRPORT, MT; LANNING RANCH AIRPORT, MT; CAMP CROOK AIRPORT, SD; AND SKY RANCH AIRPORT, SD.

PWDR RV 3L Type: Special Use Airspace

Notes: EXCLUDING THE AIRSPACE 2000' AGL AND BELOW WITHIN A 3 NM RADIUS OF BAKER MUNICIPAL AIRPORT, MT, AND BOWMAN MUNICIPAL AIRPORT, ND.

VOLK WEST Type: Special Use Airspace

Notes: EXCLUDES R-6904A & B WHEN ACTIVATED

KZMP Type: UIR

Notes: CPDLC: CPDLC SERVICES ARE AVAILABLE WITH LOGON ADDRESS OF KUSA IN MINNEAPOLIS FIR CPDLC.

Page 3 Strip Charts

CHICAGO Type: Class B Airspace

Notes: VFR: VFR TRAFFIC REQUESTING TRAFFIC ADVISORIES OR TO TRANSITION THE CLASS B AIRSPACE CONTACT CHICAGO APP/DEP VFR:

DETROIT Type: Class B Airspace

Notes: VFR: HEAVY VFR TRAFFIC BELOW FLOOR OF CLASS B AIRSPACE VFR:

WASHINGTON TRI-AREA Type: Class B Airspace

Notes: EXCLUDES PROHIBITED AREA P-56 AND THE AIRSPACE CONTAINED IN RESTRICTED AREAS R-4001A, R-4001B AND R-4001C WHEN ACTIVE.

EXCLUDES PROHIBITED AREA P-56.

EXCLUDES PROHIBITED AREA P-56.

EXCLUDES RESTRICTED AREA R-4001B WHEN ACTIVE.

EXCLUDING THE AIRSPACE CONTAINED IN RESTRICTED AREAS R-4001A, R-4001B AND R-4001C WHEN ACTIVE.

BOLTON Type: Class D Airspace

Notes: EXCLUDING THAT AIRSPACE WITHIN THE PORT COLUMBUS INTERNATIONAL AIRPORT, OH CLASS C AIRSPACE AREA.

DAVISON AAF Type: Class D Airspace

Notes: SPECIAL NOTICE: PILOTS ARE REQUIRED TO CONTACT DAVISON ATC 124.275 FOR TRANSITION THRU CLASS D AIRSPACE

DUPAGE Type: Class D Airspace

Notes: EXCLUDING THAT AIRSPACE WITHIN THE CHICAGO, IL, CLASS B AIRSPACE AREA.

MARTIN STATE Type: Class D Airspace

Notes: EXCLUDING THAT AIRSPACE WITHIN RESTRICTED AREAS R-4001A AND R-4001B WHEN THEY ARE IN EFFECT.

MORRISTOWN MUNICIPAL Type: Class D Airspace

Notes: EXCLUDING THE PORTION THAT COINCIDES WITH THE NEW YORK, NY, CLASS B AIRSPACE AREA.

PATUXENT RIVER NAS Type: Class D Airspace

Notes: EXCLUDING THAT AIRSPACE WITHIN RESTRICTED AREAS R-4005 AND R-4007 WHEN ACTIVE.

ST LOUIS REGL Type: Class D Airspace

Notes: EXCLUDING THAT AIRSPACE WITHIN THE LAMBERT-ST. LOUIS INTERNATIONAL AIRPORT, MO, CLASS B AIRSPACE AREA.

AKRON FULTON INTL Type: Class E Airspace

Notes: EXCLUDING THAT AIRSPACE WITHIN THE AKRON-CANTON REGIONAL AIRPORT, OH, CLASS C AIRSPACE AREA.

ATLANTIC LOW OFFSHORE AIRSPACE Type: Class E Airspace

Notes: EXCLUDING FEDERAL AIRWAYS AND THE EAST COAST LOW OFFSHORE AIRSPACE.

CUYAHOGA CO Type: Class E Airspace

Notes: EXCLUDING THAT AIRSPACE WITHIN THE CLEVELAND, CUYAHOGA COUNTY AIRPORT, OH, CLASS D AIRSPACE AREA.

MARTIN STATE Type: Class E Airspace

Notes: EXCLUDING THAT AIRSPACE WITHIN RESTRICTED AREAS R-4001A AND R-4001B WHEN THEY ARE IN EFFECT.

EXCLUDING THAT AIRSPACE WITHIN RESTRICTED AREAS R-4001A AND R-4001B WHEN THEY ARE IN EFFECT.

PATUXENT RIVER NAS Type: Class E Airspace

Notes: EXCLUDING THAT AIRSPACE WITHIN RESTRICTED AREAS R-4005 AND R-4007 WHEN ACTIVE.

EXCLUDING THAT AIRSPACE WITHIN RESTRICTED AREAS R-4005 AND R-4007 WHEN ACTIVE.

EXCLUDING THAT AIRSPACE WITHIN RESTRICTED AREAS R-4005 AND R-4007 WHEN ACTIVE.

EXCLUDING THAT AIRSPACE WITHIN RESTRICTED AREAS R-4005 AND R-4007 WHEN ACTIVE.

SAULT STE MARIE Type: Class E Airspace

Notes: PILOTS OPERATING IN CANADIAN / U.S. CLASS (D) AIRSPACE ARE REQUIRED TO ESTABLISH AND MAINTAIN TWO-WAY COMMUNICATIONS AND OBTAIN ATC CLEARANCE FROM SAULT STE MARIE ATCT (SAULT TWR 118.8) PRIOR TO OPERATING IN THE CLASS (D) AIRSPACE. TRAFFIC ADVISORY SERVICE (118.8) IS AVAILABLE IN THE U.S. CLASS (E) SURFACE EXTENSION 0700-2000LT.

BROWN CO Type: Class E5 Airspace

Notes: EXCLUDES AIRSPACE WITHIN THE WEST UNION, OH CLASS E AIRSPACE AREA.

BURLINGTON INTL Type: Class E5 Airspace

Notes: EXCLUDING THAT AIRSPACE WITHIN THE PLATTSBURGH, NY, CLASS E AIRSPACE AREA.

CANANDAIGUA Type: Class E5 Airspace

Notes: EXCLUDING THAT PORTION THAT COINCIDES WITH THE PALMYRA, NY, AIRSPACE AREA.

CEDAR RIDGE Type: Class E5 Airspace

Notes: EXCLUDING THE AIRSPACE WITHIN THE KEOKUK, IA, AND FORT MADISON, IA, CLASS E AIRSPACE AREAS.

CLEARFIELD-LAWRENCE Type: Class E5 Airspace

Notes: EXCLUDING THE PORTION THAT COINCIDES WITH THE PHILIPSBURG, PA, CLASS E AIRSPACE AREA.

COOPERSTOWN-WESTVILLE Type: Class E5 Airspace

Notes: EXCLUDES ONEONTA, NY CLASS E AIRSPACE.

DANSVILLE MUN Type: Class E5 Airspace

Notes: EXCLUDING THE PORTION THAT COINCIDES WITH THE HORNELL, NY, 700 FOOT CLASS E AIRSPACE.

DISTRICT OF COLUMBIA Type: Class E5 Airspace

Notes: THE PORTION WITHIN P-56 IS EXCLUDED.

THE PORTION WITHIN P-56 IS EXCLUDED.

GRAND MARAIS/COOK CO Type: Class E5 Airspace

Notes: EXCLUDING THAT AIRSPACE WHICH OVERLIES P-204.

GRIMES Type: Class E5 Airspace

Notes: EXCLUDES THE AIRSPACE WITHIN THE DAYTONA, OH CLASS E AIRSPACE AREA.

HARBOR SPRINGS Type: Class E5 Airspace

Notes: EXCLUDING THAT AIRSPACE WITHIN V-78.

INDIANAPOLIS EXECUTIVE Type: Class E5 Airspace

Notes: EXCLUDES THAT AIRSPACE WITHIN THE INDIANAPOLIS, IN CLASS C AIRSPACE AREA.

INTERNATIONAL FALLS E6 Type: Class E5 Airspace

Notes: EXCLUDING THAT AIRSPACE WITHIN FEDERAL AIRWAYS AND WITHIN CANADIAN AIRSPACE.

KENNEDY INTL Type: Class E5 Airspace

Notes: EXCLUDING THE AIRSPACE THAT COINCIDES WITH THE WRIGHTSTOWN, NJ, PITTSTOWN, NJ, PHILADELPHIA, PA, POUGHKEEPSIE, NY, NEWBURGH, NY, AND DANBURY, CT CLASS E AIRSPACE AREAS.

MARYLAND Type: Class E5 Airspace

Notes: EXCLUDING THAT AIRSPACE WITHIN PROHIBITED AREA P-40.

NORFOLK Type: Class E5 Airspace

Notes: EXCLUDING THAT AIRSPACE THAT COINCIDES WITH W-50A AND R-6606 WHEN THEY ARE IN EFFECT.

PORT MEADVILLE Type: Class E5 Airspace

Notes: EXCLUDING THE PORTION THAT COINCIDES WITH THE GREENVILLE, PA, CLASS E AIRSPACE AREA.

RANTOUL NATL AVIATION CENTER-E Type: Class E5 Airspace

Notes: EXCLUDING THOSE PORTIONS WHICH OVERLIE THE CHAMPAIGN, IL, AND PAXTON, IL, CLASS E AIRSPACE AREAS.

SAULT STE MARIE Type: Class E5 Airspace

Notes: EXCLUDING THAT PORTION OF AIRSPACE OUTSIDE THE UNITED STATES.

SYRACUSE HANCOCK INTL Type: Class E5 Airspace

Notes: EXCLUDING THAT PORTION THAT COINCIDES WITH THE FULTON, NY, DURHAMVILLE, NY, AND SKANEATELES, NY, CLASS E AIRSPACE AREAS.

UPSHUR CO Type: Class E5 Airspace

Notes: EXCLUDING THAT PORTION THAT COINCIDES WITH THE CLARKSBURG, WV CLASS E AIRSPACE AREA.

WAYNESVILLE-ST. ROBERT REGL FO Type: Class E5 Airspace

Notes: EXCLUDING THAT AIRSPACE WITHIN THE R-4501 FORT LEONARD WOOD, MO, RESTRICTED AREAS DURING THE SPECIFIC TIMES THEY ARE IN EFFECT.

WEST BEND MUN Type: Class E5 Airspace

Notes: EXCLUDING THAT AIRSPACE WITHIN THE HARTFORD, WI, CLASS E AIRSPACE AREA.

ZANESVILLE MUN Type: Class E5 Airspace

Notes: EXCLUDING THAT AIRSPACE WITHIN THE CAMBRIDGE, OH CLASS E AIRSPACE AREA.

SAULT STE MARIE CAE Type: Control Area (Airport)

Notes: EXCLUDING THAT PORTION OF AIRSPACE OUTSIDE CANADA.

EXCLUDING THAT PORTION OF AIRSPACE OUTSIDE CANADA.

SAULT STE MARIE Type: Control Zone (CTZ/CTR)

Notes: EXCLUDING THAT PORTION OF AIRSPACE OUTSIDE CANADA.

PILOTS OPERATING IN CANADIAN / U.S. CLASS (D) AIRSPACE ARE REQUIRED TO ESTABLISH AND MAINTAIN TWO-WAY COMMUNICATIONS AND OBTAIN ATC CLEARANCE FROM SAULT STE MARIE ATCT (SAULT TWR 118.8) PRIOR TO OPERATING IN THE CLASS (D) AIRSPACE. TRAFFIC ADVISORY SERVICE (118.8) IS AVAILABLE IN THE U.S. CLASS (E) SURFACE EXTENSION 0700-2000LT.

WINDSOR Type: Control Zone (CTZ/CTR)

Notes: CLASS D CONTROL ZONE EXCLUDED BELOW 700' AGL OVER THE DETROIT RIVER AND LAKE ST CLAIR

CZEG Type: FIR

Notes: AIRSPACE-ZONES, AREAS, AND REGIONS 1. DOMESTIC CLEARANCE - NORTH ATLANTIC (NAT) WEST-BOUND TRAFFIC. A) PILOTS PROCEEDING WESTBOUND ACROSS THE NORTH ATLANTIC (NAT) AND ENTERING CDA WITHIN THE GANDER, MONCTON AND MONTREAL FIRS SHALL COMPLY WITH THE FOLLOWING PROCEDURES: 1) FLIGHTS CLEARED BY ATC VIA THE FLIGHT PLANNED ROUTE PRIOR TO REACHING CDA WILL NOT BE ISSUED EN-ROUTE CLEARANCES UPON ENTERING DOMESTIC AIRSPACE, AND ARE TO FOLLOW THE FLIGHT PLANNED ROUTE AS CLEARED. DOMESTIC EN-ROUTE CLEARANCES WILL BE ISSUED: A) FOR FLIGHTS THAT HAVE BEEN REROUTED AND EXIT OCEANIC AIRSPACE AT OTHER THAN THE FLIGHT PLANNED EXIT FIX: B) AT A PILOT'S REQUEST FOR ANOTHER ROUTING OR C) IF A FLIGHT PLAN HAS NOT BEEN RECEIVED BY THE ACC. B) IF ENTERING CANADIAN DOMESTIC AIRSPACE WITHIN THE EDMONTON FLIGHT INFORMATION REGION (FIR) THE ONWARD DOMESTIC ROUTING WILL HAVE BEEN ESTABLISHED IN COORDINATION BETWEEN THE REYKJAVIK AND EDMONTON ACCS, AND ADDITIONAL DOMESTIC CLEARANCE IS NOT NORMALLY REQUIRED. HOWEVER, IF THERE HAS BEEN A CHANGE IN ROUTE FROM FILED FLIGHT PLAN, CLARIFICATION OF THE ONWARD ROUTING MAY BE OBTAINED FROM EDMONTON ACC ON REQUEST. CPDLC: CPDLC SERVICES ARE AVAILABLE WITH LOGON ADDRESS OF CZEG IN EDMONTON FIR CPDLC: INMARSAT: INMARSAT SECURITY NUMBER IS 431601 INMARSAT: SATCOM: SATCOM VOICE DIRECT DIAL IS 1-780-890-2775 SATCOM: INMARSAT: INMARSAT SECURITY NUMBER FOR ARCTIC RADIO IS 431610 INMARSAT:

CZUL Type: FIR

Notes: CPDLC: CPDLC SERVICES ARE AVAILABLE WITH LOGON ADDRESS OF CZUL IN MONTREAL FIR. FLIGHTS ENTERING CANADIAN DOMESTIC AIRSPACE CPDLC AREA FROM A NON-CPDLC DATA LINK AREA SHOULD PERFORM A LOGON 45 TO 15 MINUTES PRIOR TO ENTERING AIRSPACE CPDLC: INMARSAT: INMARSAT SECURITY NUMBER IS 431605 INMARSAT: SATCOM: SATCOM VOICE DIRECT DIAL IS 1-514-636-3606 SATCOM:

CZWG Type: FIR

Notes: CPDLC: CPDLC SERVICES ARE AVAILABLE WITH LOGON ADDRESS OF CZWG IN WINNIPEG FIR CPDLC: INMARSAT: INMARSAT SECURITY NUMBER IS 431608 INMARSAT: SATCOM: SATCOM VOICE DIRECT DIAL IS 1-204-837-9481 SATCOM:

CZYZ Type: FIR

Notes: CPDLC: CPDLC SERVICES ARE AVAILABLE WITH LOGON ADDRESS OF CZYZ IN TORONTO FIR. FLIGHTS ENTERING CANADIAN DOMESTIC AIRSPACE CPDLC AREA FROM A NON-CPDLC DATA LINK AREA SHOULD PERFORM A LOGON 45 TO 15 MINUTES PRIOR TO ENTERING AIRSPACE CPDLC: INMARSAT: INMARSAT SECURITY NUMBER IS 431606 INMARSAT: SATCOM: SATCOM VOICE DIRECT DIAL IS 1-905-676-4509 SATCOM:

KZDC Type: FIR

Notes: CPDLC: CPDLC SERVICES ARE AVAILABLE WITH LOGON ADDRESS OF KUSA IN WASHINGTON FIR CPDLC.

KZID Type: FIR

Notes: CPDLC: CPDLC SERVICES ARE AVAILABLE WITH LOGON ADDRESS OF KUSA IN INDIANAPOLIS FIR CPDLC:

KZKC Type: FIR

Notes: CPDLC: CPDLC SERVICES ARE AVAILABLE WITH LOGON ADDRESS OF KUSA IN KANSAS CITY FIR CPDLC:

KZMP Type: FIR

Notes: CPDLC: CPDLC SERVICES ARE AVAILABLE WITH LOGON ADDRESS OF KUSA IN MINNEAPOLIS FIR CPDLC.

KZNY Type: FIR/UIR

Notes: AIRCRAFT INTENDING TO ENTER THE NEW YORK OCEANIC FIR FROM PIARCO FIR, OBTAIN OCEANIC CLEARANCE FROM PIARCO ACC ON 123.7 OR PIARCO RADIO AT LEAST 30 MINUTES PRIOR TO REACHING THE FIR BOUNDARY. CPDLC: CPDLC SERVICES ARE AVAILABLE WITH LOGON ADDRESS OF KZNY IN NEW YORK OCEANIC FIR CPDLC: INMARSAT: INMARSAT SECURITY NUMBER FOR NEW YORK OCEANIC EAST (NAT) IS 436695 INMARSAT: INMARSAT: INMARSAT SECURITY NUMBER FOR NEW YORK RADIO IS 436623 INMARSAT: INMARSAT: INMARSAT SECURITY NUMBER FOR NEW YORK OCEANIC WEST (WATRS) IS 436696 INMARSAT: SATCOM: SATCOM VOICE DIRECT DIAL FOR NEW YORK OCEANIC (NAT) IS 1-631-468-1496 SATCOM: SATCOM: SATCOM VOICE DIRECT DIAL FOR NEW YORK OCEANIC (WATRS) IS 1-631-468-1495 SATCOM:

NEW YORK OCEANIC CTA WEST Type: Oceanic Control Area (Non-Airport)

Notes: EXCLUDING THAT PORTION WITHIN THE AIRSPACE AT AND BELOW FL500 WITHIN 180 NM RADIUS OF THE BERMUDA VOR (NEW YORK RADAR AREA).

EAST RIVER SFRA Type: Special Rules Area

Notes: VFR: NEW YORK CLASS B HUDSON RIVER AND EAST RIVER EXCLUSIONS SPECIAL FLIGHT RULES AREA C.F.R. PART 93 SPECIAL AIR TRAFFIC RULES AND COMMUNICATION REQUIREMENTS ARE IN EFFECT FOR PERSONS OPERATING AIRCRAFT UNDER VFR, TO, FROM, OR IN THE VICINITY OF THE NEW YORK CLASS B AIRSPACE. THESE PROCEDURES ARE IN EFFECT WITHIN THE FOLLOWING BOUNDARIES: HUDSON RIVER AND EAST RIVER. COMMUNICATIONS:NO PERSON MAY OPERATE AN AIRCRAFT WITHIN THE AIRSPACE SPECIFIED ABOVE UNLESS THAT PERSON CONTINUOUSLY MONITORS AND COMMUNICATES, AS APPROPRIATE, ON THE DESIGNATED COMMON TRAFFIC ADVISORY FREQUENCY (CTAF). PILOTS SELF-ANNOUNCE AT THE FOLLOWING MANDATORY REPORTING POINTS: ALPINE TOWER, GWB, INTREPID, CLOCK, STATUE OF LIBERTY, VZ INCLUDE THE FOLLOWING INFORMATION: AIRCRAFT TYPE, CURRENT POSITION, DIRECTION OF FLIGHT AND ALTITUDE. AIRCRAFT OPERATION: THE FOLLOWING PRACTICES ARE MANDATORY IN BOTH THE HUDSON RIVER AND EAST RIVER EXCLUSIONS: MAINTAIN AN INDICATED AIRSPEED NOT TO EXCEED 140 KNOTS. ANTI-COLLISION LIGHTS AND AIRCRAFT POSITION/NAVIGATION LIGHTS SHALL BE ON. USE OF LANDING LIGHTS IS RECOMMENDED. PILOTS MUST HAVE A CURRENT NEW YORK TAC AND/OR NEW YORK HELICOPTER ROUTE CHART IN THE AIRCRAFT AND FAMILIARIZE THEMSELVES WITH THE INFORMATION CONTAINED THEREIN. THE FOLLOWING PRACTICES ARE MANDATORY IN THE EAST RIVER EXCLUSION: VFR FLIGHT OPERATIONS BY FIXED-WING AIRCRAFT (EXCLUDING SEAPLANE FIXED-WING AIRCRAFT LANDING OR DEPARTING THE NEW YORK SKYPORTS INC. SEAPLANE BASE) IN THE EAST RIVER CLASS B EXCLUSION (FROM THE SOUTHWESTERN TIP OF GOVERNORS ISLAND TO THE NORTHERN TIP OF ROOSEVELT ISLAND) ARE PROHIBITED UNLESS AUTHORIZED AND BEING CONTROLLED BY ATC. TO OBTAIN AUTHORIZATION, PILOTS MUST CONTACT LAGUARDIA AIRPORT TRAFFIC CONTROL TOWER PRIOR TO GOVENORS ISLAND. SELF ANNOUNCE ON THE APPROPRIATE CTAF. AIR TOUR HELICOPTERS MAY DESCEND FROM CLASS B AIRSPACE INTO THE SFRA IN THE VICINITY OF THE GEORGE WASHINGTON BRIDGE. VFR:

VFR: NEW YORK CLASS B HUDSON RIVER AND EAST RIVER EXCLUSIONS SPECIAL FLIGHT RULES AREA C.F.R. PART 93 SPECIAL AIR TRAFFIC RULES AND COMMUNICATION REQUIREMENTS ARE IN EFFECT FOR PERSONS OPERATING AIRCRAFT UNDER VFR, TO, FROM, OR IN THE VICINITY OF THE NEW YORK CLASS B AIRSPACE. THESE PROCEDURES ARE IN EFFECT WITHIN THE FOLLOWING BOUNDARIES: HUDSON RIVER AND EAST RIVER. COMMUNICATIONS:NO PERSON MAY OPERATE AN AIRCRAFT WITHIN THE AIRSPACE SPECIFIED ABOVE UNLESS THAT PERSON CONTINUOUSLY MONITORS AND COMMUNICATES, AS APPROPRIATE, ON THE DESIGNATED COMMON TRAFFIC ADVISORY FREQUENCY (CTAF). PILOTS SELF-ANNOUNCE AT THE FOLLOWING MANDATORY REPORTING POINTS: ALPINE TOWER, GWB, INTREPID, CLOCK, STATUE OF LIBERTY, VZ INCLUDE THE FOLLOWING INFORMATION: AIRCRAFT TYPE, CURRENT POSITION, DIRECTION OF FLIGHT AND ALTITUDE. AIRCRAFT OPERATION: THE FOLLOWING PRACTICES ARE MANDATORY IN BOTH THE HUDSON RIVER AND EAST RIVER EXCLUSIONS: MAINTAIN AN INDICATED AIRSPEED NOT TO EXCEED 140 KNOTS. ANTI-COLLISION LIGHTS AND AIRCRAFT POSITION/NAVIGATION LIGHTS SHALL BE ON. USE OF LANDING LIGHTS IS RECOMMENDED. PILOTS MUST HAVE A CURRENT NEW YORK TAC AND/OR NEW YORK HELICOPTER ROUTE CHART IN THE AIRCRAFT AND FAMILIARIZE THEMSELVES WITH THE INFORMATION CONTAINED THEREIN. THE FOLLOWING PRACTICES ARE MANDATORY IN THE EAST RIVER EXCLUSION: VFR FLIGHT OPERATIONS BY FIXED-WING AIRCRAFT (EXCLUDING SEAPLANE FIXED-WING AIRCRAFT LANDING OR DEPARTING THE NEW YORK SKYPORTS INC. SEAPLANE BASE) IN THE EAST RIVER CLASS B EXCLUSION (FROM THE SOUTHWESTERN TIP OF GOVERNORS ISLAND TO THE NORTHERN TIP OF ROOSEVELT ISLAND) ARE PROHIBITED UNLESS AUTHORIZED AND BEING CONTROLLED BY ATC. TO OBTAIN AUTHORIZATION, PILOTS MUST CONTACT LAGUARDIA AIRPORT TRAFFIC CONTROL TOWER PRIOR TO GOVERNORS ISLAND. SELF ANNOUNCE ON THE APPROPRIATE CTAF. AIR TOUR HELICOPTERS MAY DESCEND FROM CLASS B AIRSPACE INTO THE SFRA IN THE VICINITY OF THE GEORGE WASHINGTON BRIDGE. VFR:

HUDSON RIVER SFRA Type: Special Rules Area

Notes: VFR: NEW YORK CLASS B HUDSON RIVER AND EAST RIVER EXCLUSIONS SPECIAL FLIGHT RULES AREA C.F.R. PART 93 SPECIAL AIR TRAFFIC RULES AND COMMUNICATION REQUIREMENTS ARE IN EFFECT FOR PERSONS OPERATING AIRCRAFT UNDER VFR, TO, FROM, OR IN THE VICINITY OF THE NEW YORK CLASS B AIRSPACE. THESE PROCEDURES ARE IN EFFECT WITHIN THE FOLLOWING BOUNDARIES: HUDSON RIVER AND EAST RIVER. COMMUNICATIONS:NO PERSON MAY OPERATE AN AIRCRAFT WITHIN THE AIRSPACE SPECIFIED ABOVE UNLESS THAT PERSON CONTINUOUSLY MONITORS AND COMMUNICATES, AS APPROPRIATE, ON THE DESIGNATED COMMON TRAFFIC ADVISORY FREQUENCY (CTAF). PILOTS SELF-ANNOUNCE AT THE FOLLOWING MANDATORY REPORTING POINTS: ALPINE TOWER, GWB, INTREPID, CLOCK, STATUE OF LIBERTY, VZ INCLUDE THE FOLLOWING INFORMATION: AIRCRAFT TYPE, CURRENT POSITION, DIRECTION OF FLIGHT AND ALTITUDE. AIRCRAFT OPERATION: THE FOLLOWING PRACTICES ARE MANDATORY IN BOTH THE HUDSON RIVER AND EAST RIVER EXCLUSIONS: MAINTAIN AN INDICATED AIRSPEED NOT TO EXCEED 140 KNOTS. ANTI-COLLISION LIGHTS AND AIRCRAFT POSITION/NAVIGATION LIGHTS SHALL BE ON. USE OF LANDING LIGHTS IS RECOMMENDED. PILOTS MUST HAVE A CURRENT NEW YORK TAC AND/OR NEW YORK HELICOPTER ROUTE CHART IN THE AIRCRAFT AND FAMILIARIZE THEMSELVES WITH THE INFORMATION CONTAINED THEREIN. THE FOLLOWING PRACTICES ARE MANDATORY IN THE HUDSON RIVER EXCLUSION: FLY ALONG THE WEST SHORELINE OF THE HUDSON RIVER WHEN SOUTHBOUND, AND ALONG THE EAST SHORELINE OF THE HUDSON RIVER WHEN NORTHBOUND WHILE REMAINING WITHIN THE BOUNDARIES OF THE HUDSON RIVER EXCLUSION. AIRCRAFT OVERFLYING THE AREA WITHIN THE HUDSON RIVER EXCLUSION, BUT NOT LANDING OR DEPARTING ANY OF THE MANHATTAN HELIPOINTS OR LANDING FACILITIES, OR CONDUCTING ANY LOCAL OPERATIONS, MUST TRANSIT THE HUDSON RIVER EXCLUSION AT OR ABOVE AN ALTITUDE OF 1000 FEET MSL UP TO BUT NOT INCLUDING, THE FLOOR OF THE OVERLYING CLASS B AIRSPACE. SELF ANNOUNCE ON THE APPROPRIATE CTAF. AIR TOUR HELICOPTERS MAY DESCEND FROM CLASS B AIRSPACE INTO THE SFRA IN THE VICINITY OF THE GEORGE WASHINGTON BRIDGE. VFR:

WASHINGTON DC SFRA Type: Special Rules Area

Notes: WASHINGTON DC SPECIAL FLIGHT RULES AREA FOR COMPLETE INFORMATION SEE JEPPESEN ADVISORY PAGES 10-1B1 THROUGH 10-1B7. VFR: ATC COMMUNICATION REQUIRED ALL ALTITUDES PRIOR TO ENTRY. SFRA WEST 127.325/236.775 - SFRA EAST 132.775/342.425 - SOUTH 125.125/291.775 WASHINGTON, DC METROPOLITAN AREA SPECIAL FLIGHT RULES AREA/FLIGHT RESTRICTED ZONE ARE IN EFFECT. SPECIAL REGULATIONS APPLY TO ALL AIRCRAFT OPERATIONS FROM THE SURFACE TO BUT NOT INCLUDING FLIGHT LEVEL 180 IN THE WASHINGTON DC METROPOLITAN AREA. PILOTS

SHOULD CONTACT FLIGHT SERVICE FOR NOTAM INFORMATION PRIOR TO FLIGHT IN THE WASHINGTON DC METROPOLITAN AREA. THE WASHINGTON DC FLIGHT RESTRICTED ZONE (DC FRZ) IS WITHIN AND PART OF THE WASHINGTON DC METROPOLITAN AREA SFRA. THE LEESBURG MANEUVERING AREA IS THE AREA DEFINED AS WITHIN THE DC SFRA AND IS THE AIRSPACE AROUND THE LEESBURG EXECUTIVE AIRPORT (JYO) FROM THE SURFACE TO THE FLOOR OF THE CLASS B AIRSPACE , BOUNDED BY THE LINE BEGINNING AT THE WASHINGTON DCA VOR-DME 299° RADIAL AT 30 NM N39 01 39.1 W077 38 26.7, THENCE CLOCKWISE ALONG THE DCA 30 NM ARC TO THE N39 12 42 W077 29 30 OR THE ARMEL AML VOR-DME 004° RADIAL AT 16.6 NM, THENCE SOUTH VIA A LINE DRAWN TO THE N39 03 33 W077 28 37 OR THE AML VOR-DME 004° RADIAL AT 7 NM, THENCE COUNTERCLOCKWISE ALONG THE AML 7 NM ARC TO THE AML 331° RADIAL AT 7 NM N39 01 39.3 W077 33 25.5, THENCE WEST VIA A LINE DRAWN TO THE POINT OF BEGINNING, PURSUANT TO 49 USC 40103(B), THE FEDERAL AVIATION ADMINISTRATION (FAA) CLASSIFIES THE WASHINGTON D.C. METROPOLITAN SFRA/FRZ AS 'NATIONAL DEFENSE AIRSPACE'. PILOTS WHO DO NOT ADHERE TO THE FOLLOWING PROCEDURES MAY BE INTERCEPTED, DETAINED AND INTERVIEWED BY LAW ENFORCEMENT/SECURITY PERSONNEL. SPECIAL AWARENESS TRAINING FOR THE WASHINGTON, D.C. METROPOLITAN AREA 14 CFR PART 91. SECTION 91.161 REQUIRES ANY PILOT WHO FLIES UNDER VFR WITHIN A 60 NAUTICAL MILE RADIUS OF DCA VOR-DME TO COMPLETE THE 'WASHINGTON DC SPECIAL FLIGHT RULES AREA (SFRA)' TRAINING. THIS TRAINING HAS BEEN DEVELOPED AND PROVIDED BY THE FAA ON IT WWW.FAASAFETY.GOV WEBSITE. SEE NOTAMS. VFR:

40 Type: Special Use Airspace

Notes: CONTACT FLIGHT SERVICE FOR LATEST FLIGHT RESTRICTION STATUS AND NOTAMS ASSOCIATED WITH P-40

4006 Type: Special Use Airspace

Notes: EXCLUDES R-4002, R-4005 AND R-6609.

4009 Type: Special Use Airspace

Notes: CONTACT FLIGHT SERVICE FOR LATEST FLIGHT RESTRICTION STATUS AND NOTAMS ASSOCIATED WITH R-4009

4501H Type: Special Use Airspace

Notes: EXCLUDING R-4501B WHEN ACTIVE.

518 Type: Special Use Airspace

Notes: NO PERSON SHALL OPERATE AN AIRCRAFT, INCLUDING MODEL AIRCRAFT, WITHIN THE AREA DESCRIBED UNLESS THE FLIGHT HAS BEEN AUTHORIZED BY THE USER/CONTROLLING AGENCY, EXCEPT FOR MEDICAL, POLICE AND MILITARY AIRCRAFT ON OFFICIAL DUTY FLIGHTS.

537 Type: Special Use Airspace

Notes: NO PERSON SHALL OPERATE AN AIRCRAFT, INCLUDING MODEL AIRCRAFT, WITHIN THE AREA DESCRIBED UNLESS THE FLIGHT HAS BEEN AUTHORIZED BY THE USER/CONTROLLING AGENCY, EXCEPT FOR MEDICAL, POLICE AND MILITARY AIRCRAFT ON OFFICIAL DUTY FLIGHTS AND IFR FLIGHTS.

538 Type: Special Use Airspace

Notes: NO PERSON SHALL OPERATE AN AIRCRAFT, INCLUDING MODEL AIRCRAFT, WITHIN THE AREA DESCRIBED UNLESS THE FLIGHT HAS BEEN AUTHORIZED BY THE USER/CONTROLLING AGENCY, EXCEPT FOR MEDICAL, POLICE AND MILITARY AIRCRAFT ON OFFICIAL DUTY FLIGHTS AND IFR FLIGHTS.

5502B Type: Special Use Airspace

Notes: EXCLUDING R-5502A WHEN ACTIVE.

605 Type: Special Use Airspace

Notes: VERTICAL LIMITS: GND - 3500' MSL BY NOTAM.

620 Type: Special Use Airspace

Notes: NO PERSON SHALL OPERATE AN AIRCRAFT, INCLUDING MODEL AIRCRAFT, WITHIN THE AREA DESCRIBED UNLESS THE FLIGHT HAS BEEN AUTHORIZED BY THE USER/CONTROLLING AGENCY.

633 Type: Special Use Airspace

Notes: UPPER VERTICAL LIMIT OCSL TO FL180.

ADIRONDKB* Type: Special Use Airspace

Notes: EXCLUDING R-5202B WHEN ACTIVE

ADIRONDKC* Type: Special Use Airspace

Notes: EXCLUDING R-5202B WHEN ACTIVE

ADIRONDKD* Type: Special Use Airspace

Notes: EXCLUDING R-5202B WHEN ACTIVE

DC FRZ Type: Special Use Airspace

Notes: WASHINGTON DC FLIGHT RESTRICTION ZONE: FOR COMPLETE INFORMATION SEE JEPPESEN ADVISORY PAGES 10-1B1 THROUGH 10-1B7. VFR: ATC COMMUNICATION REQUIRED ALL ALTITUDES PRIOR TO ENTRY. SFRA WEST 127.325/236.775 - SFRA EAST 132.775/342.425 - SOUTH 125.125/291.775 WASHINGTON, DC METROPOLITAN AREA SPECIAL FLIGHT RULES AREA/FLIGHT RESTRICTED ZONE ARE IN EFFECT. SPECIAL REGULATIONS APPLY TO ALL AIRCRAFT OPERATIONS FROM THE SURFACE TO BUT NOT INCLUDING FLIGHT LEVEL 180 IN THE WASHINGTON DC METROPOLITAN AREA. PILOTS SHOULD CONTACT FLIGHT SERVICE FOR NOTAM INFORMATION PRIOR TO FLIGHT IN THE WASHINGTON DC METROPOLITAN AREA. THE WASHINGTON DC FLIGHT RESTRICTED ZONE (DC FRZ) IS WITHIN AND PART OF THE WASHINGTON DC METROPOLITAN AREA SFRA. THE LEESBURG MANEUVERING AREA IS THE AREA DEFINED AS WITHIN THE DC SFRA AND IS THE AIRSPACE AROUND THE LEESBURG EXECUTIVE AIRPORT (JYO) FROM THE SURFACE TO THE FLOOR OF THE CLASS B AIRSPACE , BOUNDED BY THE LINE BEGINNING AT THE WASHINGTON DCA VOR-DME 299° RADIAL AT 30 NM N39 01 39.1 W077 38 26.7, THENCE CLOCKWISE ALONG THE DCA 30 NM ARC TO THE N39 12 42 W077 29 30 OR THE ARMEL AML VOR-DME 004° RADIAL AT 16.6 NM, THENCE SOUTH VIA A LINE DRAWN TO THE N39 03 33 W077 28 37 OR THE AML VOR-DME 004° RADIAL AT 7 NM, THENCE COUNTERCLOCKWISE ALONG

THE AML 7 NM ARC TO THE AML 331° RADIAL AT 7 NM N39 01 39.3 W077 33 25.5, THENCE WEST VIA A LINE DRAWN TO THE POINT OF BEGINNING, PURSUANT TO 49 USC 40103(B), THE FEDERAL AVIATION ADMINISTRATION (FAA) CLASSIFIES THE WASHINGTON D.C. METROPOLITAN SFRA/FRZ AS 'NATIONAL DEFENSE AIRSPACE'. PILOTS WHO DO NOT ADHERE TO THE FOLLOWING PROCEDURES MAY BE INTERCEPTED, DETAINED AND INTERVIEWED BY LAW ENFORCEMENT/SECURITY PERSONNEL. SPECIAL AWARENESS TRAINING FOR THE WASHINGTON, D.C. METROPOLITAN AREA 14 CFR PART 91. SECTION 91.161 REQUIRES ANY PILOT WHO FLIES UNDER VFR WITHIN A 60 NAUTICAL MILE RADIUS OF DCA VOR-DME TO COMPLETE THE 'WASHINGTON DC SPECIAL FLIGHT RULES AREA (SFRA)' TRAINING. THIS TRAINING HAS BEEN DEVELOPED AND PROVIDED BY THE FAA ON IT WWW.FAASAFETY.GOV WEBSITE. SEE NOTAMS. VFR:

DCVFR Type: Special Use Airspace

Notes: SPECIAL AWARENESS TRAINING IS REQUIRED FOR PILOTS WHO FLY UNDER VFR WITHIN A 60NM RADIUS OF DCA VORDME VFR: ALL VFR AIRCRAFT OPERATIONS WITHIN THE AIRSPACE BETWEEN 30NM RADIUS AND 60NM RADIUS OF DCA VORDME FROM THE SURFACE UP TO BUT NOT INCLUDING FL180 ARE RESTRICTED TO AN INDICATED AIRSPEED OF 230 KTS OR LESS, IF CAPABLE. IF UNABLE THE PILOT MUST CONTACT THE APPROPRIATE ATC FACILITY AND ADVISE THEM OF THE AIRCRAFT'S OPERATIONAL LIMITATIONS PRIOR TO ENTERING THE 60NM RADIUS OF DCA VORDME VFR:

EVERS LOW Type: Special Use Airspace

Notes: EXCLUDING THE AIRSPACE FROM THE SURFACE TO 2500 FT AGL WITHIN A 2.5 NAUTICAL-MILE RADIUS OF THE GREEN BANK OBSERVATORY, WV, CENTERED ON LAT 38°25'59"N., LONG. 79°50'23"W.

LMA Type: Special Use Airspace

Notes: EXCLUDES CLASS B AIRSPACE. COMPLIANCE WITH LMA REQUIREMENTS DOES NOT AUTHORIZE OPERATIONS IN THE DC SFRA OUTSIDE OF THE LMA, WHICH MUST BE IN COMPLIANCE WITH DC SFRA NOTAM AND 14 CFR SECTIONS 93.335, 93.337, 93.339, 93.341, 93.343, 93.345, AND 99.7. B. THE LMA IS PART OF THE DC SFRA, WHICH THE FAA HAS ESTABLISHED AS 'NATIONAL DEFENSE AIRSPACE' PURSUANT TO 49 USC 40103(B)(3). PERSONS OPERATING IN THE LMA WHO DO NOT ADHERE TO THE PROCEDURES PRESCRIBED BY 14 CFR SECTIONS 93.335, 93.337, 93.339, AND 99.7, AND LMA-SPECIFIC INSTRUCTIONS MAY FACE RESPONSE AND ENFORCEMENT ACTIONS DESCRIBED BY THE DC SFRA AND DC FRZ NOTAMS. OPERATING REQUIREMENTS CAN BE FOUND IN FDC NOTAM 6/7215.

MINNOW Type: Special Use Airspace

Notes: EXCLUDING THAT AIRSPACE WITHIN R-6903 WHEN ACTIVATED.

N29 Type: Special Use Airspace

Notes: ATC communication required all altitudes prior to entry. SFRA WEST 127.325 / SFRA EAST 132.775 / SFRA SOUTH 125.125.

Washington DC Metropolitan SFRA/FRZ restrictions are in effect. Special regulations apply to all aircraft operations from GND-FL180 in the Washington DC Metropolitan Area. Pilots should contact a local FSS for NOTAM information prior to flight.

ONTONAGON Type: Special Use Airspace

Notes: EXCLUDING THE AIRSPACE AT AND BELOW 1500 FEET AGL WITHIN A 3 NM RADIUS OF THE ONTONAGON COUNTY - SCHUSTER FIELD AIRPORT.

PIKE EAST Type: Special Use Airspace

Notes: EXCLUDING THAT AIRSPACE WITHIN R-4207 WHEN ACTIVATED.

SALEM Type: Special Use Airspace

Notes: EXCLUDING THAT AIRSPACE 1500 FEET AGL AND BELOW WITHIN A 3 NM RADIUS OF VIBURNAM AIRPORT, VIBURNAM, MO.

VOLK WEST Type: Special Use Airspace

Notes: EXCLUDES R-6904A & B WHEN ACTIVATED

KZDC Type: UIR

Notes: CPDLC: CPDLC SERVICES ARE AVAILABLE WITH LOGON ADDRESS OF KUSA IN WASHINGTON FIR CPDLC.

KZID Type: UIR

Notes: CPDLC: CPDLC SERVICES ARE AVAILABLE WITH LOGON ADDRESS OF KUSA IN INDIANAPOLIS FIR CPDLC:

KZKC Type: UIR

Notes: CPDLC: CPDLC SERVICES ARE AVAILABLE WITH LOGON ADDRESS OF KUSA IN KANSAS CITY FIR CPDLC:

KZMP Type: UIR

Notes: CPDLC: CPDLC SERVICES ARE AVAILABLE WITH LOGON ADDRESS OF KUSA IN MINNEAPOLIS FIR CPDLC.

Regional Notes

Page 1 Strip Charts

CZEG Type: FIR

RNP PROCEDURES

Within RNP (Required Navigation Performance Capability) airspace aircraft may use established RNAV Routes, provided the aircraft is certificated in accordance with the RNP concept.

CZWG Type: FIR

RNP PROCEDURES

Within RNP (Required Navigation Performance Capability) airspace aircraft may use established RNAV Routes, provided the aircraft is certificated in accordance with the RNP concept.

KZAK Type: FIR

VHF EMERGENCY FREQUENCY REQUIREMENTS

VHF EMERGENCY FREQUENCY REQUIREMENT Pilots should remember that there is a need to continuously guard the VHF emergency frequency 121.5 MHz when on long over-water flights, except when communications on other VHF channels, equipment limitations, or cockpit duties prevent simultaneous guarding of two channels. Guarding of 121.5 MHz is particularly critical when operating in proximity to flight information region (FIR) boundaries since it serves to facilitate communications with regard to aircraft which may experience in-flight emergencies, communications, or navigational difficulties.

CPDLC LOGON

Controller Pilot Data Link Communications (CPDLC) aircraft entering Guam ARTCC contact Guam CERAP 250NM out on 118.7, squawk 2100.

REGIONAL WARNINGS

All pilots should avoid the Kaena Point Satellite Tracking Station. Electromagnetic radiation will continuously exist 2800' above antenna systems along a 3 mile stretch of mountain ridge. Aircraft flying within this airspace will be exposed to direct radiation which may produce harmful effects to personnel and equipment.

REGIONAL WARNINGS

All pilots should avoid the Kokee NASA Telemetry Station. Electromagnetic radiation will continuously exist within a 2500' radius and 2500' above antenna. Aircraft flying within this airspace will be exposed to direct radiation which may produce harmful effects to personnel and equipment.

KZDV Type: FIR

FAA Q Routes (CONUS)

Not including Q routes in the Gulf of Mexico - GNSS or DME/DME/IRU RNAV required, unless otherwise indicated. DME/DME/IRU aircraft require radar surveillance. Refer to Jeppesen Enroute pages for DME information.

NOTICE

VFR Operations: PILOTS ARE REQUESTED TO AVOID LANDING OR HOVERING AT TABLE MOUNTAIN FIELD SITE.

MAGNETIC DISTURBANCE

VFR Operations: Magnetic disturbance of as much as 13Â° exists at ground level at Manitou Springs.

INTENSIVE FLIGHT TRAINING AND PARACHUTE JUMPING AREA

VFR Operations: Pilots are requested to avoid flight in the vicinity of the USAF Academy due to intensive student pilot training and parachute jumping, surface to 17,500' MSL. See Airport/Facility Directory for hours of operation. Suggest flight east of I-25 at or above 9000' MSL. For advisory information, contact Academy Tower on 124.15 MHz.

KZLC Type: FIR

MILITARY OPERATIONS

Military operations south of J-58-80 and west of J-9-107, direct routings normally unavailable.

FAA Q Routes (CONUS)

Not including Q routes in the Gulf of Mexico - GNSS or DME/DME/IRU RNAV required, unless otherwise indicated. DME/DME/IRU aircraft require radar surveillance. Refer to Jeppesen Enroute pages for DME information.

KZSE Type: FIR

FAA Q Routes (CONUS)

Not including Q routes in the Gulf of Mexico - GNSS or DME/DME/IRU RNAV required, unless otherwise indicated. DME/DME/IRU aircraft require radar surveillance. Refer to Jeppesen Enroute pages for DME information.

MAGNETIC DISTURBANCE

VFR Operations: Magnetic disturbance of as much as 6Â° exists at ground level between Maple Valley and Cedar Grove.

Page 2 Strip Charts

CZEG Type: FIR

RNP PROCEDURES

Within RNP (Required Navigation Performance Capability) airspace aircraft may use established RNAV Routes, provided the aircraft is certificated in accordance with the RNP concept.

CZWG Type: FIR

RNP PROCEDURES

Within RNP (Required Navigation Performance Capability) airspace aircraft may use established RNAV Routes, provided the aircraft is certificated in accordance with the RNP concept.

KZAU Type: FIR

FAA Q Routes (CONUS)

Not including Q routes in the Gulf of Mexico - GNSS or DME/DME/IRU RNAV required, unless otherwise indicated. DME/DME/IRU aircraft require radar surveillance. Refer to Jeppesen Enroute pages for DME information.

KZDV Type: FIR

FAA Q Routes (CONUS)

Not including Q routes in the Gulf of Mexico - GNSS or DME/DME/IRU RNAV required, unless otherwise indicated. DME/DME/IRU aircraft require radar surveillance. Refer to Jeppesen Enroute pages for DME information.

NOTICE

VFR Operations: PILOTS ARE REQUESTED TO AVOID LANDING OR HOVERING AT TABLE MOUNTAIN FIELD SITE.

MAGNETIC DISTURBANCE

VFR Operations: Magnetic disturbance of as much as 13Â° exists at ground level at Manitou Springs.

INTENSIVE FLIGHT TRAINING AND PARACHUTE JUMPING AREA

VFR Operations: Pilots are requested to avoid flight in the vicinity of the USAF Academy due to intensive student pilot training and parachute jumping, surface to 17,500' MSL. See Airport/Facility Directory for hours of operation. Suggest flight east of I-25 at or above 9000' MSL. For advisory information, contact Academy Tower on 124.15 MHz.

KZLC Type: FIR

MILITARY OPERATIONS

Military operations south of J-58-80 and west of J-9-107, direct routings normally unavailable.

FAA Q Routes (CONUS)

Not including Q routes in the Gulf of Mexico - GNSS or DME/DME/IRU RNAV required, unless otherwise indicated. DME/DME/IRU aircraft require radar surveillance. Refer to Jeppesen Enroute pages for DME information.

KZMP Type: FIR

FAA Q Routes (CONUS)

Not including Q routes in the Gulf of Mexico - GNSS or DME/DME/IRU RNAV required, unless otherwise indicated. DME/DME/IRU aircraft require radar surveillance. Refer to Jeppesen Enroute pages for DME information.

Page 3 Strip Charts

CZEG Type: FIR

RNP PROCEDURES

Within RNP (Required Navigation Performance Capability) airspace aircraft may use established RNAV Routes, provided the aircraft is certificated in accordance with the RNP concept.

CZUL Type: FIR

RNP PROCEDURES

Within RNP (Required Navigation Performance Capability) airspace aircraft may use established RNAV Routes, provided the aircraft is certificated in accordance with the RNP concept.

CZWG Type: FIR

RNP PROCEDURES

Within RNP (Required Navigation Performance Capability) airspace aircraft may use established RNAV Routes, provided the aircraft is certificated in accordance with the RNP concept.

CZYZ Type: FIR

RNP PROCEDURES

Within RNP (Required Navigation Performance Capability) airspace aircraft may use established RNAV Routes, provided the aircraft is certificated in accordance with the RNP concept.

KZAU Type: FIR

FAA Q Routes (CONUS)

Not including Q routes in the Gulf of Mexico - GNSS or DME/DME/IRU RNAV required, unless otherwise indicated. DME/DME/IRU aircraft require radar surveillance. Refer to Jeppesen Enroute pages for DME information.

KZBW Type: FIR

FAA Q Routes (CONUS)

Not including Q routes in the Gulf of Mexico - GNSS or DME/DME/IRU RNAV required, unless otherwise indicated. DME/DME/IRU aircraft require radar surveillance. Refer to Jeppesen Enroute pages for DME information.

KZDC Type: FIR

FAA Q Routes (CONUS)

Not including Q routes in the Gulf of Mexico - GNSS or DME/DME/IRU RNAV required, unless otherwise indicated. DME/DME/IRU aircraft require radar surveillance. Refer to Jeppesen Enroute pages for DME information.

MAGNETIC DISTURBANCE

VFR Operations: Magnetic disturbance up to 8Å° exists at sea level from N39 17, W076 16 to N39 30, W075 54.

AREA OF HEAVY CONGESTION

VFR Operations: THE ENTIRE BALTIMORE-WASHINGTON AREA IS HEAVILY CONGESTED WITH MANY DIFFERENT AIRCRAFT TYPES. THESE ROUTE SUGGESTIONS ARE NOT STERILE OF OTHER TRAFFIC; THEY ARE AREA WE BELIEVE LEAST CONGESTED IN AN ARE OF HEAVY CONGESTION. PILOT ADHERENCE TO VFR RULES MUST BE EXERCISED AT ALL TIMES. COMMUNICATION MUST BE MAINTAINED BETWEEN AIRCRAFT AND CONTROL TOWERS WHILE IN CLASS D AIRSPACE.

KZID Type: FIR

FAA Q Routes (CONUS)

Not including Q routes in the Gulf of Mexico - GNSS or DME/DME/IRU RNAV required, unless otherwise indicated. DME/DME/IRU aircraft require radar surveillance. Refer to Jeppesen Enroute pages for DME information.

KZKC Type: FIR

FAA Q Routes (CONUS)

Not including Q routes in the Gulf of Mexico - GNSS or DME/DME/IRU RNAV required, unless otherwise indicated. DME/DME/IRU aircraft require radar surveillance. Refer to Jeppesen Enroute pages for DME information.

KZME Type: FIR

FAA Q Routes (CONUS)

Not including Q routes in the Gulf of Mexico - GNSS or DME/DME/IRU RNAV required, unless otherwise indicated. DME/DME/IRU aircraft require radar surveillance. Refer to Jeppesen Enroute pages for DME information.

KZMP Type: FIR

FAA Q Routes (CONUS)

Not including Q routes in the Gulf of Mexico - GNSS or DME/DME/IRU RNAV required, unless otherwise indicated. DME/DME/IRU aircraft require radar surveillance. Refer to Jeppesen Enroute pages for DME information.

KZNY Type: FIR

NATIONAL DEFENSE OPERATING AREAS

VFR Operations: Warning: National Defense Areas Operations hazardous to the flight of aircraft conducted within these areas.

AIR TOUR OPERATIONS

VFR Operations: Heavy concentration of air tour operations at 500' AGL in the vicinity of Statue of Liberty and Ellis Island. Air tour helicopters may initiate a climb to higher altitude in this vicinity. Pilots should avoid overflying these areas and maintain appropriate lateral distance.

CAUTION

VFR Operations: CAUTION: USAF PAVE PAW Radar Hazardous to Aircraft 1 NM radius N41 45.1 W070 32.3 GND to 4500' MSL.

KZOB Type: FIR

FAA Q Routes (CONUS)

Not including Q routes in the Gulf of Mexico - GNSS or DME/DME/IRU RNAV required, unless otherwise indicated. DME/DME/IRU aircraft require radar surveillance. Refer to Jeppesen Enroute pages for DME information.

VFR AIRSPACE RESTRICTION

VFR Operations: No VFR flight within Canadian Class B Airspace is permitted above 12,500' MSL, or MEA, whichever is higher, to but not including 18,000' MSL without being controlled by ATC. For additional details see appropriate Canadian publications.

KZWH Type: FIR

COMMUNICATION PROCEDURES

Flights from the SAM/CAR regions entering New York MNPSA via New York OCA do not need to obtain Oceanic Clearance from New York OAC until establishing first contact with New York on HF via ARINC.

TRANSPONDER OPERATIONS

TRANSPONDER OPERATION: Unless otherwise directed by ATC, and except in cases of emergency or radio failure, pilots of aircraft flying in the NAT Region shall operate transponders continuously on Mode A/C, Code 2000 all directions, except that the last assigned Code shall be retained for 30 minutes after entry into NAT airspace. Aircraft operating within the SOTA have to select Mode A/C, Codes will be allocated by Shannon ATCC. Reykjavik ATC provides Radar Control service in the southeastern part of its area ; thus transponder codes issued must be retained throughout Reykjavik OCA until advised by ATC. All aircraft transitioning from Miami Center and San Juan CERAP into the WATRS Area via fixed ATS routes shall remain on their last assigned beacon code.

Reference Notes

Page 1 Strip Charts

CZEG Type: FIR

USE OF DND AND CIVIL HIGH ARCTIC AERODROMES

USE OF DND AND CIVIL HIGH ARCTIC AERODROMES: Civil operators must obtain permission from DND to use High Arctic Aerodromes in Canada. See Entry Requirements Tab.

CANADIAN DOMESTIC AIRSPACE (DOMESTIC CLEARANCE)

- a. North Atlantic (NAT) West-bound Traffic.

1. Pilots proceeding westbound across the North Atlantic (NAT) and entering Canadian Domestic Airspace (CDA) within the Gander, Moncton and Montreal FIRs should comply with the following procedures:

(a) Flights cleared by ATC via the flight planned route prior to reaching CDA will not be issued en-route clearances upon entering domestic airspace, and are to follow the flight planned route as cleared.

(b) Domestic en-route clearances will be issued for flights that have been rerouted and exit oceanic airspace at other than the flight planned exit fix, at a pilot's request for another routing or if a flight plan has not been received by the ACC.

2. If entering Canadian Domestic Airspace within the Edmonton FIR, the onward domestic routing will have been established in coordination between the Reykjavik and Edmonton ACCs, and additional domestic clearance is not normally required. However, if there has been a change in route from the filed flight plan, clarification of the onward routing may be obtained from Edmonton ACC on request.

TRANSPONDER SETTING (Secondary Surveillance Radar-SSR) For Beacon Code procedures see Enroute Tab.

CZVR Type: FIR

MACH NUMBER TECHNIQUE For information about routes and/or areas affected, see Air Traffic Control Tab.

TRANSPONDER SETTING (Secondary Surveillance Radar-SSR) For Beacon Code procedures see Enroute Tab.

CZWG Type: FIR

TRANSPONDER SETTING (Secondary Surveillance Radar-SSR) For Beacon Code procedures see Enroute Tab.

KZAK Type: FIR

FLIGHT PLANNING AND OVERFLIGHT ROUTES within the Pacific region: For complete information see Enroute Tab.

ADIZ REQUIREMENTS

FOR ADIZ REQUIREMENTS See Enroute Tab.

EXTENDED RANGE OPERATIONS BY AIRCRAFT WITH TWO-TURBINE POWER-UNITS (ETOPS) 1. If the contingency procedures are employed by a twin-engine aircraft as a result of an engine shutdown or failure of an ETOPS critical system, the pilot should advise ATC as soon as practicable of the situation, reminding ATC of the type of aircraft involved, and request expeditious handling.

OCEANIC POSITION REPORTING PROCEDURES OAKLAND OCEANIC FIR

1. For non ADS equipped aircraft, any waypoint filed in the route of flight (Item 15 of the ICAO flight plan) must be reported as a position report whether the filed waypoint is compulsory or not. If a noncompulsory waypoint is not filed in item 15, it does not need to be reported.

2. POSITION REPORTS

a. When operating on a published ATS Route or a temporary route established by NOTAM, report and estimate the designated reporting points using the specified waypoint names or geographic coordinates as specified in the NOTAM.

b. When operating on a random route:

1. Flights whose tracks are predominantly east and west shall report over each 5° degrees or 10° degrees (10° degrees will be used if the speed of the aircraft is such that 10° degrees will be traversed within 80 minutes or less) meridian longitude extending east and west from 180° degrees.

2. Flights whose tracks are predominantly north and south shall report over each 5° degrees or 10° degrees (10° degrees if traversed within 80 minutes) parallel of latitude extending north and south of the equator.

c. ATC may require specific flights to report more frequently than each 5° degrees for aircraft with slow ground speeds.

d. Position reports shall be transmitted at the time of crossing the designated reporting point or as soon thereafter as possible.

3. Position reports shall include information on present position, estimated next position, and ensuing position in sequence as indicated below.

a. PRESENT POSITION - Information shall include:

1. The word "position" .

2. Aircraft identification.

3. Reporting point name, or if not named:

(a) Latitude (2 digits or more) and,

(b) Longitude (3 digits or more).

b. Time over reporting point (4 digits UTC).

c. Altitude (Flight Level). When forwarding an altitude report within the Oakland OCA/FIR, pilots should report their present altitude and their assigned altitude exactly as cleared if the present and assigned altitudes differ. Aircraft assigned a block altitude must report their current altitude and the assigned block altitude. A restriction to cross a point at an altitude is not a block altitude assignment and should not be reported as a block of altitudes.

d. ESTIMATED NEXT POSITION

(1) Reporting point name, or if not named, latitude and longitude as in a.3 above and,

(2) Estimated time over next position (4 digits UTC).

e. ENSUING FIX

(1) Name only of the next succeeding fix whether compulsory or not, or if not named, latitude and longitude as in a.3 above.

4. WEATHER REPORTS:

a. Weather reports shall be included as provided in Section 3 of Standard AIREP Form by all flights unless exempted from weather reporting by the Weather Service and/or ATC.

5. ADHERENCE TO ATC APPROVED ROUTE

a. If an aircraft, notwithstanding all action taken to adhere to the route specified in the ATC clearance, inadvertently deviates from this route, action shall be taken to regain it as soon as reasonable and not further ahead than 200 nautical miles from the DR position at which the heading was altered to regain the route specified in the ATC clearance. Action to regain this route shall not be delayed in anticipation of obtaining a requested re-clearance.

6. EXCEPTIONS TO POSITION REPORTS PROCEDURES

a. Within Oakland OCA/FIR, no 5° degree report need be made that would fall within 100° NM of Guam. Aircraft cleared via terminal area routes report compulsory reporting fixes. Other aircraft report 100° NM from Nimitz VORTAC. Where other island destinations within the Oakland Oceanic FIR are not more than one-degree latitude-longitude from a 5° degrees fixed line reporting point, the ETA and arrival report may be substituted in lieu of the adjacent fixed line report.

b. To the east of the Hawaiian Islands it will not be necessary to report the 155° degree west position if position will be reported at the entry/exit fixes on the Honolulu Control Facility boundary. To the west of the Hawaiian Islands, the 160° degree west need not be reported.

NORTH PACIFIC (NOPAC) ROUTE PROCEDURES

a. The NOPAC Route System is comprised of five Air Traffic Service (ATS) routes which transit the North Pacific between Alaska and Japan. The two northern routes are used for westbound traffic. The three southern routes are used for eastbound traffic, except that R-591 or G-344 may be used for westbound aircraft crossing the Fukuoka/Anchorage FIR between 0000UTC and 0600UTC. The routes are as follows: R-220, R-580, A-590, R-591 and G-344.

b. Transition Routes

1. Within the Fukuoka FIR, Oceanic Transition Routes (OTRs) and, in one case, a Victor route, have been established for aircraft transitioning to or from the NOPAC Route System.

2. Within the Anchorage FIR, certain ATS routes are used for the same purpose. They are as follows: B-327 (For Westbound use only between BAMOK and SELDM), R-341, G-469, A-342, G-215, R-330, R-451, R-336, R-338, G-583 and G-349.

c. Separation Standards

1. The primary form of lateral separation within the NOPAC Route System is 25NM lateral either side of the centerline, based on Required Navigation Performance 10 (RNP-10) and 1000' vertical separation (FL290 - FL410) based on Reduced Vertical Separation Minimums (RVSM).

2. Lateral separation for Non-RNP10 aircraft and aircraft operating below FL180 is 50NM lateral either side of the centerline.

3. Standard longitudinal separation within the Anchorage Oceanic FIR is 15 minutes "in trail".

d. Flight Plans

1. Aircraft shall enter "R" in item 10 of the ICAO flight plan if the aircraft and operator have been approved for RNP 10 operations for the route of flight.

2. Aircraft shall enter "W" in item 10 of the ICAO flight plan if the aircraft and operator have been approved for RVSM.

3. Aircraft not approved for RNP 10 and/or RVSM shall not enter "R" and/or "W" in item 10.

4. Aircraft approved for both RNP 10 and RVSM may flight plan any of the NOPAC routes with the following altitude restrictions:

(a) R-220: Even Altitudes FL180 to FL400, also FL330, FL350, FL370, FL390, FL410

(b) R-580: Even Altitudes FL180 to FL400, also FL350, FL370

(c) A-590: Odd Altitudes FL190 to FL410, also FL300, FL320, FL340

(d) R-591: Eastbound, Odd Altitudes FL190 to FL410

(e) R-591: Westbound, Even Altitudes FL300 to FL400

(f) G-344: Eastbound, Odd Altitudes FL190 to FL410

(g) G-344: Westbound, Even Altitudes FL300 to FL400

(h) R-591 and G-344 are Eastbound routes unless designated as Westbound PACOTS. Traffic flows are either Eastbound or Westbound with the tracks being emptied of traffic before changing direction.

5. Non-RNP-10 aircraft shall flight plan as follows:

(a) Westbound: R-220 at all times.

(b) Eastbound: A-590 at all times.

(c) Eastbound: G-344 when available for eastbound flights.

(d) The altitudes available on these routes are at or below FL280 and at or above FL430.

e. Procedures

1. Peak traffic periods:

(a) Eastbound - 0700UTC to 2100UTC

(b) Westbound - 1200UTC to 1900UTC and 2200UTC to 0800UTC

(c) Due to traffic volume, flights desiring to operate contrary to the predominant traffic flow can expect to be rerouted or assigned less than optimum flight levels. If feasible, users planning to operate in the NOPAC Route System at airspeeds below MACH 0.78 should use other than the peak hours for their flights. This will reduce congestion and expedite traffic.

f. Aircraft cannot always be accommodated on their flight planned NOPAC route. In an effort to reduce coordination time and errors between ATC and flight crews, JCAB (Fukuoka ATMC) and FAA (Anchorage ARTCC) have agreed on a common procedure to accommodate most reroutes. Aircraft rerouted from one NOPAC ATC route to another NOPAC ATC route will be given short range clearances into the adjoining FIR's RADAR coverage airspace. The receiving ATC facility will then issue further routing to the aircraft prior to the aircraft reaching the clearance limit.

1. Example 1: aircraft ABC101 is routed via R-220 to RJTT but can not be accommodated on R-220. The aircraft may be re-cleared as follows: "ABC101 cleared to OATIS via R-580, expect further clearance from ATMC after OMOTO."

2. Example 2: aircraft ABC102 is routed via A-590 to PAFA but can not be accommodated on A-590. The aircraft may be re-cleared as follows: "ABC102 cleared to SYA via R-591, expect further routing from Anchorage ARTCC after AKISU."

CENTRAL EAST PACIFIC ROUTE SYSTEM (HAWAII & U.S. MAINLAND)

- a. The Central East Pacific (CEP) is the organized route system between Hawaii and California. Seven ATS routes, R-463, R-464, R-465, R-585, R-576, R-577 and R-578 are the primary routes within the CEP.
- b. Reduced Vertical Separation Minimum (RVSM) and Required Navigation Performance 10 (RNP-10) are required for aircraft operating within the CEP Route System at FL290 through FL410. Non-approved aircraft can expect FL280 and below or FL430 and above, traffic permitting.
- c. Operators show approval for RVSM and RNP-10 by annotating block 10 of the ICAO flight plan (equipment) with the letter W and R respectively.
- d. Flight Levels normally assigned in the CEP are in accordance with ICAO Appendix 3a (East odd, West even).

ATS ROUTE RESTRICTION NOTES

ATS Route Restriction Notes for information regarding flight planning purposes see Enroute Tab.

RNP-10 SEPARATION

RNP-10 lateral separation (50 NM) may be applied within the Oakland Oceanic FIR between RNP-10 approved aircraft. RNP-10 approval is required for all PACOTS and for all aircraft operating within the CEP at FL290 through FL410. Non-RNP approved aircraft can expect FL280 and below or FL430 and above, traffic permitting.

MACH NUMBER TECHNIQUE For information about routes and/or areas affected, see Air Traffic Control Tab.

RVSM PROCEDURES

REDUCED VERTICAL SEPARATION MINIMUMS (RVSM) For procedures and equipment requirements see Air Traffic Control Tab.

REQUIRED NAVIGATION PERFORMANCE (RNP)

For procedures and equipment requirements, see Air Traffic Control pages and/or Air Traffic Control State pages for detailed information.

SPECIAL PROCEDURES FOR IN-FLIGHT CONTINGENCIES IN OCEANIC AIRSPACE ICAO DOC 4444, SECTION 15.2

Introduction

1. Although all possible contingencies cannot be covered, these procedures provide for the more frequent cases such as:

- a. Inability to comply with assigned clearance due to meteorological conditions.
- b. En-route diversion across the prevailing traffic flow; and
- c. Loss of, or significant reduction in, the required navigation capability when operating in an airspace where the navigation performance accuracy is a prerequisite to the safe conduct of flight operations, or pressurization failure.

2. General Procedures

1. If an aircraft is unable to continue the flight in accordance with its ATC clearance, a revised clearance shall be obtained, whenever possible, prior to initiating any action.

2. If prior clearance cannot be obtained, the following contingency procedures should be employed until a revised clearance is received. In general terms, the aircraft should be flown at an offset level and on an offset track where other aircraft are less likely to be encountered. Specifically, the pilot shall:

- a. Leave the cleared track or ATS route by initially turning at least 30 degrees to the right or to the left, in order to establish and maintain a parallel, same direction track or ATS route offset 5 NM (9.3 km). The direction of the turn should be based on one or more of the following factors:

- 1) aircraft position relative to any organized track or ATS route system;
- 2) the direction of flights and flight levels allocated on adjacent tracks;
- 3) the direction to an alternate airport;
- 4) any strategic lateral offset being flown; and
- 5) terrain clearance.

- b. Maintain a watch for conflicting traffic both visually and by reference to ACAS (if equipped), leaving ACAS in RA mode at all times, unless aircraft operating limitations dictate otherwise;

- c. turn on all aircraft exterior lights (commensurate with appropriate operating limitations);

- d. keep the SSR transponder on at all times and, when able, squawk 7700, as appropriate and, if equipped with ADS-B or ADS-C, select the appropriate emergency functionality;

- e. as soon as practicable, advise air traffic control of any deviation from their assigned clearance;

f. use means as appropriate (ie. voice and/or CPDLC) to communicate during a contingency or emergency;

g. if voice communications are used, the radiotelephony distress signal (MAYDAY) or urgency signal (PAN PAN) preferably spoken three times, shall be used, as appropriate;

h. when emergency situations are communicated via CPDLC, the controller may respond via CPDLC. However, the controller may also attempt to make voice contact with the aircraft;

i. establish communications with and alert nearby aircraft by broadcasting on the frequencies in use and at suitable intervals on 121.5 MHz (or, as a backup, on the inter-pilot air-to-air frequency 123.45 MHz): aircraft identification, the nature of the distress condition, intention of the pilot, position (including the ATS route designator or the track code, as appropriate) and flight level; and

j. the controller should attempt to determine the nature of the emergency and ascertain any assistance that may be required. Subsequent ATC action with respect to that aircraft shall be based on the intentions or the pilot and overall traffic situation.

3. Actions to be taken once offset from track:

a) operation within a parallel track system;

b) the potential for user preferred routes (UPR's) parallel to the aircraft's track or ATS route;

c) the nature of the contingency (e.g. aircraft system malfunction); and

d) weather factors (e.g. convective weather at lower flight levels).

4. If possible, maintain the assigned flight level until established on the 9.3 km (5.0 NM) parallel, same direction track or ATS route offset. If unable, initially minimize the rate of descent to the extent that is operationally feasible.

5. Once established on a parallel, same direction track or ATS route offset by 9.3km (5.0 NM), either:

a) descend below FL 290, and establish a 150 m (500 ft) vertical offset from those flight levels normally used, and proceed as required by the operational situation or if an ATC clearance has been obtained, in accordance with the clearance; or

b) establish a 150 m (500 ft) vertical offset (or 300 m (1000 ft) vertical offset if above FL 410) from those flight levels normally used, and proceed as required by the operational situation, or if ATC clearance has been obtained, in accordance with the clearance.

WEATHER DEVIATION PROCEDURES FOR OCEANIC CONTROLLED AIRSPACE – PACIFIC

When weather deviation is required, the pilot should initiate communications with ATC via voice or CPDLC. A rapid response may be obtained by either:

1. stating "WEATHER DEVIATION REQUIRED" to indicate that priority is desired on the frequency and for ATC response; or

2. requesting a weather deviation using a CPDLC lateral downlink message.

When necessary, the pilot should initiate the communications using the urgency call "PAN PAN PAN" (preferably spoken three times) or by using a CPDLC urgency downlink message.

The pilot shall inform ATC when weather deviation is no longer required, or when a weather deviation has been completed and the aircraft has returned to its cleared route.

The pilot should notify ATC and request clearance to deviate from track or ATS route, advising, when possible, the extent of the deviation requested. The flight crew will use whatever means are appropriate (i.e. voice and/or CPDLC) to communicate during a weather deviation.

ATC should take one of the following actions:

1. when appropriate separation can be applied, issue clearance to deviate from track; or

2. if there is conflicting traffic and ATC is unable to establish appropriate separation, ATC shall:

1. advise the pilot of inability to issue clearance for the requested deviation;

2. advise the pilot of conflicting traffic; and

3. request the pilot's intentions.

The pilot should take the following actions:

1. comply with the ATC clearance issued; or

2. advise ATC of intentions and execute the procedures detailed in the Action to be Taken if a Revised ATC Clearance Cannot Be Obtained procedure section.

If the aircraft is required to deviate from track or ATC route to avoid adverse meteorological conditions and prior clearance cannot be obtained, an ATC clearance shall be obtained at the earliest possible time. Until an ATC clearance is received, the pilot shall take the following actions:

1. if possible, deviate away from an organized track or ATS route system;
2. establish communications with and alert nearby aircraft by broadcasting, at suitable intervals: aircraft identification, flight level, position (including ATS route designator or the track code) and intentions, on the frequency in use and on 121.5 MHz (or, as a backup, on the inter-pilot air-to-air frequency 123.45 MHz);
3. watch for conflicting traffic both visually and by reference to ACAS (if equipped);
4. turn on all aircraft exterior lights (commensurate with appropriate operating limitations);
5. for deviations of less than 9.3 km (5.0 NM) from the originally cleared track or ATS route, remain at a level assigned by ATC;
6. for deviations greater than, or equal to 9.3 km (5.0 NM) from the originally cleared track or ATS route, when the aircraft is approximately 9.3 km (5.0 NM) from track, initiate a level change in accordance with the Originally Cleared Track or ATS Route Center Line / Deviations / Level Change section.
7. if the pilot receives clearance to deviate from cleared track or ATS route for a specified distance and, subsequently, requests, but cannot obtain a clearance to deviate beyond that distance, the pilot should apply an altitude offset in accordance with the Originally Cleared Track or ATS Route Center Line / Deviations / Level Change section before deviating beyond the cleared distance;
8. when returning to track or ATS route, be at its assigned flight level when the aircraft is within approximately 9.3 km (5.0 NM) of the center line; and
9. if contact was not established prior to deviating, continue to attempt to contact ATC to obtain a clearance. If contact was established, continue to keep ATC advised of intentions and obtain essential traffic information.

EAST 000° - 179° magnetic

1. DESCEND 300 ft (90 m)
2. CLIMB 300 ft (90 m)

WEST 180° - 359° magnetic

1. CLIMB 300 ft (90 m)
2. DESCEND 300 ft (90 m)

Page 2 Strip Charts

CZEG Type: FIR

USE OF DND AND CIVIL HIGH ARCTIC AERODROMES

USE OF DND AND CIVIL HIGH ARCTIC AERODROMES: Civil operators must obtain permission from DND to use High Arctic Aerodromes in Canada. See Entry Requirements Tab.

CANADIAN DOMESTIC AIRSPACE (DOMESTIC CLEARANCE)

- a. North Atlantic (NAT) West-bound Traffic.

1. Pilots proceeding westbound across the North Atlantic (NAT) and entering Canadian Domestic Airspace (CDA) within the Gander, Moncton and Montreal FIRs should comply with the following procedures:

(a) Flights cleared by ATC via the flight planned route prior to reaching CDA will not be issued en-route clearances upon entering domestic airspace, and are to follow the flight planned route as cleared.

(b) Domestic en-route clearances will be issued for flights that have been rerouted and exit oceanic airspace at other than the flight planned exit fix, at a pilot's request for another routing or if a flight plan has not been received by the ACC.

2. If entering Canadian Domestic Airspace within the Edmonton FIR, the onward domestic routing will have been established in coordination between the Reykjavik and Edmonton ACCs, and additional domestic clearance is not normally required. However, if there has been a change in route from the filed flight plan, clarification of the onward routing may be obtained from Edmonton ACC on request.

TRANSPONDER SETTING (Secondary Surveillance Radar-SSR) For Beacon Code procedures see Enroute Tab.

CZWG Type: FIR

TRANSPONDER SETTING (Secondary Surveillance Radar-SSR) For Beacon Code procedures see Enroute Tab.

Page 3 Strip Charts**CZEG Type: FIR**

USE OF DND AND CIVIL HIGH ARCTIC AERODROMES

USE OF DND and CIVIL HIGH ARCTIC AERODROMES: Civil operators must obtain permission from DND to use High Arctic Aerodromes in Canada. See Entry Requirements Tab.

CANADIAN DOMESTIC AIRSPACE (DOMESTIC CLEARANCE)

- a. North Atlantic (NAT) West-bound Traffic.

1. Pilots proceeding westbound across the North Atlantic (NAT) and entering Canadian Domestic Airspace (CDA) within the Gander, Moncton and Montreal FIRs should comply with the following procedures:

(a) Flights cleared by ATC via the flight planned route prior to reaching CDA will not be issued en-route clearances upon entering domestic airspace, and are to follow the flight planned route as cleared.

(b) Domestic en-route clearances will be issued for flights that have been rerouted and exit oceanic airspace at other than the flight planned exit fix, at a pilot's request for another routing or if a flight plan has not been received by the ACC.

2. If entering Canadian Domestic Airspace within the Edmonton FIR, the onward domestic routing will have been established in coordination between the Reykjavik and Edmonton ACCs, and additional domestic clearance is not normally required. However, if there has been a change in route from the filed flight plan, clarification of the onward routing may be obtained from Edmonton ACC on request.

TRANSPONDER SETTING (Secondary Surveillance Radar-SSR) For Beacon Code procedures see Enroute Tab.

CZUL Type: FIR

CANADIAN DOMESTIC AIRSPACE (DOMESTIC CLEARANCE)

- a. North Atlantic (NAT) West-bound Traffic.

1. Pilots proceeding westbound across the North Atlantic (NAT) and entering Canadian Domestic Airspace (CDA) within the Gander, Moncton and Montreal FIRs should comply with the following procedures:

(a) Flights cleared by ATC via the flight planned route prior to reaching CDA will not be issued en-route clearances upon entering domestic airspace, and are to follow the flight planned route as cleared.

(b) Domestic en-route clearances will be issued for flights that have been rerouted and exit oceanic airspace at other than the flight planned exit fix, at a pilot's request for another routing or if a flight plan has not been received by the ACC.

2. If entering Canadian Domestic Airspace within the Edmonton FIR, the onward domestic routing will have been established in coordination between the Reykjavik and Edmonton ACCs, and additional domestic clearance is not normally required. However, if there has been a change in route from the filed flight plan, clarification of the onward routing may be obtained from Edmonton ACC on request.

TRANSPONDER SETTING (Secondary Surveillance Radar-SSR) For Beacon Code procedures see Enroute Tab.

CZWG Type: FIR

TRANSPONDER SETTING (Secondary Surveillance Radar-SSR) For Beacon Code procedures see Enroute Tab.

KZWY Type: FIR

TRANSPONDER SETTING (Secondary Surveillance Radar-SSR) For Beacon Code procedures see Enroute Tab.

WATRS PLUS ROUTE STRUCTURE OPERATIONAL POLICY AND PROCEDURES

For Operational Policies and Procedures required for flights within the WATRS Plus route structure redesign see Enroute Tab.

WATRS OPERATIONAL POLICIES

WEST ATLANTIC ROUTE SYSTEM (WATRS) PLUS CTAs: For Operational Policy and Procedures refer to ENROUTE section.

NORTH ATLANTIC ORGANIZED TRACK SYSTEM (NAT OTS)

a. Organized Tracks are formulated and published as an AFTN Track Structure Message. The day-time structure, valid from 1130 UTC until 1900 UTC at 030°W is published by Shanwick, and the night-time structure, valid from 0100 UTC until 0800 UTC at 030°W by Gander. To enable oceanic planners to take into consideration the operators preferred route in the construction of the OTS all NAT operators should provide, by AFTN, their proposed flights and optimum tracks. The Preferred Route Message (PRM) should be received by Shanwick (EUCHZMFP and EUCBZMFP) copy Gander (CZQXZQZX) no later than 1000 UTC for the following nighttime OTS and by Gander copy Shanwick no later than 1900 UTC for the following daytime OTS.

b. Flight Planning on OTS:

1. NAT Track Structure Messages are identified by a 3-digit Track Message Identification number (TMI) appearing at the end of the Track Message. This number relates to the day of the year (no reference to month). Any subsequent NAT track amendment(s) on a given day will carry a successive alpha number, i.e. TMI33B would reflect the 2nd amendment of the TMI for the 33rd day of the year. Ensuring that the flight is planned on the correct track of the day is essential. Crews should also be given copy of the track message(s) at time of briefing.

2. Operators should use the Flight Level Allocation Scheme (FLAS) for flight planning guidance:

(a) FL430 - May be flight planned for both East- and Westbound NON-RVSM certified aircraft

(b) FL410 - Eastbound

(c) FL310, 320, 340, 360, 380, 400 - Westbound FL (except within Eastbound OTS)

(d) FL330, 350, 370, 390 - Eastbound FL (except within Westbound OTS)

(e) FL300 and below - Even FLs westbound ; Odd FLs eastbound.

3. 1. Operators are permitted to file flight plans at any flight level for a route which is wholly contained within the routing structure of T13, T16 and T213. Operators are reminded that T13, T16 and T213 are included in the DLM. Flight planning requirements apply for T9 and T290: Item 10A - GRZ Item 18 - NAV/RNP2

4. To accommodate significant single direction demand during OTS times, OACCs may exchange Flight Levels on a tactical basis. This allows additional profiles for main direction flow.

5. During OTS times, aircraft intending to use the OTS may Flight Plan levels which are allocated to the published OTS. Additionally, to accommodate demand:

(a) During the eastbound OTS, eastbound non-OTS aircraft may Flight Plan at FL340 or FL380

(b) During the westbound OTS, westbound non-OTS aircraft may Flight Plan at FL330.

6. Unless suitable eastbound Tracks exist, during the eastbound OTS times, eastbound traffic originating in New York OACC, planned to enter Shanwick OACC, is recommended to Flight Plan as follows:

(a) FL310 or FL340 and restrict routing to landfall BEDRA or south

(b) FL310, FL340 or FL380, and restrict routing to landfall either: BEDRA or south, or to remain south of the OTS, whichever is further south.

7. During the westbound OTS, track and random westbound aircraft, flight planned to enter Shanwick and Gander airspace which landfalls BOKTO-AVPUT inclusive should not flight plan at FL340. FL340 is reserved for flights between Reykjavik OACC and Gander OACC.

c. Random Flight Planning (Predominantly East - West direction):

1. For flights operating at or South of 70N, the planned tracks shall normally be defined by significant points formed by the intersection of half or whole degrees of latitude with meridians spaced at intervals of 10 degrees from the Greenwich meridian to longitude 70W.

2. For flights operating north of 70N and at or south of 80N, the planned tracks shall normally be defined by significant points formed by the intersection of parallels of latitude expressed in degrees and minutes with meridians normally spaced at intervals of 20 degrees from the Greenwich meridian to longitude 60W, using the longitudes 000W, 020W, 040W and 060W.

3. When the flight time between successive significant points is less than 30 minutes, one of these points may be omitted.

(a) at intervals of 10 degrees of longitude (between 5W and 65W) for flights operating at or south of 70N; and

(b) at intervals of 20 degrees of longitude (between 10W and 50W) for flights operating north of 70N and at or south of 80N.

4. For flights operating north of 80N, the planned tracks shall normally be defined by significant points formed by the intersection of parallels of latitude expressed in degrees and minutes with meridians expressed in whole degrees. The distance between significant points shall normally equate to not less than 30 and not more than 60 minutes of flying time.

d. Random Flight Planning (Predominantly North - South direction):

1. For flights whose flight paths at or South of 80N are predominantly oriented in a north-south direction, the planned tracks shall normally be defined by significant points formed by the intersection of whole degrees of longitude with specified parallels of latitude which are spaced at intervals of 5 degrees.

2. For flights operating north of 80N, the planned tracks shall be defined by points of intersection of parallels of latitude expressed in degrees and minutes with meridians expressed in whole degrees. The distance between significant points shall normally equate to not less than 30 and not more than 60 minutes of flying time.

e. After leaving oceanic airspace flight crews maintain their assigned Mach number in domestic controlled airspace unless and until the appropriate ATC unit authorizes a change.

f. If an aircraft has inadvertently deviated from the route specified in the ATC clearance it shall forthwith take action to regain such route within 100 nm from the position at which the deviation was observed.

NORTH ATLANTIC DATA LINK COMMUNICATION PROCEDURES

a. Many NAT air/ground ATC communications are still conducted on single side-band HF frequencies. For unrestricted operations in the NAT region fully functioning HF communications equipment is required. While SATVOICE and data link communications are now in widespread use in NAT operations, HF also constitutes a required back-up.

b. It is important to note that it is equally essential to comply with the foregoing SELCAL provisions even if SATVOICE or CPDLC are being used for routine air/ground ATS communications. This will ensure that ATC has a timely means of contacting the aircraft.

1. provide the SELCAL code in the flight plan; (any subsequent change of aircraft for a flight will require refile of the flight plan or submitting a modification message (CHG) which includes the new registration and SELCAL);

2. check the operation of the SELCAL equipment, at or prior to entry into oceanic airspace, with the appropriate radio station. (This SELCAL check must be completed prior to commencing SELCAL watch); and

3. maintain thereafter a SELCAL watch.

c. Radio operators usually maintain a listening watch on more than one single frequency, therefore it is useful for flight crews to state the frequency used when placing the initial call to the radio station.

d. The carriage of HF communications equipment is mandatory for flight in the Shanwick OCA.

e. In the event of HF communication failure, when so equipped, an aircraft should use Satellite Voice Communications to contact the responsible aeradio station via special telephone numbers/short codes. If not equipped with SATCOM then the flight crew should attempt to use VHF and request relay of position reports via another aircraft. For this purpose the air to air VHF frequency 123.45 MHz may be used. If necessary the initial contact with the other aircraft may be made on 121.5 MHz.

f. The Aeronautical Mobile Satellite (Route) Service (AMS(R)S), more commonly referred to as SATVOICE, can be used as a supplement to HF & CPDLC communications throughout the NAT region for any routine, non-routine or emergency ATS air/ground communications.

g. Radio stations are also responsible for the operation of General Purpose VHF (GP/VHF) outlets. North Atlantic flights may use these facilities for all regular and emergency communications with relevant OACCs.

h. It is important for the flight crew to appreciate that when using GP/VHF, as with HF and SATVOICE, these communications are with a radio station and the flight crew is not in direct contact with ATC. However, contact between the flight crew and ATC can be arranged, if necessary, via patch-through on HF or GP/VHF frequencies by Iceland Radio and Shanwick Radio.

POSITION REPORTING PROCEDURES

a. Unless otherwise requested by ATC, position reports for flights on routes not defined by designated reporting points should be made at the significant points listed in the flight plan.

b. ATC may require any flight operating in a North/South direction to report its position at any intermediate parallel of latitude when deemed necessary.

c. In requiring aircraft to report their position at intermediate points, ATC is guided by the requirement to have positional information at approximately hourly intervals and also by the need to accommodate varying types of aircraft and varying traffic and MET conditions.

d. Unless providing position reports via ADS-C, if the Estimated Time for the "next position", as last reported to ATC has changed by 2 minutes or more, a revised Estimate must be transmitted to the ATS unit concerned as soon as possible.

e. Flight Crews must always report to ATC as soon as possible on reaching any new cruising level.

f. For flights outside domestic ATS route networks, positions should be expressed in terms of latitude and longitude except when flying over named reporting points. For flights whose tracks are predominantly east or west, latitude should be expressed in degrees and minutes, longitude in degrees only. For flights whose tracks are predominantly north or south, latitude should be expressed in degrees only, longitude in degrees and minutes. However, it should be noted that when such minutes are zero then the position report may refer solely to degrees.

STANDARD AIR GROUND MESSAGE TYPES AND FORMATS

a. Aircraft entering, operating within, or leaving the Oceanic Control Areas of Gander, New York, Bodo, Reykjavik, Santa Maria and Shanwick will transmit the elements of information in position reports to the appropriate Oceanic Control.

b. For routine position reports. The phraseology used to indicate the next position on the assigned route is "ESTIMATING", for the following subsequent position "NEXT", "ABLE" or "REQUEST", as applicable for the acceptable or requested next higher FL position or time.

1. Content and Data Sequence:

- (a) "Position"
- (b) Flight identification (additionally state frequency when using HF)
- (c) Present position
- (d) Time over present position (hours and minutes)
- (e) Present Flight level
- (f) Next position on assigned route or OCA entry point
- (g) Estimated time for next position or OCA entry point
- (h) Next subsequent position
- (i) Next higher FL acceptable or requested at Position or Time
- (j) Any further information e.g. MET data or company message

c. In conjunction with a routine position report, to request a change of Mach Number, Flight Level, or route and to request Westbound Oceanic Clearance prior to entering Reykjavik, Santa Maria and Shanwick OCA's.

1. To request a change in Mach Number, or route when a position report message is not appropriate.

- (a) "Request Clearance"
- (b) Flight identification (additionally state frequency when using HF)
- (c) Present or last reported position
- (d) Time over present or last reported position (hours and minutes)
- (e) Present Flight Level
- (f) Next position on assigned route or OCA entry point
- (g) Estimated time for next position or OCA entry point
- (h) Next subsequent position
- (i) Requested Mach Number, Flight Level, or route
- (j) Further information or clarifying remarks

2. Content and Data sequence

- (a) "Request Clearance"
- (b) Flight identification (additionally state frequency when using HF)
- (c) Requested Mach Number, or route
- (d) Further information or clarifying remarks

d. To update time estimate for next position.

1. Content and Data sequence

- (a) "Revised Estimate"
- (b) Flight identification (additionally state frequency when using HF)

(c) Next position on route

(d) Revised estimate for next position (hours and minutes)

(e) Further information

e. To pass information on position or time a climb to the next higher FL is acceptable or a clearance for higher FLs is requested when inclusion in a position report message is not appropriate

1. Content and Data sequence

(a) Flight identification (additionally state frequency when using HF)

(b) Requested or Acceptable FLs

(c) at position or time

f. To pass information or make a request in plain language that does not conform with the content of other message format. No message designator is required as this will be inserted by the ground station.

1. Content and Data sequence

(a) Flight identification (additionally state frequency when using HF)

(b) General information or request in plain language and format free.

g. If the estimated time for the next position, as last reported to ATC, has changed by 2 minutes or more, a revised estimate must be transmitted to the ATS unit concerned as soon as possible.

h. A "When Able Higher" (WAH) report must be provided by all flights entering New York MNPSA and Santa Maria OCA.

1. WAH reports on entering other NAT OCAs is optional but useful and may be requested by any OAC. The WAH report includes the time or location the flight will be ABLE to accept the next higher flight level. More than one level may be quoted if that information is available. Should an aircraft desire to register a request for one or more future step climbs the word "REQUEST" must be substituted for the word "ABLE" in the report. It should be noted that ATC acknowledgement of a WAH report (and any included request) is NOT a clearance to change altitude.

i. Report immediately on reaching any new cruising level following a reclearance or completing a step climb etc.

WEATHER DEVIATION PROCEDURES FOR OCEANIC-CONTROLLED AIRSPACE

a. The pilot shall inform ATC when weather deviation is no longer required, or when a weather deviation has been completed and the aircraft has returned to its cleared route.

b. The pilot should contact ATC and request clearance to deviate from track or route, advising the extent of the deviation requested. The flight crew will use whatever means is appropriate (i.e., CPDLC and/or voice) to communicate during a weather deviation.

1. ATC should take one of the following actions:

(a) when appropriate separation can be applied, issue clearance to deviate from track or route; or

(b) (3) request the pilot's intentions.

2. The pilot should take the following actions:

(a) comply with the ATC clearance issued; or

(b) advise ATC of intentions and execute the procedures detailed below.

c. Actions to be taken if a revised ATC clearance cannot be obtained

(a) Originally cleared track or route center line

(1) East 000° - 179° magnetic

[a] DESCEND 300 ft (90 m)

[b] CLIMB 300 ft (90 m)

(2) West 180° - 359° magnetic

[a] CLIMB 300 ft (90 m)

[b] DESCEND 300 ft (90 m)

OPERATIONAL EQUIPMENT

For Description and requirements within the NAT MNPS airspace refer to the Canadian Air Traffic Control Pages.

SPECIAL PROCEDURES FOR IN-FLIGHT CONTINGENCIES IN OCEANIC AIRSPACE ICAO DOC 4444, SECTION 15.2

Introduction

1. Although all possible contingencies cannot be covered, these procedures provide for the more frequent cases such as:

a. Inability to comply with assigned clearance due to meteorological conditions.

b. En-route diversion across the prevailing traffic flow; and

c. Loss of, or significant reduction in, the required navigation capability when operating in an airspace where the navigation performance accuracy is a prerequisite to the safe conduct of flight operations, or pressurization failure.

2. General Procedures

1. If an aircraft is unable to continue the flight in accordance with its ATC clearance, a revised clearance shall be obtained, whenever possible, prior to initiating any action.

2. If prior clearance cannot be obtained, the following contingency procedures should be employed until a revised clearance is received. In general terms, the aircraft should be flown at an offset level and on an offset track where other aircraft are less likely to be encountered. Specifically, the pilot shall:

a. Leave the cleared track or ATS route by initially turning at least 30 degrees to the right or to the left, in order to establish and maintain a parallel, same direction track or ATS route offset 5 NM (9.3 km). The direction of the turn should be based on one or more of the following factors:

1) aircraft position relative to any organized track or ATS route system;

2) the direction of flights and flight levels allocated on adjacent tracks;

3) the direction to an alternate airport;

4) any strategic lateral offset being flown; and

5) terrain clearance.

b. Maintain a watch for conflicting traffic both visually and by reference to ACAS (if equipped), leaving ACAS in RA mode at all times, unless aircraft operating limitations dictate otherwise;

c. turn on all aircraft exterior lights (commensurate with appropriate operating limitations);

d. keep the SSR transponder on at all times and, when able, squawk 7700, as appropriate and, if equipped with ADS-B or ADS-C, select the appropriate emergency functionality;

e. as soon as practicable, advise air traffic control of any deviation from their assigned clearance;

f. use means as appropriate (ie. voice and/or CPDLC) to communicate during a contingency or emergency;

g. if voice communications are used, the radiotelephony distress signal (MAYDAY) or urgency signal (PAN PAN) preferably spoken three times, shall be used, as appropriate;

h. when emergency situations are communicated via CPDLC, the controller may respond via CPDLC. However, the controller may also attempt to make voice contact with the aircraft;

i. establish communications with and alert nearby aircraft by broadcasting on the frequencies in use and at suitable intervals on 121.5 MHz (or, as a backup, on the inter-pilot air-to-air frequency 123.45 MHz): aircraft identification, the nature of the distress condition, intention of the pilot, position (including the ATS route designator or the track code, as appropriate) and flight level; and

j. the controller should attempt to determine the nature of the emergency and ascertain any assistance that may be required. Subsequent ATC action with respect to that aircraft shall be based on the intentions or the pilot and overall traffic situation.

3. Actions to be taken once offset from track:

- a) operation within a parallel track system;
- b) the potential for user preferred routes (UPR's) parallel to the aircraft's track or ATS route;
- c) the nature of the contingency (e.g. aircraft system malfunction; and
- d) weather factors (e.g. convective weather at lower flight levels).

4. If possible, maintain the assigned flight level until established on the 9.3 km (5.0 NM) parallel, same direction track or ATS route offset. If unable, initially minimize the rate of descent to the extent that is operationally feasible.

5. Once established on a parallel, same direction track or ATS route offset by 9.3km (5.0 NM), either:

- a) descend below FL 290, and establish a 150 m (500 ft) vertical offset from those flight levels normally used, and proceed as required by the operational situation or if an ATC clearance has been obtained, in accordance with the clearance; or
- b) establish a 150 m (500 ft) vertical offset (or 300 m (1000 ft) vertical offset if above FL 410) from those flight levels normally used, and proceed as required by the operational situation, or if ATC clearance has been obtained, in accordance with the clearance.

COMMON PROCEDURES FOR RADIO COMMUNICATION FAILURE

The following procedures are intended to provide general guidance for North Atlantic (NAT) aircraft experiencing a communication failure. These procedures are intended to complement and not supersede state procedures/regulations. It is not possible to provide guidance for all situations associated with a communications failure.

a. General

1. The flight crew of an aircraft experiencing a two-way ATS communications failure should operate the SSR transponder on identity Mode A Code 7600 and Mode C.
2. When so equipped, an aircraft should use SATVOICE Communications to contact the responsible aeradio station via special telephone numbers/short codes.
3. If the aircraft is not equipped with SATVOICE then the flight crew should attempt to use VHF to contact any (other) ATC facility or another aircraft, inform them of the difficulty and request that they relay formation to the ATC facility with which communications are intended.
4. The inter-pilot air-to-air VHF frequency, 123.450 MHz, may be used to relay position reports via another aircraft.
5. In view of the traffic density in the NAT Region, flight crews of aircraft experiencing a two way ATS communications failure should broadcast regular position reports on the inter-pilot frequency 123.450 MHz until such time as communications are re-established.
6. Due to the potential length of time in Oceanic Airspace, it is strongly recommended that a flight crew experiencing communications failure whilst still in European domestic airspace does not enter the Shanwick Oceanic Control Area.

b. Communications failure prior to entering NAT Oceanic Airspace

1. If operating with a received and acknowledged oceanic clearance, the flight crew shall enter oceanic airspace at the cleared oceanic entry point, level and speed and proceed in accordance with the received and acknowledged oceanic clearance. Any level or speed changes required to comply with the oceanic clearance shall be completed in domestic airspace within the vicinity of the oceanic entry point.
2. If operating without a received and acknowledged oceanic clearance, the flight crew shall enter oceanic airspace at the first oceanic entry point level and speed, as contained in the filed flight plan and proceed via the filed flight plan route to landfall. That first oceanic level and speed shall be maintained to landfall.

c. Communications failure prior to exiting NAT Oceanic Airspace

1. Cleared on filed flight plan route:

(a) The flight crew shall proceed in accordance with the last received and acknowledged oceanic clearance to the last specified oceanic route point, normally landfall, then continue on the filed flight plan route. Maintain the last assigned oceanic level and speed to landfall. After passing the last specified oceanic route point, the pilot shall conform with the relevant State procedures/regulations.

(b) The pilot shall maintain the last assigned oceanic level and speed to landfall. After passing the last specified oceanic route point, the pilot shall conform with the relevant State procedures/regulations.

2. The flight crew shall proceed in accordance with the last received and acknowledged oceanic clearance to the last specified oceanic route point, normally landfall. After this point, rejoin the filed flight plan route by proceeding directly to the next significant point ahead of the track of the aircraft as contained in the filed flight plan. Where possible use published ATS route structures, then continue on the flight plan route. Maintain the last assigned oceanic level and speed to the last specified oceanic route point. After passing this point conform with the relevant State procedures/regulations.

d. Summary of Operational Procedures Required following Loss of Air/Ground ATS Communications in the NAT Region

1. Equipment Failure before receiving an oceanic clearance Divert or fly the flight plan route, speed and initial planned oceanic level to landfall.

2. Blackout encountered (in an HF comms Domestic ATC environment) before receiving an oceanic clearance Continue at Domestic cleared level and follow flight planned route and speed to landfall.

3. Equipment Failure or Blackout after receiving an oceanic clearance Fly that clearance to landfall.

OPERATIONAL APPROVAL AND AIRCRAFT SYSTEM REQUIREMENTS FOR FLIGHTS IN THE NAT HIGH LEVEL AIRSPACE (HLA)

Flight crews may fly across the North Atlantic within NAT High Level Airspace (HLA) only if they are in possession of the appropriate NAT HLA and RVSM approvals issued by the State of Registry of the aircraft or by the State of the operator. The Minimum Equipment List (MEL) for operations must be strictly observed. For complete information and further guidance to regulatory material relating to North Atlantic aircraft operations refer to the NAT Doc 007 "NORTH ATLANTIC OPERATIONS AND AIRSPACE MANUAL" - (www.icao.int/EURNAT/).

a. Description and Requirements:

1. NAT HLA is that volume of airspace between flight level (FL) 285 and FL 420 within the oceanic control areas of Bodo Oceanic, Gander Oceanic, New York Oceanic East, Reykjavik, Santa Maria and Shanwick, excluding the Shannon and Brest Ocean Transition Areas

2. If a flight experiences an equipment failure PRIOR to departure which renders the aircraft non-DLM compliant, the flight should re-submit a flight plan so as to remain clear of the NAT regional DLM airspace.

3. Horizontal Navigation Requirements for unrestricted NAT HLA Airspace Operations

(a) The navigation system accuracy requirements for NAT MNPSA/HLA operation should only be based on the PBN specifications, RNP 10 (PBN application of RNAV 10) or RNP 4 (see ICAO PBN Manual Doc. 9613). Although when granting consequent approval for operations in MNPSA/NAT HLA, States should take account of the RNP 10 time limits for aircraft equipped with dual INS or inertial reference unit (IRU) systems. All approvals issued after 04 February 2016 must be designated as "NAT HLA" approvals. State approval of unrestricted operation in the NAT HLA may presently be granted to an aircraft equipped as follows:

(1) With at least TWO fully serviceable Long Range Navigation Systems (LRNSs).

[a] A LRNS may be one of the following:

" One navigation system using the inputs from one or more Inertial Reference System (IRS) or any other Sensor System complying with the NAT HLA requirement.

[b] Each LRNS must be capable of providing to the flight crew a continuous indication of the aircraft position relative to desired track.

[c] It is also highly desirable that the navigation system employed for the provision of steering guidance is capable of being coupled to the auto-pilot.

(2) Time-based longitudinal separations between subsequent aircraft following the same track (in-trail) and between aircraft on intersecting tracks in the NAT HLA airspace are assessed in terms of differences in ATAs/ETAs at common points. The time-based longitudinal separation minima currently used in the NAT HLA airspace are thus expressed in clock minutes. The maintenance of in-trail separations is aided by the application of the Mach Number Technique. However, aircraft clock errors resulting in waypoint ATA errors in position reports can lead to an erosion of actual longitudinal separations between aircraft. It is thus vitally important that the time-keeping device intended to be used to indicate waypoint passing times is accurate, and is synchronized to an acceptable UTC time signal before commencing flight in NAT HLA airspace. In many modern aircraft, the Master Clock can only be reset while the aircraft is on the ground. Thus the Pre-flight Procedures for any NAT HLA operation must include a UTC time check and resynchronization of the aircraft Master Clock (typically the FMS). The following are examples of acceptable time standards:

[a] GPS (corrected to UTC). Available at all times via approved on-board GPS (TSO-C129) equipment.

[b] WWV (NIST - Fort Collins, Colorado) H24 on 2500, 5000, 10000, 15000 and 20000 kHz (AM/SSB).

[c] CHU (NRC - Ottawa, Canada) H24 on 3330, 7850 and 14670 kHz (SSB).

[d] All times given in UTC and every minute within specified periods.

4. Altimetry Equipment required for operation in RVSM Airspace

(a) TWO independent operational primary altimetry systems;

(b) One Automatic Altitude Control System;

(c) Standard pre-flight checks of altimeters are required. At least two primary altimeters must agree at all times within plus or minus 200 ft. At intervals of approx one hour, crosschecks between the primary altimeters should be made.

b. Aircraft with triple system installed, with only TWO systems operational, can proceed normally. For aircraft with only TWO operational systems, the following guidance is offered in case of system failure.

1. North Atlantic

(a) One System (of two operational systems) Fails Before Take-Off Delay departure until repair is possible If the remaining system is fully operative, the Pilot may file a new Flight Plan using the SPECIAL ROUTES as described under paragraph D or obtain a clearance above or below NAT HLA airspace.

(b) ONE System (of two operational systems) Fails Before the OCA Boundary is Reached. The flight crew should consider:

- (1) Landing at a suitable aerodrome before the boundary or returning to the aerodrome of departure.
- (2) Diverting via one of the special routes as described under Para 4.
- (3) Obtaining a re-clearance above or below NAT HLA airspace.

(4) Note: A revised Oceanic ATC clearance will be issued after co-ordination between all the OACs concerned. Should the Organized Track System at the time of the incident extend to the Northern part of the NAT Region, the aircraft concerned may be required to accept a lower than optimum flight level in its revised Oceanic Clearance, especially during peak traffic periods. The above guidance material in no way relieves the pilot from the obligation to take the best possible course of action under the prevailing circumstances.

(c) ONE System (of two operational systems) Fails After the OCA Boundary is Crossed. The flight crew should normally continue in accordance with the Oceanic Clearance already received, appreciating that the reliability of the total navigation system has been significantly reduced. However, the flight crew should:

- (1) Assess the prevailing circumstances (e.g. performance of the remaining system, remaining portion of the flight in NAT HLA airspace, etc.).
- (2) Prepare a proposal to ATC with respect to prevailing circumstances (e.g. request clearance above or below NAT HLA airspace, turn-back, obtain clearance to fly along one of the SPECIAL ROUTES, etc.).
- (3) Advise and consult with ATC as to the most suitable action.
- (4) Obtain appropriate re-clearance prior to any deviation from the last acknowledged Oceanic Clearance. When the flight continues in accordance with its original clearance, the pilot should begin a careful monitoring program:
- (5) Take special care in the operation of the remaining system bearing in mind that routine methods of error checking are no longer available.
- (6) Check main and stand-by compass systems frequently against the information which is still available.
- (7) Check performance record of remaining equipment, and if in doubt regarding its performance and/or reliability, the following procedures should be considered:

[a] Attempting visual sighting of other aircraft or their contrails which may provide a track indication.

[b] Calling the appropriate OAC for information on other aircraft adjacent to the aircraft's estimated position and/or calling on VHF to establish contact with such aircraft (preferably same track/level) to obtain from them useful information (e.g. drift, groundspeed, wind details etc.).

(d) The Remaining System Fails After Entering NAT HLA Airspace

- (1) Immediately notify ATC
- (2) Make best use of procedures specified in iii) 7., (a) and (b) above
- (3) Keep a special look-out for possible conflicting aircraft and make maximum use of external lights.
- (4) If no instructions are received from ATC within a reasonable period: consider climbing/descending 500ft / 150m, broadcast action on 121.5 MHz, and advise ATC as soon as possible.

(e) Should the computer element of the Navigation System fail, the basic output of the IRS (LAT/LONG, drift and ground speed) should be available unimpaired. Providing a suitable plotting chart is onboard and the cleared route has been plotted: Extract mean true tracks between waypoints. Use the basic IRS/GPS outputs to adjust heading to maintain mean track and calculate ETAs. At intervals of not more than 15 minutes plot LAT/LONG position on the chart and adjust heading to regain track.

c. In-Flight RVSM Procedures and Contingencies:

1. Prior to entry into NAT HLA airspace, check to ensure the two primary altimeters are reading within 200 feet of each other (or lesser value if specified in your aircraft's flight manual). Conduct this check while at level flight. You should also note the stand-by altimeter reading. The readings of the primary and standby altimeters should be recorded to be available for use in any possible contingency situations.

2. Within NAT HLA airspace, one automatic altitude-control system should be operative and engaged throughout the cruise. This system should only be disengaged when it is necessary to re-trim the aircraft, or when the aircraft encounters turbulence and operating procedures dictate. When passing waypoints, or at intervals not exceeding 60 minutes (whichever occurs earlier), or on reaching a new cleared flight level, a cross-check of primary altimeters should be conducted. If at any time the readings of the two primary altimeters differ by more than 200 ft, the aircraft's altimeter system should be considered defective and ATC must be so informed. It is essential in the NAT HLA that flight crews not using CPDLC/ADS-C always report to ATC immediately on leaving the current cruising level and on reaching any new cruising level.

3. The Strategic Lateral Offset Procedure (SLOP) is now a standard operating procedure throughout the North Atlantic (NAT) Region. This procedure mitigates collision risk and wake turbulence encounters. Pilots conducting oceanic flight within the NAT Region with automatic offset programming capability are recommended to fly centerline or 1 or 2 NM right of centerline. Aircraft shall not apply SLOP below FL285 in the Reykjavik CTA and Bodo OCA. The introduction of very accurate aircraft

navigation systems, along with sophisticated flight management systems, has drastically reduced the number of risk bearing lateral navigation errors reported in NAT airspace. Paradoxically, the capability of aircraft to navigate to such a high level of accuracy has led to a situation where aircraft on the same track but at different levels, are increasingly likely to be in lateral overlap. This results in an increased risk of collision if an aircraft departs from its cleared level for any reason. SLOP reduces risk by distributing aircraft laterally. It is applicable within the New York Oceanic, Gander Oceanic, Shanwick Oceanic, Santa Maria Oceanic, Nuuk and Reykjavik Flight Information Regions, and within the Bodo Oceanic Flight Information Region when flights are operated more than 185 km (100 NM) seaward from the shoreline. SLOP conforms to direction in the ICAO Procedures for Air Navigation Services-Air Traffic Management (PANS-ATM, Doc 4444, 16.5) and is subject to the following guidelines:

(a) Aircraft without automatic offset programming capability must fly the centerline.

(b) Aircraft able to perform offsets in tenths of nautical mile should do so as it contributes to risk reduction.

(c) It is recommended that flight crews of aircraft capable of programming automatic offsets should randomly select flying centerline or an offset. In order to obtain lateral spacing from nearby aircraft (i.e. those immediately above and/or below), flight crews should use whatever means are available (e.g. ACAS/TCAS, communications, visual acquisition, GPWS) to determine the best flight path to fly.

(d) An aircraft overtaking another aircraft should offset within the confines of this procedure, if capable, so as to minimize the amount of wake turbulence for the aircraft being overtaken.

(e) For wake turbulence purposes, flight crews should fly one of the offset positions. Flight crews may contact other aircraft on the air-to-air channel, 123.450, as necessary, to coordinate the best wake turbulence mutual offset option.

(f) Pilots may apply an offset outbound after the oceanic entry point and must return to centerline before the oceanic exit point, unless otherwise authorized by the appropriate ATS authority or directed by the appropriate ATC unit.

(g) There is no ATC clearance required for this procedure and it is not necessary that ATC be advised.

(h) Voice Position reports should be based on the waypoints of the current ATC clearance and not the offset positions.

(i) Aircraft shall not apply SLOP below FL285 in the Reykjavik CTA and Bodo OCA.

(j) Aircraft shall not apply SLOP for flights operating along T9 and T290 and shall maintain along route centerline.

4. Turbine-engined aircraft having a maximum certificated take-off mass exceeding 5,700 kg or authorized to carry more than 19 passengers are required to carry ACAS II in the NAT region. The technical specifications for ACAS II are contained in ICAO Annex 10 Volume IV. Compliance with this requirement can be achieved through the implementation of traffic alert and collision avoidance system (TCAS) Version 7.1 as specified in RTCA/DO-185B or EUROCAE/ED-143.

d. No aircraft should use these routes unless specifically authorized by the State of Registry or state of the operator as appropriate.

1. Aircraft with SHORT RANGE navigation equipment plus ONE operational LONG RANGE navigation equipment.

(a) ROUTES Europe to/from Canada via Greenland/Iceland

(1) Minimum acceptable operational navigation equipment VOR/DME and ADF plus:

[a] one Inertial Navigation System (INS) ;

[b] one Global Navigation Satellite System (GNSS); or

[c] one navigation system using the inputs from one or more Inertial Reference System (IRS) or any other sensor system complying with the NAT HLA requirement.

[d] Each LRNS must be capable of providing to the flight crew with a continuous indication of the aircraft position relative to desired track.

[e] It is highly desirable that the navigation system employed for the provision of steering guidance is capable of being coupled to the auto-pilot.

(2) Approved SPECIAL ROUTES:

[a] ATSIX - 61N 1234W - ALDAN - KFV (1.)

[b] RATSU - ALDAN - KFV (2.)

[c] GOMUP - 60N 15W - 61N 1630W - BREKI - KFV (3.)

[d] MOXAL - RATSU (4.)

[e] OSKUM - RATSU (4.)

[f] KFV - SOPEN - DA - SF - IKNOG - YFB (4.)

[g] KFV - EPENI -63N 30W - 61N 40W - OZN (4.)

[h] OZN - 59N 50W - AVUTI - PRAWN - YDP (4.)

[i] OZN - 59N 50W - CUDDY - PORGY - HO (4.)

[j] OZN - 58N 50W - HOIST - YZR (4.)

[k] SF (Kangerlussuaq) - DARUB (67N 60W) - YXP (4.)

[l] KU (Kook Islands) - EPMAN (66N 60W) - YXP (4.)

[m] KU (Kook Islands) - 64N 60W - MUSVA (64N 63W) - YFB (4.)

[n] RE (Reykjaneskoli) - 6930N 2240W - CP (4.)

“ 4.) Continuous VHF coverage exists on these routes at FL310 and above.

(b) ROUTES UK/Spain/Portugal to/from Azores and Madeira

(1) Approved SPECIAL ROUTES with Minimum acceptable operational navigation equipment according to Para 4, a), ii) above

[a] ADVAT - T290 - GELPO (VHF, HF and ADS-B required)

[b] Routings between the Azores, Funchal, Porto Santo and the Portuguese mainland.

2. Aircraft with ONLY SHORT RANGE navigation equipment

(a) ROUTES Europe to/from Iceland

(1) Minimum acceptable operational navigation equipment:- VOR/DME and ADF

(2) Approved SPECIAL ROUTES:

[a] VALDI - G3 - MY - ING - KFV

[b] Note: The above Special Routes should also be considered when partial loss of long range navigation capacity occurs prior to take-off or prior to entry into NAT HLA airspace. In this latter case a revised Flight Plan must be filed and ATC clearance obtained.

3. Aircraft that do not meet NAT HLA requirements may be allowed to operate in NAT HLA if the following conditions are satisfied:

(a) The aircraft is being provided with ATS Surveillance service

(b) Direct controller-pilot VHF voice communication is maintained; and

(c) The aircraft has a certified installation of equipment providing it the ability to navigate along the cleared track.

e. Climb/Descent through RVSM Levels

1. NAT HLA approved aircraft that are not approved for RVSM operation will be permitted, subject to traffic, to climb/descend through RVSM levels in order to attain cruising levels above or below RVSM airspace. Flights should climb/descend continuously through the RVSM levels without stopping at any intermediate level and should “Report leaving” current level and “Report reaching” cleared level. Such aircraft are also permitted to flight plan and operate at FL430 either Eastbound or Westbound above the NAT HLA.

2. ATC may provide special approval for a NAT HLA approved aircraft that is not approved for RVSM operation to fly in the NAT HLA provided that the aircraft:

(a) is on a delivery flight, or

(b) was RVSM approved but has suffered an equipment failure and is being returned to its base for repair and/or re-approval, or

(c) This service, as explained above, will not be provided to aircraft without approval for NAT HLA operations. It must be noted that the provision of this service is intended exclusively for the purposes listed above and is not the means for an operator or flight crew to circumvent the RVSM approval process. Operators or flight crews are required to provide written justification for the request, upon completion of the flight plan, to the NAT Central Monitoring Agency (CMA). Any suspected misuse of the exceptions rule above, regarding RVSM operation, will be reported and will therefore be subject to follow-up action by the State of Registry or State of the operator as applicable.

3. Some flight planning systems cannot generate a flight plan through RVSM airspace unless the “W” designator is inserted in item 10 (equipment). For a flight which has received this special approval, it is of utmost importance that the “W” is removed prior to transmitting the ICAO Flight Plan to ATC. ATC will use the equipment block information to apply either 1000 ft or 2000ft separation. Additionally, flight crews of any such non-RVSM flights operating in RVSM airspace should include the phraseology “Negative RVSM” in all initial calls on ATC frequencies, requests for flight level changes, read-backs of flight level clearances within RVSM

airspace and read-back of climb or descent clearances through RVSM airspace.

WEATHER REPORTING

In accordance with ICAO Annex 3, aircraft are no longer required to provide voice reports of MET observations of wind speed and direction nor outside air temperature. When an ATS unit establishes an event contract with an aircraft to provide ADS-C position reports, it may also establish an additional periodic report contract (e.g. with a 30 min interval). Such ADS-C periodic reports, unlike event reports, contain wind and temperature data and thereby satisfy the MET authorities requirements for the provision of MET data. However, it must be appreciated, that any such automated MET Reports do not include information on any observations of special or non-routine significant meteorological phenomena, such as moderate/severe turbulence or icing, volcanic ash, thunderstorms, etc. Therefore any flight crew providing position reports via datalink, who encounters any such significant meteorological phenomena should report this information via voice or, if appropriate, via a CPDLC free text downlink message. The format to be used for the reporting of such observations should, where appropriate, be by reference to geographical co-ordinates.

CONTINGENCY SITUATIONS AFFECTING ATM PROVISION IN THE NAT REGION

In the anticipation of situations arising which might result in the partial or total disruption of Air Traffic Services within the NAT Region, NAT ATS Providers have developed arrangements which would, in such events, be put in place to ensure, as far as possible, the continued safety of air navigation. Such arrangements include required actions by pilots and operators of affected flights. These arrangements are detailed in the [Air Traffic Management Operational Contingency Plan - North Atlantic Region](#) (NAT Doc.006) www.icao.int/EURNAT/..... .
Operator and Pilots planning and conducting operations in North Atlantic region should ensure their familiarity with these arrangements and in particular with the actions expected of pilots in such contingency situations.

SELCAL PROCEDURES WITHIN NAT

All aircraft operating as IFR flights in the NAT region shall be equipped with a pressure- altitude reporting SSR transponder. Unless otherwise directed by ATC, flight crews flying in the NAT FIRs will operate transponders continuously in Mode A/C Code 2000, except that the last assigned code will be retained for a period of 30 minutes after entry into NAT airspace or after leaving a radar service area. Flight crews should note that it is important to change from the last assigned domestic code to the Mode A/C Code 2000 since the original domestic code may not be recognized by the subsequent Domestic Radar Service on exit from the oceanic airspace. One exception to this requirement should be noted. Because of the limited time spent in the NAT HLA, when flying on Route Tango 9, the change from the last assigned domestic code to Code 2000 should be made Northbound 10 minutes after passing BEGAS and Southbound 10 minutes after passing LASNO. It should be noted that this procedure does not affect the use of the special purpose codes (7500, 7600 and 7700) in cases of unlawful interference, radio failure or emergency. However, given the current heightened security environment flight crews must exercise CAUTION when selecting Codes not to inadvertently cycle through any of these special purpose codes and thereby possibly initiate the launching of an interception. Reykjavik ACC provides a radar control service in the south-eastern part of its area and consequently transponder codes issued by Reykjavik ACC must be retained throughout the Reykjavik OCA until advised by ATC.
New York Oceanic FIR: All aircraft transitioning into the West Atlantic Route System (WATRS) via fixed ATS routes must remain on the last ATC assigned beacon code.

PERFORMANCE BASED SEPARATION MINIMA IN NAT AIRSPACE

Overview

Performance based separation minima of 42.6km (23NM) lateral, 5 minutes and 55.5km (30NM)/93km (50NM) longitudinal predicated on PBCS and PBN, in accordance with ICAO Doc 4444 Procedures for Air Navigation Services - Air Traffic Management (PANS-ATM) has been implemented in the ICAO NAT Region.

Application

- The 55.5km (30NM) and 93km (50NM) longitudinal separation minima are between eligible aircraft pairs within the New York East and Santa Maria OCAs;
- The 5 minute longitudinal separation minimum is applied between eligible aircraft pairs within the Gander, Reykjavik, Santa Maria and Shanwick OCAs;
- The 42.6km (23NM) lateral separation minimum is applied between eligible aircraft pairs within the Gander, Reykjavik, Santa Maria, New York East (30NM lateral applied) and Shanwick OCAs.

NOTE: NAT Doc008 [Application of Separation Minima](#)™ Appendix A contains details of the separation minima applied in the North Atlantic Region.

Operator/Aircraft Eligibility

Operators are eligible to flight plan to operate on published PBCS tracks provided the flights are:

- Authorized for Required Navigation Performance 4 (RNP 4);
- Fitted with and operating FANS 1/A CPDLC and ADS-C ; and
- Authorized for RCP 240 and RSP 180.

Operators/aircraft not eligible for performance based separation may be permitted to:

- Infringe PBCS tracks at FL350 - FL390 (inclusive) at only one point (including Oceanic Entry Point/ Exit Point) i.e. cross but not join an OTS PBCS track, and;
- Climb or descend through levels FL350 - FL390 on a PBCS track provided the climb or descent is continuous.

For details of separation minima in NAT Airspace refer to Jeppesen ATC pages [PERFORMANCE BASED SEPARATION MINIMA IN NAT AIRSPACE](#) .

NORTH ATLANTIC (NAT) OCEANIC CLEARANCE PROCEDURES

New York ARTCC issues Oceanic Clearances to eastbound aircraft entering North Atlantic High Level Airspace (NAT HLA).

Due to continuing concerns associated with the non-adherence to, or incorrect execution of, Oceanic clearances and tactical reroutes, the FAA evaluated its current method of issuing an Oceanic Clearance by New York ARTCC. This included identifying several procedural changes that could be made to the method by which an Oceanic Clearance is issued in order to improve safety.

These procedural changes will not eliminate the issuance of any portion of the Oceanic Clearance and will satisfy the requirements contained in Nat Doc 007, Chapter 5, [Oceanic ATC Clearances](#). It is not the intent to remove any altitude or speed confirmation; only the re-issuing of the cleared route will be eliminated.

There are three components to an Oceanic Clearance: (1) route; (2) altitude; and (3) speed. New York ARTCC will use multiple methods to comply with the NAT

requirement to issue the three elements of an Oceanic Clearance.

Aircraft entering the New York ARTCC Oceanic CTA from a FAA facility:

The airport clearance which an aircraft receives on the ground at its departure aerodrome is considered to be the route portion of the Oceanic Clearance. Altitude and speed assignment will occur prior to entry into the New York ARTCC Oceanic CTA.

As is the current operating procedure, unsolicited en-route route, altitude or speed amendments may occur due to changing traffic situations. At all times, the last assigned route, altitude and speed are to be maintained and should be considered the new oceanic profile.

Having received all three components, the requirement to receive an oceanic clearance will have been met.

North American (NAM) region departures:

Aircraft departing airports close to an oceanic boundary will receive the route portion of their Oceanic Clearance from Clearance Delivery. At most major airports in North America, the route portion is up-linked to the flight deck using the Pre-departure Clearance (PDC) method. This is an automated means to transmit the flight plan on file with air traffic control directly to the flight crew. At airports without the use of PDC, clearances are relayed via voice.

Once airborne and within United States offshore RADAR airspace, aircraft will be assigned an oceanic altitude and Mach number. The oceanic altitude may or may not be the aircraft current cleared altitude.

Caribbean/South American (CAR/SAM) region departures:

For aircraft originating from airports within the CAR/SAM region, New York ARTCC will utilize the procedures outlined in 5.6 of NAT Doc 007 to fulfill the requirements of the route portion of an oceanic clearance. Once airborne and within United States offshore RADAR airspace, the aircraft will be assigned its oceanic altitude and Mach number.

Piarco FIR traffic:

Aircraft originating from airports within the CAR/SAM region and not entering a United States offshore RADAR sector will not be included in these changes at this time.

Piarco will continue to use existing procedures for these aircraft.

Canadian FIR traffic:

Aircraft originating from airports within the NAM region and not entering a United States offshore RADAR sector will not be included in these changes at this time.

Moncton ACC and Gander ACC will continue to use existing procedures for these aircraft.

If a route, speed or altitude change en-route is desired, then aircraft should make a request from the ATC unit in which they are operating. At all times, the last assigned route, altitude and speed are to be maintained.

In conjunction with this procedure, operators are encouraged to file in Item 15 of the FPL the coordinates of a track in lieu of the track identification letter (e.g. NATU).

Operators are reminded of the requirement to file an FPL and any subsequent changes with New York Oceanic at KZWYZOZX, along with any other ATC facilities that may require such filing.

NORTH ATLANTIC CROSSING CLEARANCE PROCEDURES AND FREQUENCIES

a. General

1. Various methods of obtaining oceanic clearances include:

- (a) use of published VHF clearance delivery frequencies;
- (b) by HF communications to the OACC through the appropriate radio station (in accordance with specified timeframes);
- (c) a request via domestic or other ATC agencies;
- (d) by data link, when arrangements have been made with designated airlines to request and receive clearances using on-board equipment (ACARS).

2. Oceanic clearances are required for all flights within NAT controlled airspace (at or above FL60). Flight crews should request oceanic clearances from the ATC responsible for the first OCA within which they wish to operate, following the procedures and the time-frame laid down in appropriate AIPs and NAT OPS Bulletins. Such clearances are applicable only from that entry point. To assist in optimum airspace utilization, when requesting an oceanic clearance the flight crew should:

- (a) Advise of any required changes to oceanic flight planned level, track, or speed
- (b) Advise the maximum acceptable flight level at the oceanic boundary
- (c) Advise of preferred alternative NAT track if applicable

3. When flight crews are requesting oceanic clearance, they are required to maintain contact on the control frequency, unless having received permission to leave the frequency. If an aircraft encounters an in-flight equipment failure relevant to the airspace, enroute to the NAT oceanic airspace, then the flight crew must advise ATC when requesting an oceanic clearance.

4. The flight crew should monitor the forward estimate for oceanic entry, and if this changes by 2 minutes or more, unless providing position reports via ADS-C, pass a revised estimate to ATC. As planned longitudinal spacing by these OACCs is based on the estimated times over the oceanic entry fix or boundary, failure to adhere to this ETA amendment procedure may jeopardize planned separation between aircraft, thus resulting in a subsequent re-clearance to a less economical track/flight level for the complete crossing. Any such failure may also penalize following aircraft. If any of the route, flight level or speed in the clearance differs from that flight planned, requested or previously cleared, attention may be drawn to such changes when the clearance is delivered (whether by voice or by data link). Flight crews should pay particular attention when the issued clearance differs from the flight plan.

5. If the entry point of the oceanic clearance differs from that originally requested and/or the oceanic flight level differs from the current flight level, the flight crew is responsible for requesting and obtaining the necessary domestic re-clearance to ensure that the flight is in compliance with its oceanic clearance when entering oceanic airspace.

6. If flight crews have not received their oceanic clearance prior to reaching the OCA boundary, they must follow the guidance provided in the appropriate State AIP.

7. Unless otherwise stated the oceanic clearance issued to each aircraft is at a specified flight level and cruise Mach number. Subsequent en route changes to flight level or Mach number should not be made without prior ATC clearance, except in an urgency situation (e.g. encountering unanticipated severe turbulence).

b. Abbreviated Clearances

1. An abbreviated clearance is issued by Air Traffic Services when clearing an aircraft to fly along the whole length of an organised track. The flight crew should confirm the current NAT track message by using the TMI number (including any appropriate alpha suffix) in the readback. There is no requirement for the flight crew to read back the NAT track coordinates. If any doubt exists as to the TMI or the NAT track coordinates, the flight crew should request the complete track coordinates. Similarly, if the flight crew cannot correctly state the TMI, confirmation will include NAT track coordinates in full and a full read back of those coordinates will be required.

2. If the term, "via flight plan route" is used when issuing an oceanic clearance, the flight crew is required to readback the full coordinates of the flight plan route, from the oceanic entry point to the exit point.

c. Oceanic Area Control Centers Specific Procedures

1. Shanwick OCA

(a) Oceanic Clearance (Westbound):

(1) Aircraft operating within the UK FIR/UIR and the northern part of the France UIR should request oceanic clearance from "Shanwick Oceanic" on VHF (VHF coverage depicted on chart). UK departures are to request clearance as soon as possible after departure.

(2) Aircraft overflying the UK FIR/UIR and the northern part of the France UIR are to request clearance when they consider that they are within the specified VHF coverage.

(3) Aircraft other than Jet should request clearance at least 40 minutes before the ETA for the OCA entry point.

(4) Flights routing via RATSU (61N 010W) do not require OCA clearance from Shanwick OCA. Therefore, aircraft intending to route via RATSU (61N 010W) must not contact Shanwick clearance delivery.

(5) Aircraft unable to contact "Shanwick Oceanic" on VHF, should request clearance on NAT HF frequencies at least 40 minutes before the ETA for the oceanic boundary and thereafter maintain a SELCAL watch for receipt of the oceanic clearance.

(6) Aircraft Communication Addressing and Reporting System (ACARS) equipped aircraft may request and receive their westbound oceanic clearance via data link, utilizing the Oceanic Clearance Link (OCL), for entry points on the Shanwick eastern boundary (from LUSEN to PASAS) without the requirement to contact Shanwick on RTF. Approval for the use of this system will be given by the Team Leader Asset Engineering Ops. Support at Shanwick Oceanic. This system should not be used by aircraft within 30 minutes of the Shanwick boundary; VHF or HF RTF should be used.

(7) Requests for oceanic clearance shall include:

[a] callsign;

[b] OCA entry point and ETA;

[c] requested MACH number and flight level;

[d] any change to flight plan affecting OCA;

[e] the highest acceptable flight level which can be maintained at the OCA entry point.

(8) Maintain a listening watch for receipt of the oceanic clearance. If successful Selcal check has been completed with the appropriate aeradio station, a Selcal watch should be maintained. Unless advised otherwise, use the following primary frequencies:

[a] VHF:

127.65 MHz for aircraft registered in states east of 30° West.

[b] HF:

Family H, I and J assigned on a tactical basis and coordinated between Shanwick Radio, adjoining NARTEL Radio Stations and Domestic ATC agencies.

(9) While in communication with Shanwick for oceanic clearance, aircraft must also maintain communication with the ATC authority for the airspace within which they are operating. Aircraft unable to contact Shanwick on VHF or on NARTEL HF should request the ATC authority for the airspace in which they are operating to relay their request for oceanic clearance to Shanwick.

(10) Due to the short flying times between Scottish and Irish aerodromes and the Shanwick OCA boundary, pilots may be required to request and receive an Oceanic Clearance prior to departure.

(11) Departures from Dublin, Weston and Casement (Baldonnel) airports request Oceanic clearance for all Oceanic entry points when airborne.

(12) Cork Departures, if flight planned to enter Shanwick airspace via OMOKO, TAMEL or LASNO require Oceanic clearance prior to departure. All other Oceanic entry, if the elapsed time to Shanwick Entry Point is 40 minutes or less, Oceanic clearance required prior to departure.

(13) Departures from Belfast Aldergrove, Belfast/City, Londonderry/Eglinton, Glasgow and Prestwick if flight planned to enter Shanwick at GOMUP or ETILO, oceanic clearance required prior to departure. If flight planned to enter Shanwick at all other entry points, request when airborne. Non-jet Departures request oceanic clearance when airborne.

(14) Departures from all other aerodromes, if the elapsed time to the Shanwick entry point is 40 minutes, or less, oceanic clearance required prior to departure.

(15) Oceanic clearances should be requested from Shanwick Oceanic via OCL. Shannon ACC will, on request, obtain Oceanic clearance from Shanwick Oceanic and pass the clearance to the flight prior to departure.

(16) Shannon Departures should contact Shannon ACC on Phone or on 121.7 MHz 40 minutes before ETD to request Oceanic Clearance. Pilots should contact Shannon ACC on 121.7 MHz at least 15 minutes before start up, to obtain Oceanic Clearance.

(17) Aircraft departing Dublin, Weston and Casement (Baldonnel) airports planned to enter NAT Airspace should request Oceanic Clearance when airborne using OCL or Shanwick Radio 127.9 MHz or HF.

(18) REMARKS:

[a] TMI IS 099 AND OPERATORS ARE REMINDED TO INCLUDE THE TMI NUMBER AS PART OF THE OCEANIC CLEARANCE READ BACK.

[b] OPERATORS ARE REMINDED THAT ADS-C AND CPDLC IS MANDATED FOR LEVELS 350-390 IN NAT AIRSPACE.)

SHANNON OCEANIC TRANSITION AREA (SOTA), NORTHERN OCEANIC TRANSITION AREA (NOTA)

Parts of the Shanwick OCA are designated as the Shannon Oceanic Transition Area (SOTA) and the Northern Oceanic Transition Area (NOTA). NOTA airspace is included in the NAT HLA and hence NAT HLA airspace requirements are still applicable from FL285 to FL420 in NOTA. However, SOTA is not included in the NAT HLA. Therefore flights within SOTA routing such that they are subject to an Oceanic Clearance, are required to be NAT HLA MNPS Approved. ATC service is provided by Shannon ACC via VHF. If unable to contact on VHF use HF. In the Westbound NAT OTS signal Shanwick OAC promulgates the track structure(s) applicable together with such other information as may be considered useful for operators to identify the route to be flown. The domestic landfall points KESIX, OSBOX, BEGID, SOVED, MOGLO, NETKI, KOKIB, BEXET, OLGON, GISTI, RILED, XETBO, LEKVA, ELBOX, EPUNA, ATSUR, BIMGO, NASBA, GUNSO and EMPER, which are associated with the OCA exit points, are promulgated in three eastbound OTS message. If an eastbound NAT flight is rerouted via an oceanic landfall different to that filed in the Flight Plan, the flight may route DCT from the new landfall to the original filed exit point from Irish airspace. Westbound NAT random flights and NAT OTS flights operating in the SOTA or NOTA, designated as MET reporting flights are to treat 8W for SOTA and 10W for NOTA as a mid-point and 15W as a designated reporting point. The 8W respectively 10W and 15W MET reports are to be given with the 15W position report to Shanwick on HF. Eastbound flights are not required to make MET reports when flying in the SOTA/NOTA. Flight plans required for the SOTA/NOTA should be addressed to the IFPS addresses EUCHZMFP and EUCBZMFP. Flights requesting a change to their Oceanic Clearance must:

a. If East of 10Å°W make their request to Shanwick on VHF/HF or CPDLC otherwise

b. If West of 10Å°W make their request to Shannon ACC on VHF.

Flights not subject to an oceanic clearance, which flight plan to route through SOTA/NOTA, are not subject to MNPS approval.

BREST OCEANIC TRANSITION AREA (BOTA)

Part of the Shanwick OCA is designated as the Brest Oceanic Transition Area (BOTA). BOTA is not included in the NAT HLA. Hence only flights routing such that they are subject to an Oceanic Clearance, are required to be NAT HLA MNPS Approved. ATC service in BOTA is provided by Brest ATC. Eastbound flights may be given more direct routes by Brest UAC after passing 0845W meridian. The request for the Oceanic Clearance may be relayed by Brest ATC when unable to contact Shanwick on VHF or HF.

REYKJAVIK OCA

Aircraft entering the Reykjavik CTA shall request an oceanic clearance prior to entering the Reykjavik OCA as follows:

a. On data link in accordance with the document "ACARS Data Link Oceanic Clearance" published in Jeppesen ATC-Chapter, ATC-Data-Atlantic.

b. From Iceland Radio on HF.

c. Aircrews approaching Reykjavik airspace from the Scottish and Stavanger areas can contact Iceland Radio on primary 127.85, secondary 129.625 to obtain their oceanic clearance.

Reykjavik cannot issue oceanic clearances until coordination data has been received from the adjacent air traffic control centre and the flight data has been activated within the Reykjavik Flight Data Processing System (FDPS). This occurs a certain time before the aircraft is estimated to enter the Reykjavik CTA and the time interval varies depending on the control area from which the aircraft enters the Reykjavik CTA. Aircraft that are not data link equipped and are unable to contact Iceland Radio on HF/VHF should request the ATC authority for the airspace in which they are operating to relay their request for oceanic clearance to Reykjavik Centre. Pilots should always endeavour to obtain oceanic clearance prior to entering Reykjavik OCA; however if any difficulty is encountered the pilot should not hold while awaiting clearance unless so directed by ATC. In such circumstances, pending receipt of the oceanic clearance, the aircraft should continue to maintain the flight level cleared by the current control authority. Aircraft obtaining an oceanic clearance from Iceland Radio on HF/VHF should also maintain communication with the ATC authority for the airspace in which they are operating. When operating in BIRD and BGGL FIRs, aircrew unable to make position reports via VHF or CPDLC, ADS-C or FMC are expected to use HF or SATCOM telephone if so equipped. SATCOM voice communications should be made to Iceland radio, short code is 425105. The numbers 425101 and 425103, are connected at Reykjavik ATC centre and are valid for aircrew encountering emergencies.

BODO OCA

Flights entering the NAT Region through BodÅ, OCA shall request their Oceanic Clearance from Polaris ACC (BodÅ,) on FREQ 127.725 MHZ, through BodÅ, Radio on appropriate HF frequencies, or through the appropriate data link service. Oceanic clearance via data link should be requested at least 30 minutes prior to Oceanic entry. For VHF/HF, at least 20 minutes prior to entry. Departures from aerodromes situated close to the NAT Region boundary shall request Oceanic clearance as soon as possible after departure. Pilots should always endeavour to obtain an Oceanic Clearance prior to entering Bodo Oceanic Control Area, however, if any difficulty is encountered, the pilot should not hold while awaiting clearance unless directed to do so by ATC. All aircraft within Bodo OFIR are required to maintain listening watch, SELCAL or aural, with Bodo Radio on HF Family D. While in communication with Bodo Oceanic Control or Bodo Radio for Oceanic Clearance, aircraft must also maintain communication with the ATC authority for the airspace within which they are operating.

SANTA MARIA OCA

Oceanic Clearances may be requested via the Santa Maria Oceanic Clearance Delivery (OCD) data link service or via the available voice services on VHF, HF or

SATVOICE. All operators shall request their Oceanic Clearance at least 40 minutes before the ETO for the Santa Maria OCA boundary. Flights departing from aerodromes located in Lisbon FIR, which are close to Santa Maria OCA boundary, shall request Oceanic Clearance as soon as possible after departure. Flights departing from Madeira Islands entering Santa Maria OCA via IRKID or ABALO are exempted of being leveled at oceanic entry point as long as prior authorization is obtained from Lisbon ATC or Santa Maria ATC. Flights departing from Azores Islands will receive the Oceanic Clearance in a three step process. The appropriate Tower must be informed of the intended flight level for oceanic crossing and will issue an initial flight level clearance. After departure, Santa Maria Radar will assure the climb to the approved final level. The pilot will only receive the oceanic route and speed clearance later on, usually through Santa Maria Radio on HF. Pilots should always endeavour to obtain Oceanic Clearance prior to entering Santa Maria Oceanic Control Area; however if any difficulty is encountered the pilot should not hold while waiting for the clearance, unless so instructed by ATC.

GANDER OCA

Unless otherwise advised by ATC, the following oceanic clearance delivery procedures are in effect daily between 2330 and 0730 UTC (DST 2230 and 0630 UTC) for all eastbound oceanic flights that transit the Gander domestic FIR/CTA. Clearance delivery frequencies are published daily in the Remarks section on the eastbound NAT track message. During published clearance delivery hours, pilots are to contact Gander Clearance Delivery on the frequency designated for their oceanic entry point. Pilots should contact Clearance Delivery when they are within 200 NM of the specified clearance delivery frequency location. In the event that contact cannot be established, pilots are to advise ATC on the assigned control frequency. The following frequencies and frequency locations will normally be used: 135.45 - NATASHQUAN (CYNA) (N50 11 W061 47) YNA VOR 128.45 - ALLANSM ISLAND (N46 50 W055 47) 128.70 - CHURCHILL FALLS (CZUM) (N53 35 W064 14) UM NDB 135.05 - STEPHENVILLE (N48 34 W058 40) YJT VOR 119.42 - SYDNEY (N46 09 W060 03) YQY VOR 132.025 - BREVOORT (N63 20 W064 08) 134.20 - KUUJJUAQ (CYVP) (N58 05 W068 25) YVP VOR. Operators who do not receive the NAT track message are to contact Gander Clearance Delivery when they are within 200 NM of the frequency location. In the event that contact cannot be established, pilots are to advise ATC on the assigned control frequency.

Pilots are to maintain a continuous listening watch on the assigned control frequency while obtaining the oceanic clearance.

Flights that are equipped to request and receive solicited electronic oceanic clearances are not required to contact Clearance Delivery if an electronic clearance is received and confirmed successfully. Confirmation is the receipt of the following message: CLA RECEIVED CLEARANCE CONFIRMED END OF MESSAGE. If the above message is not received, data link oceanic clearances must be verified, either with Gander Clearance Delivery, during published hours, or on the control frequency, outside of published hours.

For detailed Gander data link oceanic clearance Delivery (OCD) crew procedures refer to the NAT OPS Bulletins <http://www.paris.icao.int/>.

Example of a data link oceanic clearance (on a NAT track): CLX 1259 060224 CZQX CLRNC 026 ABC123 CLRD TO LFPG VIA NEEKO NAT W NEEKO 54N050W 56N040W 57N030W 57N020W PIKIL SOVED FM NEEKO/1348 MNTN F330 M082 END OF MESSAGE

Example of a Gander eastbound NAT track message: TZA466 241302 FF BIRDZQZZ 241302 CZQXZQZX (NAT-1/3 TRACKS FLS 320/400 INCLUSIVE APR 25/0100Z TO APR 25/0800Z PART ONE OF THREE PARTS- R ALLRY 51/50 52/40 52/30 53/20 MALOT GISTI EAST LVLS 320 330 340 350 360 370 380 390 400 WEST LVLS NIL NAR N389B N383B -

REMARKS:

- a. TMI IS 151 AND OPERATORS ARE REMINDED TO INCLUDE THE TMI NUMBER AS PART OF THE OCEANIC CLEARANCE READ BACK.
- b. OPERATORS ARE REMINDED THAT ADS-C AND CPDLC IS MANDATED FOR LEVELS 350-390 IN NAT AIRSPACE.
- c. 80 PERCENT OF NAVIGATIONAL ERRORS RESULT FROM POOR COCKPIT PROCEDURES. ALWAYS CARRY OUT PROPER WAYPOINT PROCEDURES.)

GANDER OCA Communications:

- a. All flights operating in the Gander OCA should report on international air-to-ground frequencies.
- b. In addition to maintaining a listening watch on the appropriate en route frequency, flights shall establish and maintain communication with Gander, Moncton or Montreal as soon as possible in accordance with the following.

1. At FL 290 or above, when within 200 NM communication should take place over frequency:

- (a) Torbay (YYT) VORDME - 134.70, 132.05, 230.30, 128.175, 125.07 or 245.00 for oceanic entry/exit points (OEP) BOBTU to MUSAK;
- (b) Gander (YQX) VORTAC - 133.90, 294.50, 125.90, 132.60 or 342.90 for OEPs JOOPY to UMESI;
- (c) St. Anthony (YAY) VORDME - 134.30, 124.725 or 128.60 for OEPs TUDEP to MELDI;
- (d) Goose Bay (YYR) VORDME - 133.42, 127.675 or 132.40 for OEPs LOMSI to ENNSO;
- (e) Hopedale (HO) NDB - 132.65 or 128.32 for OEPs DORYY to TOXIT;
- (f) Saglek (N5828 W06239) - 135.325 for OEPs SAVRY to LIBOR;
- (g) Brevoort (N6320 W06408) - 124.825 for OEPs KETLA to AVPUT;
- (h) Wabush (YWK) VORDME - 134.00;
- (i) Sept-Iles (YZV) VORDME - 126.32;
- (j) Natash (YNA) VORDME - 118.875;
- (k) Stephenville (YJT) VORDME - 133.55;
- (l) Grindstone (YGR) VORDME - 132.80;
- (m) Sydney (YQY) VORTAC - 132.75, 133.70, 133.30 or 125.25;

2. At FL 280 or below, when within 150 NM communication should take place over frequency:

- (a) Torbay (YYT) VORDME - 133.15 or 227.30 for coastal fixes BOBTU to JOOPY;
- (b) Gander (YQX) VORTAC - 132.10 or 289.40 for coastal fixes IBERG to UMESI;
- (c) St. Anthony (YAY) VORDME - 133.00 or 371.90 for coastal fixes TUDEP to MELDI;
- (d) Goose Bay (YYR) VORDME - 120.40 or 294.50 for coastal fixes LOMSI to HOIST;
- (e) Hopedale (HO) NDB - 135.40 for coastal fixes PORGY to MOATT;
- (f) Allans Island (N4650 W05547) - 134.90;
- (g) Stephenville (YJT) VORDME - 132.30 or 247.00.

GANDER OCEANIC TRANSITION AREA (GOTA)

Electronic RCL Messages Through GOTA

Pilots submitting an RCL must use an oceanic entry and exit points located within GOTA and a boundary fix along the Montreal CTA boundary. Oceanic entry and exit points and details are available in the Gander Data Link Oceanic Clearance Delivery Crew Procedures document. Flight crews submitting an RCL based on Montreal CTA boundary (e.g. IKMAN, MIBNO) will cause system errors and may affect the ocean profile.

NEW YORK OCA EAST

For flights planning to enter the NAT directly from the New York Oceanic East FIR, the IFR clearance to destination received at the departure aerodrome constitutes the route portion of the oceanic clearance. Once airborne, and prior to entry into the NAT, aircraft will be assigned an altitude and a speed (if required) by New York Center.

The receipt of all three elements of an oceanic clearance: route, flight level, and speed constitutes the complete oceanic clearance. A subsequent change to any element (s) of the oceanic clearance does not alter the others. Flights entering Canadian Domestic airspace from the New York Oceanic East FIR and then subsequently entering the NAT require a complete oceanic clearance. Flights entering the southern portion of New York East FIR from Piarco CTA will be issued all three components of the oceanic clearances prior to entering New York OCA.

Currently 50NM lateral separation standard is implemented in the New York Oceanic East FIR between aircraft meeting RNP 10 or RNP 4 specifications.

New York ARTCC

For details refer to Jeppesen ATC page "NORTH ATLANTIC (NAT) OCEANIC CLEARANCE PROCEDURES".